



**EUROPEAN SPACE AGENCY**  
DIRECTORATE OF HUMAN SPACEFLIGHT AND OPERATIONS  
HSO-GI



# **EXTERNAL USER INTERFACE CONTROL DOCUMENT (EUICD)**

EGOS Data Dissemination  
System (EDDS)



Reference: EGOS-GEN-EDDS-ICD-1001  
Version: 7.0  
Date: 2014-12-17

<b>Document Title:</b>	External User Interface Control Document (EUICD)		
<b>Document Reference:</b>	EGOS-GEN-EDDS-ICD-1001		
<b>Document Version:</b>	7.0	<b>Date:</b>	2014-12-17
<b>Abstract</b>			

**Approval Table:**

Action	Name	Function	Signature	Date
Prepared by:	EDDS Team	Author		2014-12-17
Verified by:	Miriam Saltzer	Application Quality Assurance Engineer (EDDS)		2014-12-17
Approved by:	Rui Santos	Technical Officer		2014-12-17

**Authors and Contributors:**

Name	Contact	Description	Date
M. Hawkshaw	<a href="mailto:michael.hawkshaw@cgi.com">michael.hawkshaw@cgi.com</a>	Author	2014-12-17
R. Ots	<a href="mailto:rauno.ots@cgi.com">rauno.ots@cgi.com</a>	Contributer	2014-12-17
L. Kimmel	<a href="mailto:lauri.kimmel@cgi.com">lauri.kimmel@cgi.com</a>	Contributer	2014-12-17
D. Sarjas	<a href="mailto:deiwin.sarjas@cgi.com">deiwin.sarjas@cgi.com</a>	Contributer	2014-12-17

**Distribution List:**

© COPYRIGHT EUROPEAN SPACE AGENCY, 2014

The copyright of this document is vested in the European Space Agency. This document may only be reproduced in whole or in part, stored in a retrieval system, transmitted in any form, or by any means e.g. electronically, mechanically or by photocopying, or otherwise, with the prior permission of the Agency.

**Document Change Log**

Issue	Date	Description
1.0	2007-04-13	Update in line with PDR outcome.
2.0	2010-10-11	Issue of document for PA delivery
2.1	2011-03-29	Issue for Final Acceptance Delivery
3.0	2011-09-09	Issue for EDDS v1.1.0i1
3.1	2011-10-24	Issue for EDDS v1.1.0i2
3.2	2011-11-14	Issue for EDDS v1.1.0i3
3.3	2012-02-29	Issue for EDDS v1.1.1i1
3.4	2012-04-04	Issue for EDDS v1.1.1i2
3.5	2012-05-18	Issue for EDDS v1.1.2i1
3.6	2012-09-17	Issue for EDDS v1.2.0i1
3.7	2012-09-27	Issue for EDDS v1.2.0i2
3.8	2012-10-12	Issue for EDDS v1.2.0i3
3.9	2013-03-21	Issue for EDDS v1.2.1i1
3.10	2013-04-10	Issue for EDDS v1.2.1i2
4.0	2013-06-21	Issue for EDDS v1.2.2i1

Issue	Date	Description
5.0	2013-12-03	Issue for EDDS v1.3.0i1
6.0	2014-05-28	Issue for EDDS v1.4.0i1
7.0	2014-12-17	Issue for EDDS v1.5.0i1

**Document Change Record**

<b>DCR No:</b>	00	<b>Originator:</b>	
<b>Date:</b>		<b>Approved by:</b>	
<b>Document Title:</b>	External User Interface Control Document (EUICD)		
<b>Document Reference:</b>	EGOS-GEN-EDDS-ICD-1001		
<b>Page</b>	<b>Paragraph</b>	<b>Reason for Change</b>	

# TABLE OF CONTENTS

<b>1. INTRODUCTION.....</b>	<b>1</b>
1.1 PURPOSE.....	1
1.2 SCOPE.....	1
1.3 DOCUMENT OVERVIEW.....	1
<b>2. REFERENCES.....</b>	<b>3</b>
2.1 APPLICABLE DOCUMENTS.....	3
2.2 REFERENCE DOCUMENTS.....	3
<b>3. GLOSSARY.....</b>	<b>4</b>
3.1 ACRONYMS.....	4
3.2 DEFINITION OF TERMS.....	5
<b>4. SOFTWARE OVERVIEW.....</b>	<b>6</b>
4.1 EDDS SERVICES OVERVIEW.....	6
4.1.1 Authentication Services.....	6
4.1.2 Batch Service.....	6
4.1.3 Stream Service.....	7
4.1.4 User Management Service.....	7
4.2 EDDS INTERFACE OVERVIEW.....	7
4.2.1 EDDS Web Service Interface.....	8
4.2.2 Stream Web Service Interface.....	8
4.2.3 Email Interface.....	8
4.2.4 Delivery Manager Interface.....	8
4.3 CLIENT APPLICATIONS OVERVIEW.....	8
4.3.1 EDDS Client Application.....	9
4.3.2 Email Server.....	9
4.3.3 Delivery Manager.....	9
4.3.4 Request Submitter.....	9
<b>5. DATA TYPES.....</b>	<b>15</b>
5.1 PACKET.....	15
5.2 PARAMETER.....	16
5.3 REPORT.....	16
5.4 ARCHIVED FILES.....	16
5.5 ACKNOWLEDGEMENT.....	17
5.6 REQUEST AND RESPONSE MAPPINGS.....	17
<b>6. FORMATS.....</b>	<b>18</b>
6.1 EDDS BINARY.....	20
6.1.1 EDDS Raw Header.....	20
6.1.2 Packet Data.....	21
6.1.3 GDDS Binary File Example.....	25
6.2 XML.....	28
6.2.1 Packet.....	28
6.2.2 Parameter.....	28
6.2.3 Report.....	28
6.2.4 Archived Files.....	29
6.2.5 File System.....	29
6.2.6 Acknowledgement.....	29
6.3 XML TRANSFORM.....	30
6.4 XFDU.....	30
6.5 TDRS SPREADSHEET.....	30
6.6 ASCII.....	30
6.7 BINARY.....	32
6.7.1 Archive File.....	32
6.7.2 File System.....	32

6.7.3	Google Proto Buffers.....	32
<b>7.</b>	<b>NAMING CONVENTIONS.....</b>	<b>42</b>
7.1	REQUEST ID CONVENTION.....	42
7.2	RESPONSE ID CONVENTION.....	42
<b>8.</b>	<b>DELIVERY.....</b>	<b>43</b>
8.1	DELIVERY MECHANISM.....	43
8.1.1	File Server.....	43
8.1.2	EDDS Server.....	43
8.1.3	Stream.....	43
<b>9.</b>	<b>WEB SERVICES DESCRIPTION.....</b>	<b>44</b>
9.1	WEB SERVICE INTRODUCTION.....	44
9.2	PORT TYPES.....	44
9.2.1	EDDS Port Type.....	44
9.3	MESSAGES.....	58
9.3.1	message accountRequest.....	59
9.3.2	message accountRequestResponse.....	59
9.3.3	message authenticationFault.....	59
9.3.4	message authorizationFault.....	59
9.3.5	message batchRequest.....	60
9.3.6	message batchRequestResponse.....	60
9.3.7	message cancel.....	61
9.3.8	message suspend.....	61
9.3.9	message resume.....	61
9.3.10	message cancelResponse.....	61
9.3.11	message suspendResponse.....	62
9.3.12	message resumeResponse.....	62
9.3.13	message checkSession.....	62
9.3.14	message checkSessionResponse.....	63
9.3.15	message checkUserPassword.....	63
9.3.16	message checkUserPasswordResponse.....	63
9.3.17	message deleteData.....	63
9.3.18	message deleteDataResponse.....	64
9.3.19	message deleteRequest.....	64
9.3.20	message deleteRequestResponse.....	64
9.3.21	message getCatalogue.....	64
9.3.22	message getCatalogueResponse.....	65
9.3.23	message getDataspaces.....	65
9.3.24	message getDataspacesResponse.....	65
9.3.25	message getFarcCatalogue.....	65
9.3.26	message getFarcCatalogueResponse.....	66
9.3.27	message getHistoricalLog.....	66
9.3.28	message getHistoricalLogResponse.....	66
9.3.29	message getJobs.....	67
9.3.30	message getJobsResponse.....	67
9.3.31	message getJobsWithStatus.....	67
9.3.32	message getJobsWithStatusResponse.....	67
9.3.33	message getMissionDetails.....	68
9.3.34	message getMissionDetailsResponse.....	68
9.3.35	message getMissions.....	68
9.3.36	message getMissionsResponse.....	69
9.3.37	message getMissionsAndDomains.....	69
9.3.38	message getMissionsAndDomainsResponse.....	69
9.3.39	message getParamDefinitions.....	69
9.3.40	message getParamDefinitionsResponse.....	70
9.3.41	message getRequest.....	70
9.3.42	message getRequestResponse.....	70
9.3.43	message getResponse.....	70

9.3.44	message getResponseResponse .....	71
9.3.45	message getRoles .....	71
9.3.46	message getRolesResponse .....	71
9.3.47	message getStatus .....	71
9.3.48	message getStatuses .....	72
9.3.49	message getStatusesResponse .....	72
9.3.50	message getStatusResponse .....	72
9.3.51	message getTransformations .....	73
9.3.52	message getTransformationsResponse.....	73
9.3.53	message getUserAccountDetails .....	73
9.3.54	message getUserAccountDetailsResponse .....	73
9.3.55	message getUserQuota.....	74
9.3.56	message getUserQuotaResponse.....	74
9.3.57	message getUsers .....	74
9.3.58	message getUsersResponse .....	74
9.3.59	message hasPermissionToSeeAllUsers.....	75
9.3.60	message logIn .....	75
9.3.61	message logInResponse .....	75
9.3.62	message logOut .....	76
9.3.63	message passwordExpiredFault.....	76
9.3.64	message permissionToSeeAllUsersResponse .....	76
9.3.65	message requestFault .....	76
9.3.66	message reSubmit.....	77
9.3.67	message reSubmitResponse.....	77
9.3.68	message sessionFault .....	78
9.3.69	message streamRequest .....	78
9.3.70	message streamRequestResponse .....	79
9.3.71	message startStreamData .....	79
9.3.72	message startStreamDataResponse .....	79
9.3.73	message stopStreamData .....	79
9.3.74	message stopStreamDataResponse .....	80
9.4	BINDINGS .....	80
<b>10.</b>	<b>E-MAIL INTERFACE.....</b>	<b>87</b>
10.1	DATA ELEMENTS .....	87
10.2	MESSAGE DESCRIPTION .....	87
10.3	COMMUNICATION PROTOCOL .....	87
10.4	ERRORS .....	87
<b>11.</b>	<b>FILE SERVER INTERFACE .....</b>	<b>88</b>
11.1	DATA ELEMENTS .....	88
11.2	MESSAGE DESCRIPTION .....	88
11.3	COMMUNICATION PROTOCOL.....	88
11.4	ERRORS .....	88
<b>12.</b>	<b>CLIENT API.....</b>	<b>89</b>
12.1	EDDS WEB SERVICES CLIENT API.....	90
12.1.1	Instantiating .....	90
12.1.2	Session Management .....	90
12.1.3	Issuing Requests .....	90
12.1.4	Managing Requests .....	90
12.1.5	Special Requests.....	91
12.1.6	Utility Methods for Requests .....	91
12.1.7	Utility Methods for User Management .....	91
12.1.8	Edds Client API – code examples .....	92
12.2	EDDS PUSH NOTIFICATIONS CLIENT .....	99
12.2.1	Security .....	99
12.2.2	Example: Register notifications listener.....	99
12.3	EDDS UTILITY METHODS .....	100
12.3.1	Decoding EDDS Param Binary format.....	100

12.4	DEPENDENCIES .....	100
<b>APPENDIX A ACKNOWLEDGEMENT DATA TYPE.....</b>		<b>102</b>
A.1	COMPLEXTYPE ACKNOWLEDGEMENTPART.....	102
A.2	COMPLEXTYPE ACKNOWLEDGEMENTPARTLIST .....	103
A.3	COMPLEXTYPE DARCRETRIEVEREFERENCE.....	103
A.4	COMPLEXTYPE FILESYSTEMNAMEREFERENCE.....	103
A.5	COMPLEXTYPE PARAMETERSAMPLEREFERENCE.....	104
A.6	COMPLEXTYPE RESPONSEFILEENTRY.....	104
A.7	COMPLEXTYPE RETRIEVALREFERENCE .....	105
A.8	COMPLEXTYPE SAMPLEREFERENCE.....	105
A.9	COMPLEXTYPE SAMPLETIMESTAMP .....	105
A.10	SIMPLETYPE RESPONSEFILESTATUS .....	105
<b>APPENDIX B AUTHENTICATION DATA TYPE.....</b>		<b>107</b>
B.1	COMPLEXTYPE USERCREDENTIALS.....	107
<b>APPENDIX C BATCH REQUEST DATA TYPE.....</b>		<b>108</b>
C.1	COMPLEXTYPE ARCHIVECATALOGUE.....	108
C.2	COMPLEXTYPE ARCHIVEFILE .....	109
C.3	COMPLEXTYPE ARCHIVESUBSCRIPTION .....	110
C.4	COMPLEXTYPE ARCHIVESUBSCRIPTIONNOTIFICATION .....	111
C.5	COMPLEXTYPE BATCHREQUEST.....	112
C.6	COMPLEXTYPE BEHAVIOURSTATE .....	112
C.7	COMPLEXTYPE BEHAVIOURSTATES .....	113
C.8	COMPLEXTYPE CANCELPART .....	113
C.9	COMPLEXTYPE CANCELPARTLIST.....	113
C.10	COMPLEXTYPE CATALOGUEREQUEST .....	114
C.11	COMPLEXTYPE CATALOGUERESPONSE.....	114
C.12	COMPLEXTYPE CATALOGUERESPONSEELEMENT.....	115
C.13	COMPLEXTYPE DATAREQUEST .....	115
C.14	COMPLEXTYPE DATASPACESREQUEST .....	117
C.15	COMPLEXTYPE DEFAULTFILESERVERREQUEST.....	117
C.16	COMPLEXTYPE DETAILEDBEHAVIOURSTATE.....	117
C.17	COMPLEXTYPE DOWNLOADLIST .....	118
C.18	COMPLEXTYPE FARCATALOGUEREQUEST .....	118
C.19	COMPLEXTYPE INTERRUPTPART .....	118
C.20	JOBIDPART.....	119
C.21	COMPLEXTYPE JOBIDPARTLIST .....	119
C.22	COMPLEXTYPE JOBLISTIDPART .....	119
C.23	COMPLEXTYPE LISTSTRING .....	119
C.24	PACKETSTATISTICSRESPONSE .....	120
C.25	COMPLEXTYPE PARAM.....	120
C.26	COMPLEXTYPE PARAMDEFINITION .....	121
C.27	COMPLEXTYPE PARAMDEFINITIONLIST.....	121
C.28	COMPLEXTYPE PARAMDEFINITIONLISTELEMENT.....	122
C.29	COMPLEXTYPE PARAMDEFINITIONRESPONSE .....	122
C.30	COMPLEXTYPE PARAMPACKETINSTANCE .....	123
C.31	COMPLEXTYPE PARAMPACKETINSTANCES.....	124
C.32	COMPLEXTYPE PARAMPREVIEW .....	124
C.33	COMPLEXTYPE PARAMPREVIEWLIST.....	125
C.34	COMPLEXTYPE PARAMPREVIEWLISTELEMENT.....	125
C.35	COMPLEXTYPE PARAMPREVIEWRESPONSE .....	125
C.36	COMPLEXTYPE PARAMREPRESENTATIONSAMPLE .....	126
C.37	COMPLEXTYPE PARAMREPRESENTATIONSAMPLES .....	126
C.38	COMPLEXTYPE PARAMRESPONSE .....	127
C.39	COMPLEXTYPE PARAMSAMPLELIST .....	127
C.40	COMPLEXTYPE PARAMSAMPLELISTELEMENT .....	129
C.41	COMPLEXTYPE PARAMSTATISTICLISTELEMENT .....	130
C.42	COMPLEXTYPE PARAMSTATISTICS.....	130

C.43	COMPLEXTYPE PARAMSTATISTICSLIST .....	131
C.44	COMPLEXTYPE PARAMSTATISTICSRESPONSE .....	131
C.45	COMPLEXTYPE PKTEV .....	132
C.46	COMPLEXTYPE PKTEVRAW .....	133
C.47	COMPLEXTYPE PKTEVSTATISTICS .....	134
C.48	COMPLEXTYPE PKTRAWRESPONSE.....	134
C.49	COMPLEXTYPE PKTRAWRESPONSEELEMENT .....	135
C.50	COMPLEXTYPE PKTTC .....	135
C.51	COMPLEXTYPE PKTTCRAW .....	136
C.52	COMPLEXTYPE PKTTCSTATISTICS.....	137
C.53	COMPLEXTYPE PKTTM.....	138
C.54	COMPLEXTYPE PKTTMGAPREPORT .....	139
C.55	COMPLEXTYPE PKTTMGAPREPORTELEMENT .....	140
C.56	COMPLEXTYPE PKTTMRAW .....	141
C.57	COMPLEXTYPE PKTTMSTATISTICS.....	142
C.58	COMPLEXTYPE REQUESTMESSAGEPART .....	142
C.59	COMPLEXTYPE RESPONSE.....	143
C.60	COMPLEXTYPE RESPONSEDATA .....	144
C.61	COMPLEXTYPE RESPONSEDATAELEMENT.....	144
C.62	COMPLEXTYPE RESPONSEPART.....	144
C.63	COMPLEXTYPE RESUMEPART.....	145
C.64	COMPLEXTYPE RESUMEPARTLIST .....	145
C.65	COMPLEXTYPE SMONPARAM .....	146
C.66	COMPLEXTYPE SMONPARAMRESPONSE .....	146
C.67	COMPLEXTYPE SMONPARAMRESPONSELIST.....	146
C.68	COMPLEXTYPE SMONPARAMRESPONSELISTELEMENT .....	147
C.69	COMPLEXTYPE STATISTICSRECORD.....	147
C.70	COMPLEXTYPE SUSPENDPART.....	148
C.71	COMPLEXTYPE SUSPENDPARTLIST .....	148
C.72	COMPLEXTYPE TRANSFORMATIONSLIST .....	148
C.73	COMPLEXTYPE TRANSFORMATIONSREQUEST .....	149
C.74	COMPLEXTYPE VALIDITY.....	149
<b>APPENDIX D COMMON DATA TYPES .....</b>		<b>150</b>
D.1	COMPLEXTYPE APIDLIST .....	150
D.2	COMPLEXTYPE COMPLETION .....	150
D.3	COMPLEXTYPE CONTEXTPART.....	150
D.4	COMPLEXTYPE DELIVERYRANGE.....	151
D.5	COMPLEXTYPE DOMAINLIST .....	151
D.6	COMPLEXTYPE EMAILLIST .....	151
D.7	COMPLEXTYPE PACKETNAME .....	152
D.8	COMPLEXTYPE PACKETNAMELIST.....	152
D.9	COMPLEXTYPE P1LIST .....	153
D.10	COMPLEXTYPE P2LIST .....	153
D.11	COMPLEXTYPE REQUESTPOSTPROCESSING .....	153
D.12	COMPLEXTYPE RESPONSEFILES .....	153
D.13	COMPLEXTYPE SPIDLIST .....	154
D.14	COMPLEXTYPE SUBTYPELIST.....	154
D.15	COMPLEXTYPE TIME .....	154
D.16	COMPLEXTYPE TIMECHOICE .....	155
D.17	COMPLEXTYPE TIMERANGE .....	155
D.18	COMPLEXTYPE TIMEWINDOW.....	156
D.19	COMPLEXTYPE USER.....	156
D.20	SIMPLETYPE DATAACCESSDATAELEMENT .....	156
D.21	SIMPLETYPE DATACOMPRESSION .....	157
D.22	SIMPLETYPE DATAENCRYPTING.....	157
D.23	SIMPLETYPE DATASOURCE.....	158
D.24	SIMPLETYPE DOYDATE TIME.....	158
D.25	SIMPLETYPE NAMEPREFIXSUFFIXELEMENT.....	158
D.26	SIMPLETYPE OOLPARAMETERSTATE .....	159



D.27	SIMPLETYPE OOLRECORDTYPE.....	159
D.28	SIMPLETYPE OOLSTATE.....	159
D.29	SIMPLETYPE OPERATION.....	160
D.30	SIMPLETYPE ORDERBY.....	160
D.31	SIMPLETYPE PARAMVALIDITYSTATUS.....	160
D.32	SIMPLETYPE PRIVACYTAG.....	161
D.33	SIMPLETYPE SPIDSSPECIFIER.....	161
D.34	SIMPLETYPE STATE.....	161
<b>APPENDIX E DELIVERY DATA TYPE.....</b>		<b>163</b>
E.1	COMPLEXTYPE ACKDELIVERY.....	163
E.2	COMPLEXTYPE DELIVERY.....	163
E.3	COMPLEXTYPE EMAILDELIVERY.....	163
E.4	COMPLEXTYPE FILESERVERDELIVERY.....	164
E.5	COMPLEXTYPE SERVERDELIVERY.....	165
E.6	COMPLEXTYPE TARGETLOCATION.....	165
<b>APPENDIX F FILE SYSTEM DATA TYPES.....</b>		<b>167</b>
F.1	COMPLEXTYPE FILEFILTERENTRY.....	167
F.2	COMPLEXTYPE FILESYSTEMCATALOGUE.....	167
F.3	COMPLEXTYPE FILESYSTEMCATALOGUEFORMAT.....	168
F.4	COMPLEXTYPE FILESYSTEMFILE.....	168
F.5	COMPLEXTYPE FILESYSTEMFILECATALOGUE.....	169
F.6	COMPLEXTYPE FILESYSTEMFILECATALOGUEELEMENT.....	169
F.7	COMPLEXTYPE FILESYSTEMFILECATALOGUERESPONSE.....	170
F.8	COMPLEXTYPE FILESYSTEMFOLDERCATALOGUE.....	170
F.9	COMPLEXTYPE FILESYSTEMFOLDERCATALOGUEELEMENT.....	171
F.10	COMPLEXTYPE FILESYSTEMFOLDERCATALOGUERESPONSE.....	171
F.11	COMPLEXTYPE FILESYSTEMSUBSCRIPTION.....	172
F.12	COMPLEXTYPE FILESYSTEMSUBSCRIPTIONNOTIFICATION.....	173
<b>APPENDIX G FILTER DATA TYPE.....</b>		<b>174</b>
G.1	COMPLEXTYPE ARCHIVEFILEFILTER.....	174
G.2	COMPLEXTYPE ARCHIVEFILELIST.....	174
G.3	COMPLEXTYPE ARCHIVEFILELISTELEMENT.....	175
G.4	COMPLEXTYPE CATALOGUEFILTER.....	175
G.5	COMPLEXTYPE CATALOGUEFILTERLIST.....	175
G.6	COMPLEXTYPE CATALOGUEFILTERLISTELEMENT.....	176
G.7	COMPLEXTYPE EDDSUSAGEREPORTFILTER.....	176
G.8	COMPLEXTYPE EDDSUSAGEREPORTFILTERELEMENT.....	177
G.9	COMPLEXTYPE EDDSUSAGEREPORTFILTERKEYWORD.....	177
G.10	COMPLEXTYPE EVFILTERELEMENT.....	177
G.11	COMPLEXTYPE EVFILTERLIST.....	178
G.12	COMPLEXTYPE EVPACKETFILTER.....	178
G.13	COMPLEXTYPE EVSTREAMFILTERLIST.....	178
G.14	COMPLEXTYPE EVSTREAMFILTERLISTELEMENT.....	178
G.15	COMPLEXTYPE OOLDATAREPORTFILTER.....	179
G.16	COMPLEXTYPE OOLFILTERELEMENT.....	179
G.17	COMPLEXTYPE OOLFILTERKEYWORD.....	180
G.18	COMPLEXTYPE OOLFILTERLIST.....	181
G.19	COMPLEXTYPE OOLSTREAMFILTERKEYWORD.....	182
G.20	COMPLEXTYPE OOLSTREAMFILTERLIST.....	183
G.21	COMPLEXTYPE OOLSTREAMFILTERLISTELEMENT.....	183
G.22	COMPLEXTYPE PARAMFILTERKEYWORD.....	183
G.23	COMPLEXTYPE PARAMFILTERLIST.....	184
G.24	COMPLEXTYPE PARAMFILTERLISTELEMENT.....	184
G.25	COMPLEXTYPE PARAMPREVIEWFILTER.....	184
G.26	COMPLEXTYPE PARAMSTATISTICSFILTER.....	184
G.27	COMPLEXTYPE PARAMSTREAMFILTERKEYWORD.....	185
G.28	COMPLEXTYPE PARAMSTREAMFILTERLIST.....	185

G.29	COMPLEXTYPE PARAMSTREAMFILTERLISTELEMENT .....	185
G.30	COMPLEXTYPE PARAMTMFILTER .....	186
G.31	COMPLEXTYPE PKTEVFILTERKEYWORD.....	187
G.32	COMPLEXTYPE PKTEVSTREAMFILTERKEYWORD.....	187
G.33	COMPLEXTYPE PKTTCFILTERKEYWORD.....	188
G.34	COMPLEXTYPE PKTTCSTREAMFILTERKEYWORD.....	190
G.35	COMPLEXTYPE PKTTMFILTERKEYWORD .....	191
G.36	COMPLEXTYPE PKTTMGAPREPORTFILTER .....	192
G.37	COMPLEXTYPE PKTTMSTREAMFILTERKEYWORD .....	192
G.38	COMPLEXTYPE RAWEVPACKETFILTER .....	193
G.39	COMPLEXTYPE RAWPACKETFILTER .....	193
G.40	COMPLEXTYPE RAWTCPACKETFILTER.....	194
G.41	COMPLEXTYPE RAWTMPACKETFILTER.....	194
G.42	COMPLEXTYPE SMONPARAMFILTER.....	195
G.43	COMPLEXTYPE SMONPARAMFILTERKEYWORD.....	195
G.44	COMPLEXTYPE SMONPARAMFILTERLIST .....	195
G.45	COMPLEXTYPE SMONPARAMFILTERLISTELEMENT .....	195
G.46	COMPLEXTYPE TCFILTERELEMENT .....	196
G.47	COMPLEXTYPE TCFILTERLIST .....	196
G.48	COMPLEXTYPE TCPACKETFILTER .....	196
G.49	COMPLEXTYPE TcSTREAMFILTERLIST .....	197
G.50	COMPLEXTYPE TcSTREAMFILTERLISTELEMENT.....	197
G.51	COMPLEXTYPE TmFILTERELEMENT.....	197
G.52	COMPLEXTYPE TmFILTERLIST .....	197
G.53	COMPLEXTYPE TMPACKETFILTER .....	198
G.54	COMPLEXTYPE TmSTREAMFILTERLIST .....	198
G.55	COMPLEXTYPE TmSTREAMFILTERLISTELEMENT .....	198
G.56	SIMPLETYPE COMMANDSOURCE .....	198
G.57	SIMPLETYPE STAGESTATUS .....	199
G.58	SIMPLETYPE TcTIMEFILTERING .....	200
G.59	SIMPLETYPE TIMEFILTERING.....	200
G.60	SIMPLETYPE UPLINKMODE.....	200
<b>APPENDIX H     FORMAT DATA TYPE .....</b>		<b>201</b>
H.1	GROUP SPLITTABLEFORMAT .....	201
H.2	COMPLEXTYPE CATALOGUEFORMATTING.....	201
H.3	COMPLEXTYPE EDDSUSAGEREPORTFORMATTING .....	201
H.4	COMPLEXTYPE EVPACKETFORMATTING .....	202
H.5	COMPLEXTYPE PACKETFORMATTING .....	202
H.6	COMPLEXTYPE PACKETSTATISTICSFORMATTING .....	202
H.7	COMPLEXTYPE PARAMDEFINITIONFORMATTING.....	203
H.8	COMPLEXTYPE PARAMPREVIEWFORMATTING .....	203
H.9	COMPLEXTYPE PARAMSTATISTICSFORMATTING .....	203
H.10	COMPLEXTYPE PARAMTMFORMATTING.....	204
H.11	COMPLEXTYPE PARCRAWPACKETFORMATTING.....	204
H.12	COMPLEXTYPE REPORTFORMATTING .....	204
H.13	COMPLEXTYPE SMONPARAMFORMATTING .....	205
H.14	SIMPLETYPE ARCHIVEFILEFORMAT .....	205
H.15	SIMPLETYPE CATALOGUEFORMAT .....	205
H.16	SIMPLETYPE EDDSUSAGEREPORTFORMAT .....	205
H.17	SIMPLETYPE EVPACKETFORMAT .....	206
H.18	SIMPLETYPE PACKETFORMAT .....	206
H.19	SIMPLETYPE PACKETSTATISTICSFORMAT .....	206
H.20	SIMPLETYPE PARAMDEFINITIONFORMAT .....	206
H.21	SIMPLETYPE PARAMPREVIEWFORMAT .....	207
H.22	SIMPLETYPE PARAMSTATISTICSFORMAT .....	207
H.23	SIMPLETYPE PARAMTMFORMAT.....	207
H.24	SIMPLETYPE PARCRAWPACKETFORMAT.....	207
H.25	SIMPLETYPE REPORTFORMAT .....	208
H.26	SIMPLETYPE SMONPARAMFORMAT .....	208

<b>APPENDIX I</b>	<b>REPORT DATA TYPE</b>	<b>209</b>
I.1	COMPLEXTYPE DATAREQUESTBASE	209
I.2	COMPLEXTYPE EDDSUSAGEREPORT	209
I.3	COMPLEXTYPE EDDSUSAGEREPORTLIST	210
I.4	COMPLEXTYPE EDDSUSAGEREPORTLISTELEMENT	210
I.5	COMPLEXTYPE EDDSUSAGEREPORTRESPONSE	211
I.6	COMPLEXTYPE EVENTRECORDREPORT	212
I.7	COMPLEXTYPE EVENTRECORDREPORTLIST	212
I.8	COMPLEXTYPE EVENTRECORDREPORTLISTELEMENT	213
I.9	COMPLEXTYPE EVENTRECORDREPORTRESPONSE	213
I.10	COMPLEXTYPE OOLDATAREPORTLIST	214
I.11	COMPLEXTYPE OOLDATAREPORTRESPONSE	214
I.12	COMPLEXTYPE OOLDATAREPORTRESPONSEELEMENT	215
I.13	COMPLEXTYPE OOLRECORDREPORT	216
I.14	COMPLEXTYPE PKTTcREPORT	217
I.15	COMPLEXTYPE PKTTcREPORTLIST	217
I.16	COMPLEXTYPE PKTTcREPORTLISTELEMENT	218
I.17	COMPLEXTYPE CUSTOMFIELD	219
I.18	COMPLEXTYPE PKTTcREPORTPARAMETERLIST	219
I.19	COMPLEXTYPE PKTTcREPORTPARAMETERLISTELEMENT	220
I.20	COMPLEXTYPE PKTTcREPORTRESPONSE	220
I.21	COMPLEXTYPE PKTTmREPORT	221
I.22	COMPLEXTYPE PKTTmREPORTLIST	221
I.23	COMPLEXTYPE PKTTmREPORTLISTELEMENT	222
I.24	COMPLEXTYPE PKTTmREPORTRESPONSE	223
I.25	COMPLEXTYPE PKTTmGAPREPORTLIST	223
I.26	COMPLEXTYPE PKTTmGAPREPORTLISTELEMENT	223
I.27	COMPLEXTYPE PKTTmGAPREPORTRESPONSE	224
<b>APPENDIX J</b>	<b>SCHEDULE DATA TYPE</b>	<b>225</b>
J.1	COMPLEXTYPE ENDTIME	225
J.2	COMPLEXTYPE ONCESCHEDULE	225
J.3	COMPLEXTYPE REPEATINGCHEDULE	226
J.4	COMPLEXTYPE REPETITION	226
J.5	COMPLEXTYPE SCHEDULE	226
J.6	COMPLEXTYPE SCHEDULEONCE	227
J.7	COMPLEXTYPE SCHEDULEREPEATING	228
J.8	COMPLEXTYPE SCHEDULEWITHEXPIRY	228
<b>APPENDIX K</b>	<b>USER MANAGEMENT DATA TYPE</b>	<b>229</b>
K.1	COMPLEXTYPE ACCOUNTENABLEDDetails	229
K.2	COMPLEXTYPE ACCOUNTREQUEST	230
K.3	COMPLEXTYPE ACCOUNTREQUESTMESSAGEPART	231
K.4	COMPLEXTYPE CONTACTDETAILSELEMENT	231
K.5	COMPLEXTYPE CONTACTDETAILSLIST	231
K.6	COMPLEXTYPE DATAACCESSDATA	232
K.7	COMPLEXTYPE DATAACCESSSET	232
K.8	COMPLEXTYPE DATAACCESSLIST	232
K.9	COMPLEXTYPE GROUP	233
K.10	COMPLEXTYPE GROUPDATA	233
K.11	COMPLEXTYPE GROUPROLEASSIGNMENT	234
K.12	COMPLEXTYPE MISSION	234
K.13	COMPLEXTYPE MISSIONDATA	234
K.14	COMPLEXTYPE MISSIONDETAILSLIST	235
K.15	COMPLEXTYPE MISSIONSLIST	235
K.16	COMPLEXTYPE OPERATIONSET	235
K.17	COMPLEXTYPE OPERATIONSETDATA	236
K.18	COMPLEXTYPE QUOTASET	236
K.19	COMPLEXTYPE QUOTASETDATA	237
K.20	COMPLEXTYPE QUOTASETROLEASSIGNMENT	238

K.21	COMPLEXTYPE ROLE.....	238
K.22	COMPLEXTYPE ROLESLIST .....	238
K.23	COMPLEXTYPE USERACCOUNT .....	239
K.24	COMPLEXTYPE USERACCOUNTBASE.....	240
K.25	COMPLEXTYPE USERACCOUNTCREATE .....	242
K.26	COMPLEXTYPE USERACCOUNTDETAILS.....	244
K.27	COMPLEXTYPE USERATTRIBUTES.....	245
K.28	COMPLEXTYPE USERMISSIONELEMENT .....	245
K.29	COMPLEXTYPE USERQUOTADETAILS .....	246
K.30	COMPLEXTYPE USERQUOTADETAILSLIST.....	246
K.31	COMPLEXTYPE USERROLE.....	247
K.32	COMPLEXTYPE USERSLIST.....	247
K.33	SIMPLETYPE OPERATIONELEMENT.....	247
K.34	SIMPLETYPE USEROPERATIONELEMENT .....	248
<b>APPENDIX L STREAM REQUEST DATA TYPE.....</b>		<b>249</b>
L.1	COMPLEXTYPE OOLSTREAM .....	249
L.2	COMPLEXTYPE PARAMSTREAM.....	249
L.3	COMPLEXTYPE PKTEVSTREAM .....	250
L.4	COMPLEXTYPE PKTSTREAM .....	250
L.5	COMPLEXTYPE PKTTCSTREAM .....	251
L.6	COMPLEXTYPE PKTTMSTREAM.....	251
L.7	COMPLEXTYPE STREAMDATAREQUEST .....	252
L.8	COMPLEXTYPE STREAMREQUEST .....	252
L.9	COMPLEXTYPE STREAMREQUESTMESSAGEPART .....	252
<b>APPENDIX M EDDS PARAMETER SPREADSHEET.....</b>		<b>254</b>
M.1	TDRS LIKE SPREADSHEET.....	254
M.2	PRESTO PLOT STYLESHEET .....	254
<b>APPENDIX N GOOGLE PROTOCOL BUFFERS .....</b>		<b>255</b>
N.1	INTRODUCTION .....	255

## TABLE OF TABLES

TABLE 1 - DATA TYPE & SERVICE OVERVIEW .....	15
TABLE 2 – REQUEST AND RESPONSE MAPPINGS .....	17
TABLE 3 - DATA TYPE FORMATTING .....	19
TABLE 4 - STRUCTURE OF EDDS BINARY DATA.....	20
TABLE 5 - FORMAT OF THE EDDS FILE HEADER .....	20
TABLE 6 - TM PACKET RAW HEADER FIELDS .....	22
TABLE 7 - TM PACKET RAW DATA ELEMENT.....	22
TABLE 8 - POSSIBLE TC PACKET RAW HEADER FIELDS .....	23
TABLE 9 - TC PACKET RAW DATA ELEMENT .....	24
TABLE 10 - POSSIBLE EV PACKET RAW HEADER FIELDS .....	24
TABLE 11 - EV PACKET RAW DATA ELEMENT .....	25
TABLE 12 - EXAMPLE TM PACKET BINARY FORMAT .....	26
TABLE 13 - EXAMPLE TC PACKET BINARY FORMAT .....	28
TABLE 14 - EDDS USAGE REPORT .....	29
TABLE 15 – TC REPORT ASCII COLUMN OUTPUT.....	32
TABLE 16 – REQUEST ID CONVENTION .....	42
TABLE 17 – RESPONSE ID CONVENTION.....	42

## TABLE OF FIGURES

FIGURE 1 - INTERFACE OVERVIEW .....	8
-------------------------------------	---

# 1. Introduction

## 1.1 Purpose

This document defines the service interfaces available to clients of the EGOS Data Dissemination System (EDDS).

Note: In most cases, an XML schema file is associated to the interface. In the case of updates, the XML files shall be the first source of update. Only after the update of the XML schema file, the change can be reported back to the EUD document.

## 1.2 Scope

This document describes the service interfaces between the EDDS and its clients. The following interfaces are described:

- EDDS Web Services Interface
- Stream Web Service Interface

This document is a description of the interfaces detailing the common elements that are to be found for all missions. It is expected that other documentation will be available to describe mission-specific elements of the interfaces described.

The readership is expected to be software developers, ESA technical authorities with interest in the EDDS component and users of the EDDS.

It is expected that mission specific Data Definition Interface Documents (DDID) will be created based on the information given in this document (EUICD).

## 1.3 Document Overview

Section 1 - Introduction (this section) provides the purpose, scope and this document's overview.

Section 2 - References provides the list of reference documents.

Section 3 - Glossary provides a list of acronyms and terms used throughout this document.

Section 4 - Software Overview provides a brief description of the software system and its context.

Section 5 – Describes the data types that are supported by the interface.

Section 6 – Describes the formatting of the data provided through the interface.

Section 8 – Describes the Delivery mechanism provided by the EDDS.

Section 9 - Describes the underlying web service operations that provide service functionality.

Section 10 – Describes the EDDS Email interface

Section 11 – Describes the client hosted File Server interface

Section 12 – Describes the generic client Java API provided by the EDDS

Appendix A – Provides a list of XML schemas, which define the acknowledgement data types, as described in the acknowledgement.xsd.

Appendix B – Provides a list of XML schemas, which define the authentication data types, as described in the authentication.xsd.

Appendix C – Provides a list of XML schemas, which define the batch request data types, as defined in the batchRequest.xsd.

Appendix D – Provides a list of XML schemas, which define the common data types, as defined in the common.xsd.

Appendix E – Provides a list of XML schemas, which define the delivery data types, as defined in the delivery.xsd.

Appendix G – Provides a list of XML schemas, which define the filter data types, as defined in the filtered.xsd.

Appendix H – Provides a list of XML schemas, which define the format data types, as defined in the format.xsd.

Appendix I – Provides a list of XML schemas, which define the report data types, as defined in the report.xsd.

Appendix J – Provides a list of XML schemas, which define the schedule data types, as defined in the schedule.xsd.

Appendix K – Provides a list of XML schemas, which define the user management data types, as defined in the userrequest.xsd.

Appendix L – Provides a list of XML schemas, which define the stream data types, as defined in the streamrequest.xsd.

Appendix M – Provides info about the EDDS Parameter Spreadsheet.

## 2. References

### 2.1 Applicable documents

Ref.	Document Title	Issue and Revision, Date
[AD-1]	CCSDS, XML Formatted Data Unit (XFDU) Structure and Construction Rules.	BLUE BOOK 661.0-B.1, Set 2008
[AD-2]	Generic Data Disposition System (GDDS) Generic Data Delivery Interface Document DDID (EGOS-MCS-GDDS-1003) Appendix F	Issue 1.4, 2008-04-11

### 2.2 Reference documents

Ref.	Document Title	Issue and Revision, Date
[RD-1]	EDDS Client Software User Manual [EGOS-GEN-EDDS-SUM-1001]	Version 6.0 2014-12-17
[RD-2]	Multipurpose Internet Mail Extensions (MIME) Part One: Format of Internet Message Bodies [RFC 2045]	November 1996
[RD-3]	Web Services Definition Language (WSDL) 1.1 [ <a href="http://www.w3.org/TR/wsdl">http://www.w3.org/TR/wsdl</a> ]	2001-03-15
[RD-4]	MUST Architectural Design Document [no reference]	Version 1.1, 2006-01-13
[RD-5]	XSL Transforms (XSLT) Version 1.0 [ <a href="http://www.w3.org/TR/xslt">http://www.w3.org/TR/xslt</a> ]	1999-11-16
[RD-6]	Extensible Markup Language (XML) 1.0 (Fourth Edition) [ <a href="http://www.w3.org/TR/xml">http://www.w3.org/TR/xml</a> ]	2006-09-29
[RD-7]	SOAP Version 1.2 Part 1: Messaging Framework [ <a href="http://www.w3.org/TR/soap12-part1/">http://www.w3.org/TR/soap12-part1/</a> ]	2003-06-24
[RD-8]	Deleted	Deleted
[RD-9]	Deleted	Deleted
[RD-10]	SCOS-2000 Glossary, Definitions and Acronyms [EGOS-MCS-S2K-GLO-0001]	Version 1.7 2007-03-20
[RD-11]	Software Requirements Specification (SRS), EGOS Data Dissemination System (EDDS) [EGOS-GEN-EDDS-SRS-1001]	Version 10.0, 2014-12-17,
[RD-12]	Software Design Document (SDD), EGOS Data Dissemination System (EDDS) [EGOS-GEN-EDDS-SDD-1001]	Version 7.0, 2014-12-17
[RD-13]	Generic Data Disposition System (GDDS) Generic Data Delivery Interface Document (DDID) [EGOS-MCS-GDDS-1003]	Version 1.4, 2008-04-11
[RD-14]	TDRS External Interfaces Control Document [EGOS-MCS-S2K-ICD-0017]	Version 5.1, 2008-08-22
[RD-15]	EDDS Configuration and Installation Guide [EGOS-GEN-EDDS-CIG-1001]	Version 6.0, 2014-12-17
[RD-16]	Google Protocol Buffers [ <a href="https://developers.google.com/protocol-buffers/">https://developers.google.com/protocol-buffers/</a> ]	2012-09-17

## 3. Glossary

### 3.1 Acronyms

Acronyms	Description
AES	Advanced Encryption Standard
APID	Application Identifier
ASCII	American Standard Code for Information Interchange
CCSDS	Consultative Committee for Space Data Systems
CDR	Critical Design Review
CUC	CCSDS Unsegmented Code
DARC	Parameter Archive
DDID	Data Definition Interface Document
DVD	Digital Video Disc (Digital Versatile Disc)
EDDS	EGOS Data Dissemination System
ESA	European Space Agency
EGOS	ESA Ground Operations System
ERT	Earth Reception Time (Note: SCOS-2000 uses the SCOS-2000 reception time stamp and not the ground station reception time stamp.)
EV	Event (Mission control system event)
FARC	File Archive
GDDS	Generic Data Disposition System
HTTP	Hypertext Transfer Protocol
HTTPS	HTTP over Secure socket layer
JMS	Java Messaging Service
MAS	Mission Automation System
MCS	Mission Control System
MMI	Man Machine Interface
MUST	Mission Utility & Support Tool
OBEV	On-board Event
OBQ	On-board Queue
OBSM	On-board Software Maintenance
OBT	On-board Time
OOL	Out Of Limit
PARC	Packet Archive
PID	Process Identifier
PUS	Packet Utilisation Standard
SCOS	Spacecraft Control and Operations System
SMTP	Simple Mail Transfer Protocol
SOAP	<i>Originally</i> - Simple Object Access Protocol - <i>but since version 1.2 it has no official meaning</i>
SPID	SCOS-2000 Packet Identifier
SUM	Software Users Manual
TBD	To be decided
TBW	To be written
TC	Telecommand
TM	Telemetry
WSDL	Web Services Description Language
XFDU	XML Formatted Data Unit
XML	Extensible Mark-up Language
XSL	Extensible Stylesheet Language



Acronyms	Description
XSLT	XSL Transformations

### 3.2 Definition of Terms

Terms	Description
Batch Service	An EDDS service that allows a user or client application to make a request for mission data and receive a (single) response from the EDDS that contains the complete set of data requested.
Stream Service	An EDDS service that allows a client application to receive a continuous stream of mission data rather than a finite stored data set.
SCOS-2000	SCOS-2000 is a generic configurable spacecraft control and monitoring system with multi-domain and multi-mission capabilities, which operates in a scalable distributed environment. It is intended to be taken by client missions and customised to meet their specific requirements. At the time of writing this document SCOS-2000 release 5 is expected to be the baseline.
Web Services	Web services provide a standard means of interoperating between different software applications, running on a variety of platforms and/or frameworks. Web services are characterized by their great interoperability and extensibility, as well as their machine-processable descriptions thanks to the use of XML. They can be combined in a loosely coupled way in order to achieve complex operations. Programs providing simple services can interact with each other in order to deliver sophisticated added-value services. [ quoted from W3C Web services Activity Statement - <a href="http://www.w3.org/2002/ws/Activity">http://www.w3.org/2002/ws/Activity</a> ]
SCOS-2000 Domain	The controlled or controlling entity whose packet data is stored in a dedicated SCOS-2000 multi-domain archive. For example, a spacecraft or a ground station or a controlling domain such as System Control. Each individual spacecraft will be mapped to a specific domain. Each domain will have its own instance of SCOS-2000. Taken from [RD-10].
SCOS-2000 Packet Identifier (SPID)	The identifier of the history file containing all instances of a SCOS-2000 packet. This is unique for each packet type (TM, TC and EV). In the telemetry processing, the SPID is also used as the unique identifier of the packet content for fixed packets. Taken from [RD10].
SCOS-2000 DataStream	A logical grouping of SCOS-2000 history files used to partition the historical data and to enable the selective retrieval and processing of them. Also refers to a stream of telemetry transfer frame data received by the SCOS-2000 Packetiser. Taken from [RD10].
SCET	Used in this document to indicate the value of the counter from the spacecraft's onboard clock (i.e. an integer value).
Onboard Time (OBT)	Used in this document to mean the UTC correlated onboard time corresponding to SCET. It should be noted that duplicate packets with the same SCET can have a different OBT if they are time-stamped using a different time-correlation.

## 4. Software Overview

The primary purpose of the EDDS is to provide controlled access to mission data for users who do not have access to the mission control system (MCS) monitoring and control facilities. The data includes science and non-science telemetry data, telecommand data, and auxiliary data such as flight dynamics data.

The EDDS offers data services and management services. A user interface is provided to these services through the EDDS Client Application see [RD-1]. This document (EUICD) describes the interfaces available to users and client applications. These external interfaces provide access to the EDDS data services:

- Authentication Services
- Batch Service
- Stream Service
- User Management Service

### 4.1 EDDS Services Overview

#### 4.1.1 Authentication Services

The EDDS User Management Service allows a client application to make request for the log in and log out of the users from the EDDS. It also allows for a sufficiently privileged user to update the LDAP details held on themselves or others.

#### 4.1.2 Batch Service

The batch service is intended to allow clients to make requests for mission data and receive a data response that contains a complete set of data that matches the request. In general, a request lists the data types and allows the user to apply a set of filters for each data type. The response data is sent to the client via the delivery method indicated in the request. A batch service request can be viewed as transient in the sense that the EDDS processes the request, builds the data set (by retrieving the relevant data) and then delivers the data set to the user. The request is then considered complete.

A batch request is submitted as an XML document. The data response can take one of these forms:

- A binary or ASCII file (can also be compressed or encrypted);
- An XML file displayed on the MMI.

The format of response content depends on the type of requests as described in Section 6

Each request always has associated acknowledgement data. The acknowledgement data can be return to the user on explicit user request. The acknowledgement data indicates the status of the request and gives details for failures. Acknowledgement data is received as an e-mail or can be downloaded as an XML document.

The Batch request response files can be compressed. The compressed files can be one of a number of file archive formats that are supported by the EDDS. By default, compression is applied to the data. Currently the supported compressed file types are:

- zip – ZIP;
- tar - USTAR format (uncompressed);
- tar.gz - USTAR format compressed with gzip.

On top to the data compression, the EDDS allows to encrypt the data according to the AES algorithm, which is enabled or disabled at mission level.

### 4.1.3 Stream Service

An EDDS stream service allows a client application to receive a continuous stream of mission data rather than a finite stored data set. A client application makes a request for the stream service to the EDDS and then actively requests the streamed data from the EDDS.

A stream request is submitted as an XML document. The data response can be obtained either directly from the ActiveMQ topic or via the client API via CometD. The EDDS MMI uses the client API. Each message on the topic represents one packet or parameter, each associated with the original request by the request ID header field on the message. Currently only streaming of parameters from the DARC is supported.

The payload of each message contains a framed byte array, which represents an encoded parameter using Google Protocol Buffers. The payload can be decoded using the provided helper classes found in the `esa.egos.edds.types` package. For DARC Parameters, the `DarcParamRec` class can be used. The proto files describing the data structure are stored in `edds-ws-common` and are compiled as a part of the build process.

#### 4.1.3.1 DARC Streaming Support

Receiving streamed data from the DARC only works with compatible versions of DARC for SLES 11 (version 2.1.1 or later). EDDS expects the DARC to put parameter samples onto an ActiveMQ topic owned by the DARC with the following header data:

Header Field	Type	Description
ValueType	String	The type of the value field – one of BOOLEAN, INTEGER, STRING, DOUBLE, FLOAT, LONG
Value	Variable	Value of the parameter sample. Type can be either Boolean, Short, Integer, String, Double, Float. For Short values, the ValueType should be set to INTEGER.
Validity	Integer	One of 0 (Valid), 1 (Invalid), 2 (Unknown), 3 (Expired)
SystemElement	String	Any String value
Source	String	Any String value
State	Short	Any Short value
GenericData	String	Any String value
GenerationTime	Double	Unix time stamp of the generation time
Name	String	Name of the parameter

When a user requests live parameter samples from the DARC, EDDS will add a listener to this topic with a selector on these header fields based on the filter specified in the request. This improves performance, as only matching messages are delivered by the broker to EDDS for processing. EDDS then creates a new message with two header fields, "RequestId" (with the user's original request ID) and "MISSION\_NAME" for the mission the stream relates to. It then creates a Google Protocol Buffers encoded record (See Appendix N) with the data from the header fields of the original message and adds it to the payload of a new message. These messages are received by the web server (or a 3<sup>rd</sup> party application – as they are placed on a topic, this doesn't interfere with the web server) and passed on to any listening clients via CometD.

### 4.1.4 User Management Service

An EDDS User Management Service allows a client application to make request for the management of the users, which have access to the EDDS services. Only authorised users can access the User Management services.

A user management request is submitted as an XML document.

## 4.2 EDDS Interface Overview

The following section describes the interfaces to the EDDS services.

### 4.2.1 EDDS Web Service Interface

Provides the set of operations that can be used by client applications to inject batch requests, user management requests and receive responses. The interface uses Web Services technology [RD-3][RD-7].

### 4.2.2 Stream Web Service Interface

Provides a set of operations that can be used by client applications to make stream requests and receive data in response. The interface uses Web Services technology [RD-3][RD-7].

### 4.2.3 Email Interface

Used by the EDDS components to deliver acknowledgement data to the user.

### 4.2.4 Delivery Manager Interface

The Delivery Manager is used by the EDDS to delivery batch data responses to a client hosted file server.

## 4.3 Client Applications Overview

A user can interact with the EDDS by use of several client application types:

- EDDS Client Application (via generic APIs)
- Web Services Application
- Email Server
- Delivery Manager
- Request Submitter

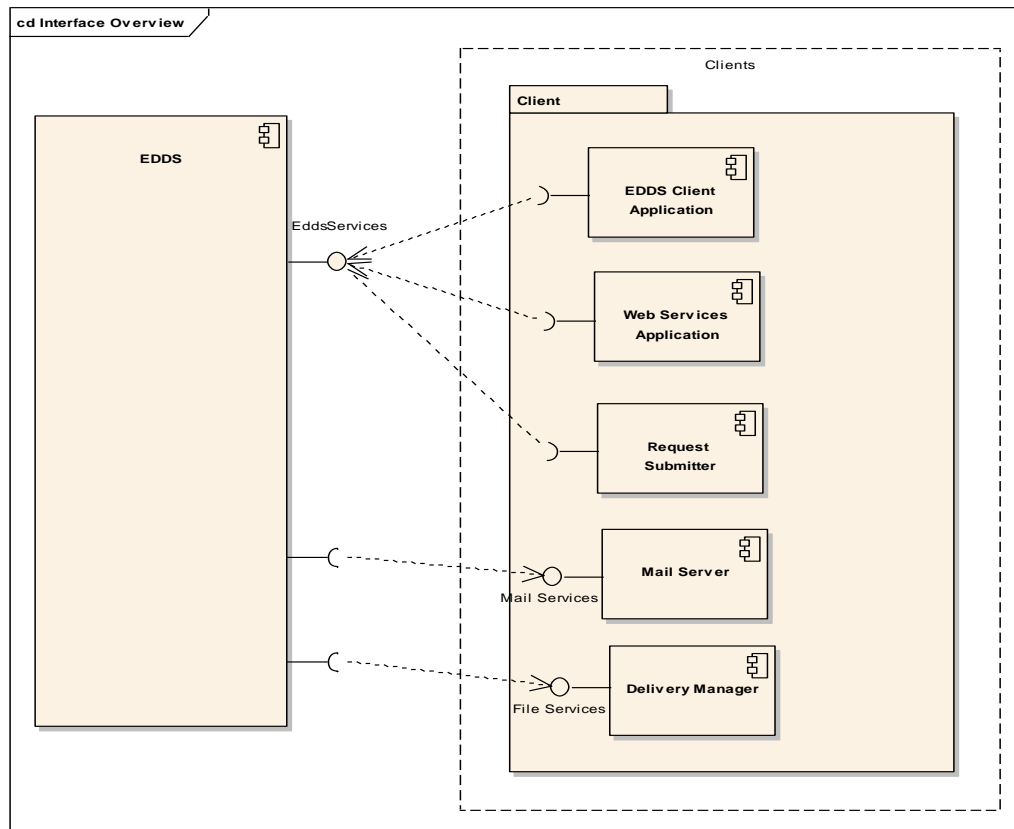

Figure 1 - Interface Overview

### 4.3.1 EDDS Client Application

The user interface to the EDDS is the EDDS Client Application. This application is downloaded from the EDDS web site and is run on the user's machine. See the EDDS Client SUM [RD-1] for more information on installation configuration and usage.

The EDDS Client provides GUI access to all available EDDS services (management and batch and streaming services). This document (EUICD) describes the format of the data that is sent to the Web Services Application.

The EDDS provides access to its management batch and stream services through Web Services technology. Users can write their own client applications that access EDDS batch and stream services through the use of Web Services technology.

### 4.3.2 Email Server

EDDS is capable of delivering batch service acknowledgement messages to a client via email. This document (EUICD) describes the format of the acknowledgement message.

### 4.3.3 Delivery Manager

EDDS is capable of delivering batch service responses to a file server running on the client's site. This document (EUICD) describes the format of batch service requests and the format of the resultant response. This document (EUICD) also describes the format of acknowledgement messages.

### 4.3.4 Request Submitter

The EDDS Request Submitter is a lightweight standalone application that polls a configurable directory for request files. Any valid request files either in EDDS or GDDS format will be processed and submitted to the EDDS Server. Responses are returned as defined in the request.

All valid requests are submitted through the same user account specified in the RS configuration.

The EDDS request file must conform to the schema element RequestMessagePart as defined in [C.58]

#### 4.3.4.1 GDDS Requests

EDDS Request Submitter also accepts requests in GDDS format [RD-13]. All GDDS request types are supported, but there are additional restrictions, because GDDS requests and EDDS requests are not fully compatible. The GDDS request is transformed into EDDS request via XSL Transformation (XSLT) and submitted for processing via EDDS client API. The mapping of GDDS schema elements is described below.

The response data will be in EDDS format and delivered by EDDS.

XSL transformation can be also performed independently of Request Submitter. On SLES 11 run from the terminal:

```
xsltproc path/to/transformation.xsl path/to/gddsRequest.xml
```

For example, to transform one of the test requests and output it to the console, you can run from edds source directory:

```
xsltproc edds-request-submitter/src/main/resources/gdds/GDDS2EDDS.xsl edds-request-submitter/src/test/resources/GDDSRequests/PktTcReportRequest.xml
```

#### 4.3.4.1.1 Common request fields

Element in GDDS request	Is mapped to
userRequestId attribute in scheduleRequest and onlineRequest	Not used, but are added to the EDDS request comment
schedule/firstStartTime	If set, used as execution time of the first request
schedule/interval	Number of days between scheduled requests; GDDS request doesn't have end date in the schema, so 10 requests will always be created for

	scheduled requests
schedule/acknowledgement	Not used
general/comment	EDDS request comment field
general/userInfo/username and general/userInfo/FTPpassword, general/destInfo/FTP/target	Username and password are used as credentials for target FTP server if latter is provided; otherwise EDDS server delivery is used.
general/destInfo/RDM and subelements	Not used
general/destInfo/Online and subelements	Not used
general/destInfo/FTP/filename	Used as the target filename
general/destInfo/FTP/directory	Target directory, if file server delivery is used
general/formatInfo/compression	EDDS compression option
general/formatInfo/SFDUrequired	Not used
general/formatInfo/missionFormat	Not used
general/dataInfo/earliestStart	If set, the execution time of the (first) request; schedule/firstStartTime overrides this value
item	Exactly one item should be specified, contains the request type and filter elements. The filter tree must not contain any OR binary operation nodes inside AND nodes

#### 4.3.4.1.1 *Mission and Domain*

By default, the request is submitted to the default mission and domain as configured in the file poller settings. Different mission and domain can be used for the request by having extra lines in the GDDS comment field. Keyword Mission or Domain followed by a colon character, and then the EDDS mission or domain name.

Example:

```

...
  <general>
    <comment>
      Mission:TEST_MISSION
      Domain:0
      Example GDDS request comment
    </comment>
  ...

```

#### 4.3.4.1.2 *MultiTime elements*

All the Multitime elements (i.e. SourcePktsGenTime, ExecutionTime, UplinkTime) should be in absolute time format, not in duration. Except when scheduleRequest is sent, then the required boundaries must be set as duration – start time (lower boundary) as relative time from the execution and end time as the duration after start time. Other MultiTime elements should still be in absolute time.

Example:

The following GDDS request will create scheduled request that will execute 10 requests in 5 days intervals. The packet data is retrieved starting from 3 months before the execution time and ending 21 days after start time. Additional filter is applied with UplinkTime >= 2002-01-01T12:00:00Z.

The relevant fragments of the request:

```

<scheduleRequest xmlns:xsi="http://www.w3.org/2001/XMLSchema-instance"
xsi:noNamespaceSchemaLocation='GDDSScheduleRequest.xsd'
userRequestId="20020101GDDSScheduleRequestExample">
<schedule>
  <firstStartTime>2002-01-01T20:00:00Z</firstStartTime>
  <interval>5</interval>
  <acknowledgement>>true</acknowledgement>
</schedule>
<onlineRequest userRequestId="20020101GDDSScheduleRequestExample">
...
  <item>
    <dataType>CMH</dataType>
    <dataSource>CMDH</dataSource>
    <catalogueRequest>>false</catalogueRequest>
    <filter>
      <bin operation="OP_AND">
        <lhs>
          <leaf operation="OP_GTE">
            <valuePair>
              <ExecutionTime>
                <a_duration>-P3M</a_duration>
              </ExecutionTime>
            </valuePair>
          </leaf>
        </lhs>
        <rhs>
          <bin operation="OP_AND">
            <lhs>
              <leaf operation="OP_GTE">
                <valuePair>
                  <UplinkTime>
                    <a_dateTime>2002-01-01T12:00:00Z</a_dateTime>
                  </UplinkTime>
                </valuePair>
              </leaf>
            </lhs>
            <rhs>
              <leaf operation="OP_LTE">
                <valuePair>
                  <ExecutionTime>
                    <a_duration>P21D</a_duration>
                  </ExecutionTime>
                </valuePair>
              </leaf>
            </rhs>
          </bin>
        </rhs>
      </bin>
    </filter>
  </item>
</onlineRequest>
</scheduleRequest>

```

#### 4.3.4.1.1.3 Filter expressions

Filter expressions should be simple: there should be no OR operations inside AND operations. So all the OR expressions should be towards the filter root. If there are any of those "illegal" expressions, the whole subtree will be ignored.

Example:

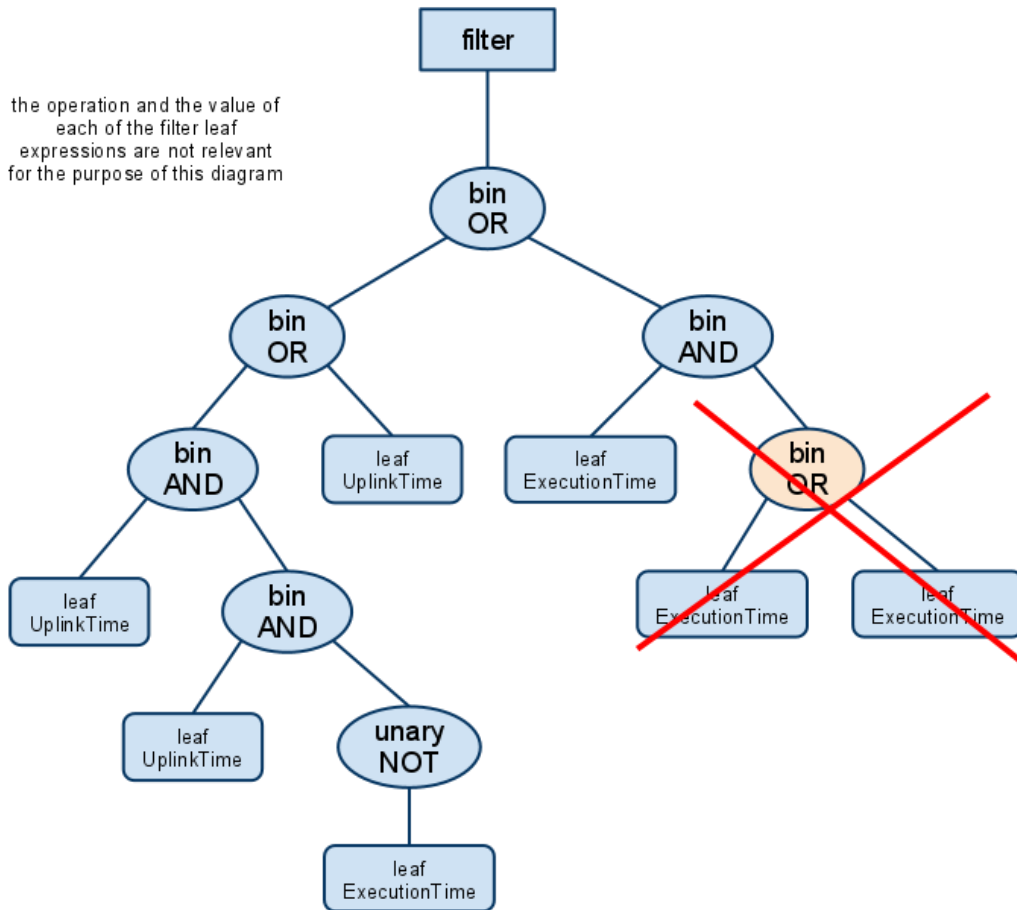

**4.3.4.1.2 TM Packet request**

This section describes the types of data request available in GDDS and how they map to the EDDS schema (where possible to map)

Item subelements	Description
dataType='TLM'	Determines the TM packet request type
dataSource	Filter packets by this Apid value
catalogueRequest	Not used
keyword	Not used
onEvent	Not used
filter	Required. Must contain a leaf element with operation OP_GTE or OP_GT and with keyword SourcePktsGenTime and another one with operation OP_LTE or OP_LT. These will be the lower and upper bound of the timerange for the query.

Supported keywords in filter are

Filter keyword	Mapped to	Allowed operations
SourcePktsGenTime and S2KpktsGenTime	GenerationTime	All operations
VolumeSize	MaxVolumeSize	All operations
Type, SubType, P1Val, P2Val		OP_EQ and negation in unary node with OP_NOT. One



		keyword can only appear once in a conjunctive clause (leaves separated with only AND expressions).
--	--	--

#### 4.3.4.1.3 TC Packet History

Item subelements	Description
dataType='CMH'	Determines the TC packet request type
dataSource='CMDH'	Determines the raw TC packet request type
catalogueRequest	Not used
keyword	Not used
onEvent	Not used
filter	Required. Must contain a leaf element with operation OP_GTE or OP_GT and with keyword ExecutionTime and another one with operation OP_LTE or OP_LT. These will be the lower and upper bound of the timerange for the query.

Supported keywords in filter are

Filter keyword	Mapped to	Allowed operations
ExecutionTime	ExecutionTime	All operations
UplinkTime	UplinkTime	All operations
VolumeSize	MaxVolumeSize	All operations

#### 4.3.4.1.4 TC Packet brief and full report

Item subelements	Description
dataType='CMH'	Determines the TC packet request type
dataSource='CMDPB' or dataSource='CMDPF'	Whether we want to get the brief report ('CMDPB') or full report with command parameters ('CMDPF').
catalogueRequest	Not used
keyword	Not used
onEvent	Not used
filter	Required. Must contain a leaf element with keyword ExecutionTime and with operation OP_GTE or OP_GT and another one with operation OP_LTE or OP_LT. These will be the lower and upper bound of the timerange for the query.

Supported keywords in filter are

Filter keyword	Mapped to	Allowed operations
ExecutionTime	ExecutionTime	All operations
UplinkTime	UplinkTime	All operations

VolumeSize	MaxVolumeSize	All operations
------------	---------------	----------------

#### 4.3.4.1.5 ArchiveFile request

Item subelements	Description
dataType='AUX'	Determines the request type
dataSource	Not used
catalogueRequest	Not used
keyword	Not used
onEvent	Not used
filter	Required.

Supported keywords in filter are

Filter keyword	Mapped to	Allowed operations
Name	Name	OP_EQ
Release, Issue	Version (Release and Issue are concatenated with a dot '.' character)	OP_EQ
CreationTime	CreationTime	Not supported
TimeSpan	ValidityTime	Not supported

## 5. Data Types

This section outlines a user's perspective of the data types that the EDDS supports. Table 1 (below) gives an overview of the data types and the services which provide the data type.

<b>Delivery</b> <b>Data Type</b>		<b>File Server</b>	<b>EDDS Server</b>	<b>Stream</b>		<b>Email</b>
				<b>Online</b>	<b>Offline</b>	
<i>Packet</i>	<i>TM (EDDS Raw)</i>	✓	✓	✓	✓	-
	<i>TM (PARC Raw)</i>	✓	✓	✓	✓	-
	<i>TC (EDDS Raw)</i>	✓	✓	✓	✓	-
	<i>TC (PARC Raw)</i>	✓	✓	✓	✓	-
	<i>EV (EDDS Raw)</i>	✓	✓	✓	✓	-
	<i>EV (PARC Raw)</i>	✓	✓	✓	✓	-
	<i>Statistics</i>	✓	✓	-	-	-
<i>Parameter</i>	<i>TM</i>	✓	✓	✓	✓	-
	<i>Statistics</i>	✓	✓	-	-	-
	<i>Preview</i>	✓	✓	-	-	-
	<i>Definition</i>	✓	✓	-	-	-
<i>Report</i>	<i>MCS</i>	✓	✓	-	-	-
	<i>EDDS</i>	✓	✓	-	-	-
<i>Archived Files</i>	<i>File</i>	✓	✓	-	-	-
	<i>Catalogue</i>	✓	✓	-	-	-
<i>File System</i>	<i>File Catalogue</i>	✓	✓	-	-	-
	<i>Folder Catalogue</i>	✓	✓	-	-	-
	<i>File</i>	✓	✓	-	-	-
<i>Acknowledgement</i>		✓	✓	-	-	✓

Table 1 - Data Type & Service Overview

### 5.1 Packet

Packet data provided by the EDDS consists of telemetry (TM), telecommand (TC) and MCS event (EV) packets. The packets contain binary data as processed by the MCS in Network endian order. In addition packet statistics data is available that provides statistical information about packets stored in the MCS (e.g. the number of packets that match a given criterion for a given time span). Packets are extracted by using the PARC Manager interface of a dedicated packet archive (PARC). The TM/TC/EV Raw format retrieves the packet data from the PARC exactly as it is stored as a hexadecimal string, and wraps each packet in an XML tag so that they can be identified. The data is not decoded, and so cannot be filtered beyond the basics of start time, end time and (for TM and EV) SPID list.

Packet statistics data are available that provides statistical information about stored packets. Packet Reports are available that decode the encoded packet data and store the data in an XML or ASCII formatted file.

## 5.2 *Parameter*

TM parameter data can be obtained through EDDS services. Parameter data is available from a dedicated parameter archive (DARC or SMON).

The parameter archive is populated as TM source packets are received by the MCS and is tailored to provide fast access to the parameter data stored. Due to the large number of TM parameters defined for a mission and their associated data, it may be impractical to store all parameters in a dedicated parameter archive. The mission will be able to configure which subset of parameters is stored in the dedicated parameter archive.

The ordering of parameter samples is not guaranteed (although usually the data is ordered by sample generation time). EDDS tries to use optimal retrieval mechanisms based on the API provided by backend and does not provide any ordering on its own.

Duplicate entries might exist in special cases where request for all DARC parameter samples is being resumed (after an explicit client request to suspend/resume or after EDDS server has been stopped/killed before processing of the request was finished). To avoid duplicates, split size of the result files can be set to 0, so the entire request will be restarted from the beginning.

Parameter statistics data is available that provides statistical information about stored parameters (e.g. the number of parameters that match a given criterion for a given time span).

Parameter Definition data type is used to provide parameter static definition data (e.g. description, unit, subsystem, etc) which is derived from the spacecraft database.

## 5.3 *Report*

This data type covers both reports generated by the MCS and those generated by the EDDS. A report is always in XML, ASCII, Binary or spreadsheet format.

MCS reports can be classified into TM, TC, EV and other reports. The availability of such reports is mission dependent and includes:

- TM Packet Report
- TM Packet Gap Report
- TC Packet Report
- OOL Data Report
- Event Record Report

EDDS reports are generated by the EDDS on user request. They are:

- Status Reports (not currently supported in this version)
- Request Summary Reports (not currently supported in this version)
- System Log Reports
- EDDS Usage Report

The content of EDDS reports is given in Section 6.2.3

Reports supported by the EDDS will be in XML format, with missions providing XSLT for transforming the reports into their final delivery format. This also allows missions to specialise reports with full EDDS support.

## 5.4 *Archived Files*

The Archived Files data type contains files stored in the MCS archive including files received from Flight Dynamics, Mission Planning and TT&C stations. Additionally catalogue information is also available in XML format. The file data and catalogue are retrieved from the FARC. For FARC versions that support it,

it is possible to register interest in items in the FARC so that when they change, a notification is received by EDDS. EDDS will then automatically retrieve the requested file from the FARC.

## 5.5 Acknowledgement

Acknowledgement data is data generated by EDDS and sent/taken to the user on request. Acknowledgement data contains status information. Acknowledgement data are produced by the EDDS at the different stages of the request processing and execution when the request for data is received by the EDDS or when the request has been completed successfully.

## 5.6 Request and Response Mappings

The table below maps the XML responses to each request so that the expected XML response types can be determined based on the request submitted. Note that not all requests will result in an XML file being returned.

Request type (BatchRequest/DataRequest)	Response type (ResponsePart/Response)
Param	ParamResponse C.38
SMONParam	SMONParamResponse C.66
ParamStatistics	ParamStatisticsResponse C.44
ParamDefinition	ParamDefinitionResponse C.29
ParamPreview	ParamPreviewResponse C.35
PktEv	N/A – binary response format
PktTm	N/A – binary response format
PktTc	N/A – binary response format
PktEvRaw	PktRawResponse C.48
PktTmRaw	PktRawResponse C.48
PktTcRaw	PktRawResponse C.48
PktTmStatistics	PacketStatisticsResponse C.23
PktTcStatistics	PacketStatisticsResponse C.23
PktEvStatistics	PacketStatisticsResponse C.23
PktTmReport	PktTmReportResponse I.24
PktTmGapReport	PktTmGapReportResponse I.27
PktTcReport	PktTcReportResponse I.20
EventRecordReport	EventRecordReportResponse I.9
ArchiveCatalogue	CatalogueResponse C.11
ArchiveFile	N/A – binary response format
ArchiveSubscription	N/A – binary response format
OolRecordReport	OolDataReportResponse I.11
EddsUsageReport	EddsUsageReportResponse I.5
FileSystemFileCatalogue	FileSystemFileCatalogueResponse F.7
FileSystemFolderCatalogue	FileSystemFolderCatalogueResponse F.10
FileSystemFile	N/A – binary response format
FileSystemFileSubscription	N/A – binary response format

Table 2 – Request and Response Mappings

## 6. Formats

The following section describes the formatting of data. The EDDS supports following formats:

- Binary
- EDDS Binary
- XML (and XML Transform)
- SFDU [AD-2]
- ASCII

Different data types support various formatting. Table 3 provides a summary of the possible formats that are supported by each request type.

<b>Request Type</b>		<b>Format</b>	<b>EDDS Binary</b>	<b>Binary</b>	<b>SFDU</b>	<b>XML (XML Transform)</b>	<b>ASCII</b>	<b>Others</b>
<i>Packet (From PARC)</i>	<i>TM</i>		√*		✓			GDDS_BINARY*
	<i>TM (PARC Raw)</i>			√*		√*		
	<i>TM Report</i>			√*		√*	√*	
	<i>TM Gap Report</i>			✓		✓		
	<i>TM Statistics</i>					✓		
	<i>TC</i>		√*		✓			GDDS_BINARY*
	<i>TC (PARC Raw)</i>			√*		√*		
	<i>TC Report</i>			√*		√*	√*	
	<i>TC Statistics</i>					✓		
	<i>EV</i>		√*					
	<i>EV (PARC Raw)</i>			√*		√*		
	<i>Event Record Report</i>			√*		√*	√*	
	<i>EV Statistics</i>					✓		
	<i>OOL Record</i>					√*	√*	
	<i>Parameter (from SMON)</i>	<i>TM</i>			√*		√*	
<i>Parameter (From DARC)</i>	<i>TM</i>			√*		√*		TDRS
	<i>Statistics</i>					√*	√*	
	<i>Preview</i>					√*	√*	
	<i>Definition</i>			√*		√*		
<i>Report (From EDDS)</i>	<i>EddsUsage</i>					✓		
<i>Archived Files (From FARC)</i>	<i>File (and File Subscription)</i>			✓				
	<i>Catalogue</i>					✓	✓	
<i>File System</i>	<i>File Catalogue</i>					✓	✓	
	<i>Folder Catalogue</i>					✓	✓	
	<i>File (and Subscription)</i>			✓				
<i>Acknowledgement</i>						✓		

Table 3 - Data Type Formatting

The formats marked with \* support splitting the response files into smaller chunks. The resulting files are still compliant with the format with appropriate header and tail in the files. To enable splitting, the configuration must be done by EDDS admin.

The following sections detail the formats and the applicable data types.

## 6.1 EDDS Binary

The format for EDDS raw data is both self-describing and extensible, and allows a mission to choose which of the standard EDDS header fields are included in that file. For a response consisting of  $N$  elements, the basic structure is as follows:

EDDS Raw Header
EDDS Header Fields (1)
Data Element (1)
EDDS Header Fields (2)
Data Element (2)
...
EDDS Header Fields ( $N$ )
Data Element ( $N$ )

Table 4 - Structure of EDDS Binary Data

The response data consists of a single EDDS Raw Header (based on what has been selected as the header fields), followed by the data element (this is the case both when the data is stored in a raw (ASCII hexadecimal) file, and when raw data is returned via a streaming service). Each data element is preceded by the EDDS header fields.

### 6.1.1 EDDS Raw Header

The EDDS Raw Header is a variable-size header, which serves the following purpose:

- Allows a user to uniquely identify binary data as being EDDS binary data
- Allows a user to find out which header fields are present in the binary data

The format of the EDDS binary header is as follows:

Field	Size (octets)	Type	Description
N	1	Integer	Total number of header fields defined for this data type. This is the total number of EDDS header fields (can be zero)
Size_1	1	Integer	Number of octets used for Header Field 1
Size_2	1	Integer	Number of octets used for Header Field 2
...	...	...	...
Size_ $N$	1	Integer	Number of octets used for Header Field $N$

Table 5 - Format of the EDDS File Header

If should be underlined that in case one of the fields is a string the Size field of the header will not represent its length (since the size of a string is known only at run time) but will indicate if the field has to be included or not in the generated file.

The actual header fields, which can be present in EDDS binary data, depend on the data type; these will be defined in the following sections of this document.

Note: this section will contain the value "00" if the values of size1, size2, ..., size  $N$  (defined in the EDDS File Header) are all zero.



## 6.1.2 Packet Data

The packet data depends on the data type. This will be defined in the following sections for each data type. The Appendix "Packet Data" in the Configuration and Installation Guide (CIG) [RD-15] contains detailed instruction on the implementation of the header structures for the information files.

### 6.1.2.1 TM

The EDDS defines the following fields, which can be included in the header for TM packet data (see section 6.1.1 ):

Number	Field	Type	Description
1	Source Sequence Counter	Unsigned Integer	The sequential binary count of each source packet generated by an application process identified by a unique application process identifier.
2	APID	Unsigned Integer	The PUS Service Application Process Identifier, uniquely identifies the on board source of the packet.
3	PID	Unsigned Integer	The Packet ID, calculated from the APID
4	Category	Unsigned Integer	The Packet Category, calculated from the APID
5	P1val	Unsigned Integer	SCOS-2000 P1 Value (the meaning is mission-specific)
6	P2val	Unsigned Integer	SCOS-2000 P2 Value (the meaning is mission-specific)
7	Data Stream	Unsigned Integer	SCOS-2000 Data Stream
8	Generation Time	CCSDS CUC	Time-correlated On-Board Generation Time
9	Reception Time	CCSDS CUC	Time at which the TM packet was extracted from its Transfer Frame on-ground
10	Packet Length	Unsigned Integer	Length of the packet. Added for backward compatibility with the GDDS
11	SPID	Unsigned Integer	SCOS-2000 Packet ID
12	Ground Station	Unsigned Integer	Id of the ground station which downlinked this telemetry packet
13	Virtual Channel	Unsigned Integer	Virtual Channel number of the on-board data source.
14	Data Unit type	Unsigned Integer	Identifies the data unit type
15	Type	Unsigned Integer	PUS Service Type
16	Subtype	Unsigned Integer	PUS Service Subtype
17	SleServiceID	Unsigned Integer	An 8-bit integer value that defines the SLE service used. Added for backward compatibility with the GDDS
18	Time Quality	Unsigned Integer	The value of the time quality flag 0 = GOOD, 1 = INACCURATE, 2 = BAD.

Number	Field	Type	Description
19	Quality Flag / Time Stamp Type	Unsigned Integer	Indicates the data quality of the TM packet 0 = Packet Reception (PR), 1 = Frame Transmission (FT), 2 = Packet Generation (PG)
20	Database Version	Unsigned Integer	Version of the SCOS-2000 database used to extract this packet from its transfer frame
21	Domain	Unsigned Integer	The SCOS-2000 domain in which this TM packet was generated

Table 6 - TM Packet Raw Header Fields

Note: while the data in some of these header fields may be contained in the raw TM packet data itself, these header fields are still defined by EDDS for the convenience of missions which wish to include this information also in the EDDS header for each TM packet.

For a specific telemetry packet data file, the EDDS file header determines which fields are included in that file, and the corresponding field lengths.

Note any string field will be translated in the packet as follow:

<string length in hexadecimal >+<string represented in hexadecimal >

In the case of the TM packet data type, the data field itself consists of the raw packet as generated by the spacecraft but preceded by an EDDS sequence counter and the packet length:

Field	Content	Size	Description
Count	EDDS Sequence Count	1 byte	Data element sequence count applied by EDDS. Client applications can use this to detect missing data. Note that the counter is reset to 0 once 255 is reached. If suspending and resuming a request, the counter is reset on resume. The counter continues when the file is split.
Length	Data Length	4 bytes	Size of the Data field in octets
Data	TM packet	Raw	Raw packet in network endian order

Table 7 - TM Packet Raw Data Element

### 6.1.2.2 TC

The EDDS defines the following fields, which may be included in the header for TC packet data (see section 6.1.1):

Number	Field	Type	Description
1	Type	Unsigned Integer	PUS Service Type
2	Source Type	Byte	Type of originating command source
3	Subtype	Unsigned Integer	PUS Service Subtype
4	APID	Unsigned Integer	Application Process Identifier
5	PID	Unsigned Integer	Packet ID, calculated from the APID

Number	Field	Type	Description
6	Category	Unsigned Integer	Packet Category, calculated from the APID
7	Virtual Channel	Unsigned Integer	The Virtual Channel ID
8	Verification Status	Unsigned Integer	Verification Status. This corresponds to the Command Verification Stages defined in field 13. (The meaning of the verification status is mission-specific.)
9	Uplink Time	CCSDS CUC	Time of command uplink (if any)
10	Execution Time	CCSDS CUC	Predicted/actual time of command execution
11	Last Update Time	CCSDS CUC	Time the command was last updated
12	Release Time	CCSDS CUC	Time the command was released
13	Sequence Name	String	Name of the top-level parent sequence to which this instance of the command belongs (if any)
14	Subschedule	Unsigned Integer	On-board Sub Schedule to which this command belongs
15	Subsystem	String	Associated Sub-system
16	Command Source	String	The name of the workstation used to release the telecommand
17	Command Acknowledgement	Unsigned Integer	Four-bit representation of the Service 1 report packets to be generated by the spacecraft
18	Command Verification Stages	String	The verification stages of the telecommand as supported by infrastructure (R, GTO or AC).
19	Data Stream	Unsigned Integer	SCOS-2000 Data Stream
20	Domain	Unsigned Integer	SCOS-2000 Domain
21	Database Version	String	Version of the SCOS-2000 database used to encode this telecommand
22	PUS Source Sequence Count	Unsigned Integer	PUS Source Sequence Counter
23	CUV	Unsigned Integer	Command UV Onboard verification stage
24	CAV VC0	Unsigned Integer	Command EV Acceptance verification stage
25	CEV VC0	Unsigned Integer	Command EV Execution start verification stage
26	CAV VC1	Unsigned Integer	Command EV Acceptance verification stage
27	CEV VC1	Unsigned Integer	Command EV Execution start verification stage
28	Packet Length	Unsigned Integer	Size of the packet
29	Command Name	String	The name of the command

Table 8 - Possible TC Packet Raw Header Fields

Note: while the data in some of these header fields may be contained in the raw TC packet data itself, these header fields are still defined by EDDS for the convenience of missions which wish to include this information also in the EDDS header for each TC packet.

For a specific telecommand packet data file, the EDDS file header determines which fields are included in that file, and the corresponding field widths.

Note any string field will be translated in the packet as follow:

<string length in hexadecimal >+<string represented in hexadecimal >

In the case of the TC packet data type, the data field itself consists of the raw telecommand packet sent to the spacecraft:

Field	Content	Size	Description
Count	EDDS Sequence Count	Unsigned Integer	Data element sequence count applied by EDDS. Client applications can use this to detect missing data.
Length	Data Length	Unsigned Integer	Size of the Data field in octets
Data	TC packet	Raw	Raw packet in network endian order

Table 9 - TC Packet raw Data Element

### 6.1.2.3 EV

EDDS defines the following fields, which can be included in the header for SCOS-2000 EV packet data (see section 6.1.1 ):

Number	Field	Type	Description
1	Event Type	String	Type of the event
2	Event Id	String	Event Id
3	Source	String	The source of the event
4	Category	String	Category of the event
5	Generation Time	CCSDS CUC	Generation time of the event
6	Domain	Unsigned Integer	SCOS-2000 domain

Table 10 - Possible EV Packet Raw Header Fields

For a specific event packet data file, the EDDS file header determines which fields are included in that file, and the corresponding field widths.

Note any string field will be translated in the packet as follow:

<string length in hexadecimal >+<string represented in hexadecimal >

In the case of the EV packet data type, the data field itself consists of the raw SCOS-2000 event packet:

Field	Content	Size	Description
Count	EDDS Sequence Count	Unsigned Integer	Data element sequence count applied by EDDS. Client applications can use this to detect missing

			data.
Length	Data Length	Unsigned Integer	Size of the Data field in octets
Data	EV packet	Raw	Raw SCOS-2000 event packet data

Table 11 - EV Packet Raw Data Element

### 6.1.3 GDDS Binary File Example

#### 6.1.3.1 TM Example

This section contains an example which shows how a GDDS TM packet binary data file would be represented using the EDDS binary file structure. The structure is based on the information contained in the GDDS ICD [RD-13]. The example provided assumes two TM packets (data elements) are present in the EDDS TM packet binary file.

GDDS telemetry packet header records contain the following fields:

- SCET (8 octets)
- Packet length (4 octets)
- Ground station ID (2 octets)
- Virtual Channel ID (2 octets)
- SLE Service (1 octet)
- Time Quality (1 octet)

These correspond to the following header EDDS header fields:

- Field 8 (Generation Time)
- Field 10 (Packet Length)
- Field 12 (Ground Station ID.)
- Field 13 (Virtual Channel)
- Field 17 (SLE Service ID)
- Field 18 (Time Quality Flag)

The following table illustrates the sequence and contents of each of the sections of the EDDS TM Packet binary file (the values are given in Hexadecimal. Note that two hexadecimal characters represent one octet):

Packet Header Fields (packet 1)	Field_1 (Generation Time)	4E94 46BE A7B8 D000
	Field_2 (Packet Length)	0000 0050
	Field_3 (Ground Station ID.)	0000
	Field_4 (Virtual Channel)	0000
	Field_5 (SLE Service ID)	00
	Field_6 (Time Quality Flag)	00

Packet Data (packet 1)	TM packet	0000 0000 FFFF FFFF 0000 C800 0100 C8C8 0000 0012 5800 0000 2100 0000 1BB5 A0A6 42AF 0400 0000 0000 0000 0000 0000 0000 5000 0000 0000 0000 5900 0000 B0E9 9B08 E0B4 9208 FFFF FFFF 5550 4441 5445 2025
Packet Header Fields (packet 2)	Field_1 (Generation Time)	4E94 46BE 6334 3000
	Field_2 (Packet Length)	0000 0050
	Field_3 (Ground Station ID.)	0000
	Field_4 (Virtual Channel)	0000
	Field_5 (SLE Service ID)	00
	Field_6 (Time Quality Flag)	00
Packet Data (packet 2)	TM packet	0000 0000 FFFF FFFF 0000 C800 0200 C8C8 0000 0012 5800 0000 2100 0000 1B51 D154 B6AF 0400 0000 0000 0000 0000 0000 0000 5000 0000 0000 0000 5900 0000 0000 0000 4E94 5872 0006 BF8B 4E94 5872 0006 BF8B

Table 12 - Example TM Packet Binary Format

Note that the generation time is in two parts. The first part (octets 0-3) is the number of seconds since epoch (1<sup>st</sup> Jan 1970) and the second part (octets 4-7) is the number of microseconds.

### 6.1.3.2 TC Example

This section contains an example which shows how a GDDS TC packet binary data file would be represented using the EDDS binary file structure. The structure is based on the information contained in the GDDS ICD [RD-13]. The example provided assumes two TC packets (data elements) are present in the EDDS TC packet binary file.

GDDS telecommand packet header records contain the following fields:

- Uplink Time (8 octets)
- Execution Time (8 octets)
- Command Uplink Stage CUV (2 octets)
- Command Acceptance Stage Real-Time CAV (VC0) (2 octets)
- Command Execution Stage Real-Time CEV (VC0) (2 octets)
- Command Acceptance Stage Playback CAV (VC1) (2 octets)
- Command Execution Stage Playback CEV (VC1) (2 octets)
- Packet Length of the DDS telecommand packet body (4 octets)
- Command ID (8 octets)
- Parent Sequence ID (8 octets)

These correspond to the following header EDDS header fields:

- Field 9 (Uplink Time)
- Field 10 (Execution Time)
- Field 23 (CUV)
- Field 24 (CAV VC0)
- Field 25 (CEV VC0)
- Field 26 (CAV VC1)
- Field 27 (CEV VC1)
- Field 28 (Packet Length)
- Field 29 (Command Name)
- Field 13 (Sequence Name)

The following table illustrates the sequence and contents of each of the sections of the EDDS TC Packet binary file (the values are given in Hexadecimal. Note that two hexadecimal characters represent one octet):

Packet Header Fields (packet 1)	Field 6 (Uplink Time)	4FB6 5AD2 000E 9A94
	Field 7 (Execution Time)	4FB6 5BE4 0006 9398
	Field 22 (CUV)	0004
	Field 23 (CAV VC0)	1000
	Field 24 (CEV VC0)	0000
	Field 25 (CAV VC1)	1000
	Field 26 (CEV VC1)	0000
	Field 27 (Packet Length)	0000 000D
	Field 28 (Command Name)	5A41 4330 3330 3036
	Field 10 (Sequence Name)	0000 0000 0000 0000
Packet Data (packet 1)	TC packet	18BC C1F1 0006 1903 0600 0084 C0
Packet Header Fields (packet 2)	Field 6 (Uplink Time)	4FB6 5AD2 000E 9A95
	Field 7 (Execution Time)	4FB6 5AD2 000E 9A95
	Field 22 (CUV)	0004
	Field 23 (CAV VC0)	0020
	Field 24 (CEV VC0)	0000
	Field 25 (CAV VC1)	0020
	Field 26 (CEV VC1)	0000
	Field 27 (Packet Length)	0000 0021
	Field 28 (Command Name)	5A4D 5431 3130 3034
	Field 10 (Sequence Name)	0000 0000 0000 0000
Packet Data (packet 2)	TC packet	18FC C012 001A 190B 0400 0007 4FB6 5BE4 6E56 18BC C1F1 0006 1903 0600 0084 C0B5 39

Table 13 - Example TC Packet Binary Format

Note that the generation time is in two parts. The first part (octets 0-3) is the number of seconds since epoch (1<sup>st</sup> Jan 1970) and the second part (octets 4-7) is the number of microseconds.

## 6.2 XML

This section identifies the EDDS data types that support XML formatting and provides references to associated schemas (found in Appendix C)

### 6.2.1 Packet

- Statistics - The packet statistics data type supports XML formatting, see the PacketStatistics schema Appendix C
- TC / TM / EV PARC Raw – This data type supports XML formatting only. See the PktRawResponse schema Appendix C
- TC / TM / EV / OOL Reports – These data types supports XML formatting only. See the PktTcReportResponse, PktTmReportResponse, EventRecordReportResponse and OolDataReportResponse schemas in Appendix C respectively.

### 6.2.2 Parameter

- Param – The parameter data type supports XML formatting, see the Param schema Appendix C.
- Statistics - The parameter statistics data type supports XML formatting, see the ParameterStatistics schema Appendix C.
- Definition - The parameter definition data type supports XML formatting, see the ParameterDefinitionType schema Appendix C.
- Preview - The parameter preview data type supports XML formatting, see the ParameterPreview schema Appendix C
- SMON Parameter - The parameter data type supports XML formatting, see the SMONParamResponse schema Appendix C

#### 6.2.2.1 A special note on times shown in the response files

There are a number of times shown in the output of the DARC Param response file:

- Generation time: for DARC sources, this corresponds to the parameter generation time. For SMON sources, this corresponds to the sample time (i.e. the packet generation time (filing time) plus an offset for supercommutated packets)
- Storage time: for DARC sources, this corresponds to the DARC storage time. For SMON sources, this corresponds to the create time (i.e. the PARC storage time)
- Parent generation time: for DARC sources, this corresponds to the packet generation time. For SMON sources, this corresponds to the packet generation time (filing time)

## 6.2.3 Report

The EDDS provides access to EDDS generated reports.

### 6.2.3.1.1 EDDS Report

EDDS reports are generated by the EDDS on user request. All EDDS reports are in XML format and are packaged within an EDDS XML EddsReport type. The XML schema of the report type can be found in Appendix I. The reports that may be packaged within the EddsReport are as follows:



### 6.2.3.1.1.1 Request Summary Report

The XML schema AcknowledgementPart defines the structure and content of an EDDS XML request summary report type.

EDDS provides two views of Request Summary Reports: a brief and a full summary report. The full summary report displays the complete acknowledgement message, while the brief is a subset of info from the acknowledgement message.

The detailed structure of the AcknowledgementPart is defined in the Section A.1

### 6.2.3.1.1.2 EDDS Usage Report

The XML schema EddsUsageReport defines the structure and content of an EDDS XML usage report type. See I.2.

A usage report contains information about the usage of the EDDS services over a given period:

<i>Field</i>	<i>Type</i>	<i>Description</i>
Total Deleted Requests	Integer	Total number of deleted requests over the period
Total Processed Requests	Integer	Total number of processed requests over the period.
Total Failed Requests	Integer	Total number of failed requests over the period
The following is within the EddsUsageReportList element, within zero or more EddsUsageReportListElement elements.		
RequestId	String	The ID of the request
User	String	The username of the user who submitted the request
Role	String	The name of the role used for the request
Status	String	The final status of the request
SizeOfResponseFile	Integer	The size of the response file in bytes
SubmissionDate	Date	The date the request was submitted to the server
ExecutionDate	Date	The date the request was executed
CompletionData	Date	The date the request was completed

Table 14 - EDDS Usage Report

## 6.2.4 Archived Files

The EDDS provides access to catalogues and files of MCS file archives. The catalogue data type supports XML formatting. The corresponding XML schema, Catalogue, defines the structure and content of an EDDS XML catalogue data type. See C.1, C.2 and C.3.

Note: Files from an MCS archive are passed to the end user as retrieved from the MCS file archive. This implies that a file could of course be an XML document. The definition of the content of MCS files is mission-specific and is outside the scope of this ICD.

## 6.2.5 File System

The EDDS provides access to a designated directory on the file system of EDDS Server. The File and Folder Catalogue requests support XML formatting option.

## 6.2.6 Acknowledgement

An EDDS acknowledgement is an XML document. The structure and content is described in the XML schema acknowledgement.xsd. See A.1 for detailed information.

### 6.3 XML Transform

All the requests that support XML format also support XML transformations. Custom stylesheets can be added to the EDDS Server for transforming the XML responses. Available list of transformations can be retrieved through the `EddsService.getTransformations()` method in the Client API.

### 6.4 XFDU

The XFDU format is a schema that allows existing data to be packaged up with further information such as the original system used, the filename and a checksum. The XFDU schema is an external schema and can be found in the document “CCSDS, XML Formatted Data Unit (XFDU) Structure and Construction Rules” [AD-1]. EDDS supports a post processing option that, when selected, will create an XML file compliant with this schema.

### 6.5 TDRS Spreadsheet

The EDDS supports the formatting of data types (Parameters) into the TDRS spreadsheet format. The format is a text file containing tab delimited fields (columns) with new lines separating rows. See Appendix M for more information.

### 6.6 ASCII

The EDDS supports ASCII representation of data types. The contents of the ASCII files is similar to the equivalent XML files, but without the XML markup.

For the TC Report, the ASCII format is based on the Command History application found in SCOS 5.3/5.4. Full information on this format can be found in the SCOS 2000 Command History Operator User Manual, with the most useful information copied here for convenience.

The following snippet shows an example of this format:

```
Name      Description          S D C G B IL ST Source          FC TC Q R GTO A SS 1122 CC
S2KTC007 TC(3,3)          E E E      SR MS de-vm140          00 01  S SSS S              S
  S2KCP013 Housekeeping SID      Eng      Dec          HK_SID_1
```

To save space, the columns “Sequence, Domain, Release Time and Execution Time” have been removed from the output. The first line provides the column headings, and the following line is the values for a TC packet. The final indented line shows the parameters for the TC packet. These can be removed from the output by selecting “Get brief summary only” in the TC Report request.

The following table describes the column headings after “Description”:

Column	Description	
S	Static PTV Check State (E => Enabled, D => Disabled or O => Overridden)	
D	Dynamic PTV Check State (E => Enabled, D => Disabled or O => Overridden)	
C	CEV Check State (E => Enabled or D => Disabled)	
G	Group flag value (G => in a group, E => last in a group)	
B	Block flag value (B => in a block, E => last in a block)	
IL	Interlock Status, two characters, the first reports the interlock type and scope, the second, the interlock stage type.	
	Interlock Type and Scope	
	L	Wait-Fail Local
	G	Wait-Fail Global
	S	Wait-Fail Subsystem Local
F	Fail-Only Local	

	T	Fail-Only Subsystem Local
	Interlock Stage Type	
	R	1st UV stage: Ground Stn. Reception
	U	2nd UV stage: Uplink
	O	3rd UV stage: On Board Reception
	A	Execution Ver.: Acceptance
	C	Execution Ver.: Completion
ST	Source Type (MS => Man.Stack, AS => Auto Stack)	
Source	Source workstation ID	
FC	Frame Counter: indicating current frame count. Only applicable for CLTU AD mode	
TC	Transmission Counter: indicating the current number of (re)transmission. Only applicable for CLTU AD mode.	
Q	This column will show an asterisk (*) should any of the verification stages be anything other than "Success (S)" or not applicable (blank).	
Verification Status Headings		
	<p>The status of each individual verification stage may have one of the following values:</p> <p>F      Fail</p> <p>U      Unverified</p> <p>X      Unknown</p> <p>P      Pending</p> <p>T      Time-out</p> <p>S      Success</p> <p>I      Idle</p> <p>A      Assumed Passed</p> <p>C      Affected</p> <p>V      Uncertain Successful</p> <p>N      Uncertain Failed</p> <p>E      Superseded</p> <p>Blank N/A</p> <p>The following behaviour of a time-tagged commands verification status are extended:</p> <ul style="list-style-type: none"> <li>• If a time-tagged command is deleted prior to execution, a string "DELETED" is showed in verification stage field</li> <li>• If a time-tagged command is disabled at execution, EV stages are marked as "D"</li> </ul>	
R	<p>Release from SCOS-2000 to the SLE User (NCTRS/NIS). Note that a failure for this stage may be caused by one of the following reasons:</p> <ul style="list-style-type: none"> <li>• PTV NOT OK at release time (the PTV state is visible in the CQD)</li> <li>• PTV/CEV pane, see Section 3.1.3.3 below)</li> <li>• PTV OK (e.g. dynamic PTV was overridden) but no TCP/IP connection between the releaser and the NCTRS was available at release time</li> <li>• The command was successfully released but eventually rejected by the NCTRS e.g. because the required connection to the station equipment was</li> </ul>	

	not available at release time. In this case an administrative message is also received from the NCTRS and logged in the HFA
G	Ground station reception (UV 1st stage)
T	Uplink a.k.a. radiation (UV 2nd stage) and in case of Throw Event Command it corresponds to the Execution stage.
O	On-board reception a.k.a. transfer (3rd UV stage, only applicable in AD mode)
A	On-board application acceptance
SS	Execution start – two instances of the stage are shown, one corresponding to updates from Real Time and the other corresponding to updates from Playback TM
1122	Execution step „n“ – two instances of each stage are shown, one corresponding to updates from Real Time and the other corresponding to updates from Playback TM
CC	Execution completion – two instances of the stage are shown, one corresponding to updates from Real Time and the other corresponding to updates from Playback TM

Table 15 – TC Report ASCII column output

## 6.7 Binary

Binary format is specific to each of the request types.

### 6.7.1 Archive File

The file is stored as received from the mission File Archive, packaged in a TAR file.

### 6.7.2 File System

The files are stored as received from the file system, packaged in a TAR file.

### 6.7.3 Google Proto Buffers

Google Protocol Buffers binary format is used to deliver data in an efficient format. Compared to XML format it is more compact and faster to process in case of large data volumes. The proto files describing the data structure are stored in edds-ws-common and are compiled as a part of the build process. Data is encoded as a framed byte array. Helper classes are provided in project edds-ws-client in package esa.egos.edds.ws.client.binary to simplify working with binary format.

#### 6.7.3.1 Header line

Each EDDS binary file has ASCII encoded header line included to provide simple interaction by external applications. Format of header line is simple key value pairs separated by semicolons:

```
# Key1: Value1; ... ; KeyN: ValueN \n
```

- Header line starts with # (byte value 23 in HEX) and space (byte value 20 in HEX)
- Each key value pair ends with semicolon (byte value 3B in HEX) and optional space (byte value 20 in HEX)
- Key is separated from value with colon (byte value 3A in HEX) and optional space (byte value 20 in HEX)
- Header line ends with single line feed character (byte value A0 in HEX)
- Currently supported keys are:
  - Type – data type in binary format (current supported values are Parameter and SMON Parameter)
  - Version – version of binary format

### 6.7.3.2 Data

Data format is based on Google Protocol Buffers (GPB, see [RD-16]). The file contains the list of serialized GPB DarcParameterBinary objects, each of them prefixed with its size in bytes, the value is in GPB varint format.

Note that Google Protocol Buffer encoded files are not intended to be decoded manually. Instead, the original Proto file describing the format in plain text should be compiled and the Google Protocol Buffers library should be used instead. The Proto file describing this format is provided in the EDDS source code within the edds-ws-common package. For more information on Google Protocol Buffers, see [RD-16].

### 6.7.3.3 Specific formats

#### 6.7.3.3.1 Parameter TM

Protobuf format is used to deliver Parameter TM data efficiently. Binary is one of the available formats Parameter TM request submitter can choose from.

##### 6.7.3.3.1.1 Data

Following is the GPB DarcParameterBinary message definition:

```
message DarcParameterBinary {
  enum Validity {
    VALID = 0;
    INVALID = 1;
    UNKNOWN = 2;
    EXPIRED = 3;
  }

  enum Type {
    // Special type indicating that the proto type definition should
    be updated to include a new type
    UNKNOWN = 0;
    BIT = 1;
    UTINYINT = 2;
    STINYINT = 3;
    USMALLINT = 4;
    SSMALLINT = 5;
    UMEDIUMINT = 6;
    SMEDIUMINT = 7;
    SINT = 8;
    UINT = 9;
    FLOAT = 10;
    DOUBLE = 11;
    STRING = 12;
    DATETIME = 13;
    JOB = 14;
  }
}
```

```

        LOG = 15;
    }

    required string param_name = 1;
    required int64 gen_time = 2;
    required int64 storage_time = 3;
    required string value = 4;
    required Validity validity = 5;
    required Type type = 6;

    // Following are not present in DARC v2.2.2 and earlier
    optional int64    parentGenTime = 7; // SCOS TM packet generation time
    optional int64    parentId = 8; // SPID in PARC
    optional Type     rawValType = 9;
    optional bool     boolRawVal = 10;
    optional string   strRawVal = 11;
    optional double   dblRawVal = 12;
    optional float    fltRawVal = 13;
    optional sint64   longRawVal = 14;
}

```

#### 6.7.3.3.1.2 Decoding Files

Note that it is not necessary to manually decode these files! EDDS provides an API in the edds-ws-client to decode them. It is also possible to decode the files using Google Protocol Buffers libraries for many other languages including Python, Perl and C++.

First line	# Type: Parameter; Version: 1;	Header line for the binary file format
Rest of file	Binary data	<a href="#">Framed Google Protocol Buffers encoded data.</a> The encoded data is prefixed with the length of the message so that multiple messages can be included in one file. This functionality is provided by the Apache ActiveMQ implementation.

#### 6.7.3.3.2 Parameter TM Definitions

Protobuf format is used to deliver Parameter TM definitions data efficiently. Binary is one of the available formats Parameter TM Definitions request submitter can choose from.

##### 6.7.3.3.2.1 Data

Following is the GPB ParamDefinitions message definition:

```

message ParamDefinitionRecord
{
    optional string name = 1;
    optional string description = 2;
}

```

```
    optional string unit = 3;
    optional string type = 4;
    optional bool active = 5;
}

message ParamDefinitions
{
    repeated ParamDefinitionRecord entry = 1;
}
```

### 6.7.3.3.3 SMON Parameter

The Protobuf format is used to deliver Parameter TM data from SMON efficiently. Binary is one of the available formats that the SMON Parameter request can choose from. It is also possible to choose the DARC Binary format, so that the output from the SMON Parameter request is compatible with programs that can read DARC Binary data files. See Section 6.7.3.3.1 for details of that format.

#### 6.7.3.3.3.1 Data

Following is the GPB SMONParameter message definition:

```
message SMONParameterBinary
{
    required string name = 1;
    required string calib_id = 2;
    repeated PacketInstanceBinary packet_instances = 3;
    repeated RepresentationSampleBinary representation_samples = 4;

    enum ValidityValueBinary {
        UNKNOWN = 0;
        VALID = 1;
        INVALID = 3;
        EXPIRED = 4;
    }

    message PacketInstanceBinary {
        required string reception_time = 1;
        required string generation_time = 2;
        required int32 sample_offset = 3;
        required int32 sequence_counter = 4;
        required int32 spacecraft_id = 5;
        required SMONParameterBinary.ValidityValueBinary validity = 6;
        required int32 data_stream = 7;
        required int32 domain = 8;
        required int32 packet_size = 9;
    }
}
```

```
    required string ground_station = 10;
    required string packet_mnemonic = 11;
}

message RepresentationSampleBinary {
    required string representation_name = 1;
    required string sample_time = 2;
    required string value = 3;

    message Validity {

        required SMONParameterBinary.ValidityValueBinary validity = 1;
        required string validity_details = 2;

    }
    required Validity validity = 4;

    message BehaviourState {
        required string status_type = 1;

        enum GeneralBehaviourStateBinary {
            INCONSISTENT_STATUS = 0;
            NOMINAL = 1;
            OUT_OF_LIMIT = 2;
            UNCHECKED = 3;
            UNDEFINED = 4;
            VIOLATED = 5;
            WARNING = 6;
        }
        required GeneralBehaviourStateBinary ool_state = 2;

        required int32 nr_of_violations = 3;
        required string value = 4;

        message DetailedBehaviourStateBinary {
            optional LimitBehaviourStateBinary limitState = 1;
            optional StatusBehaviourStateBinary statusState = 2;
            optional SCCBehaviourStateBinary sccState = 3;
            optional DeltaBehaviourStateBinary deltaState = 4;
```



```
enum LimitBehaviourStateBinary {
    WITHIN_RANGE = 0;
    LOW = 1;
    HIGH = 2;
    LOW_LOW = 3;
    HIGH_HIGH = 4;
}

enum StatusBehaviourStateBinary {
    ALLOWED = 0;
    UNEXPECTED = 1;
}

enum SCCBehaviourStateBinary {
    SCC_ENABLE = 0;
    SCC_UNINIT = 1;
    SCC_DISABLE = 2;
    SCC_OFF = 3;
    SCC_FAIL = 4;
}

enum DeltaBehaviourStateBinary {
    DELTA_ALLOWED = 0;
    DELTA_EQUAL = 1;
    MAX_DELTA_LOW = 2;
    MAX_DELTA_HIGH = 3;
    MIN_DELTA_LOW = 4;
    MIN_DELTA_HIGH = 5;
}

required DetailedBehaviourStateBinary detailed_state = 5;
}

repeated BehaviourState behaviour_states = 5;
}

}
```

#### 6.7.3.3.4 Event Record Report

The Protobuf format is used to deliver packet TM data from PARC efficiently. Binary is one of the available formats that the Event Record Report request can choose from.

#### 6.7.3.3.4.1 Data

Following is the GPB `EventRecordReport` message definition:

```
message EventRecordReportBinary
{
  optional string id = 1;
  optional string domain = 2;
  optional int64 generation_time = 3;
  optional string application = 4;
  optional string severity = 5;
  optional string type = 6;
  optional string workstation = 7;
  optional string message = 8;
}
```

#### 6.7.3.3.5 Packet Raw

The Protobuf format is used to deliver raw packet data from PARC efficiently. Binary is one of the available formats that the Packet TC Raw, Packet TM Raw and Packet EV Raw requests can choose from.

##### 6.7.3.3.5.1 Data

Following is the GPB `PacketRaw` message definition:

```
message PacketRawBinary
{
  optional string packet = 1;
  optional int64 packet_id = 2;
}
```

#### 6.7.3.3.6 Packet TC Report

The Protobuf format is used to deliver packet TC report data from PARC efficiently. Binary is one of the available formats that the Packet TC Report request can choose from.

##### 6.7.3.3.6.1 Data

Following is the GPB `PacketTCReport` message definition:

```
message PacketTCBinary
{
  optional string command_name = 1;
  optional string domain = 2;
  optional string source = 3;
  optional string description = 4;
  optional string sequence_name = 5;
  optional string release_time = 6;
  optional string uplink_time = 7;
  optional string execution_time = 8;
  optional string sub_system_id = 9;
  optional int64 sub_schedule_id = 10;
  optional int32 p_uSService_type = 11;
  optional int32 p_uSSub_service_type = 12;
  optional int32 apid = 13;
  optional int32 pid = 14;
  optional int32 vcid = 15;
  optional int32 category = 16;
  optional int32 ground_station_id = 17;
  optional int32 ssc = 18;
  optional string db_version = 19;
  optional string uplink_mode = 20;
  optional string static_ptv_check_state = 21;
}
```

```

optional string dynamic_ptv_check_state = 22;
optional string cev_check_state = 23;
optional bool is_in_group = 24;
optional bool is_group_end = 25;
optional bool is_in_block = 26;
optional bool is_block_end = 27;
optional string interlock_type = 28;
optional string interlock_stage_type = 29;
optional string src_type = 30;
optional string frame_count = 31;
optional string release_state = 32;
optional string ground_state = 33;
optional string uplink_state = 34;
optional string on_board_state = 35;
optional string on_board_acc_state = 36;
optional string exec_start_rt_state = 37;
optional string exec_start_pb_state = 38;
optional string exec_step1_rt_state = 39;
optional string exec_step1_pb_state = 40;
optional string exec_step2_rt_state = 41;
optional string exec_step2_pb_state = 42;
optional string exec_comp_state = 43;
optional string exec_comp_pb_state = 44;
optional string tt_obq_status = 45;
repeated PktTcReportParameterBinary pkt_tc_report_parameters = 46;
optional int32 trans_count = 47;

message PktTcReportParameterBinary {
  optional string parameter_name = 1;
  optional string parameter_description = 2;
  optional string parameter_unit = 3;
  optional string param_type = 4;
  optional string param_rep = 5;
  optional bool fix_edit = 6;
  optional bool has_changed = 7;
  optional string radix = 8;
  optional bool is_editable = 9;
  optional bool manually_edited = 10;
  optional string param_value = 11;
}
}

```

### 6.7.3.3.7 Packet TM Report

The Protobuf format is used to deliver packet TM report data from PARC efficiently. Binary is one of the available formats that the Packet TM Report request can choose from.

#### 6.7.3.3.7.1 Data

Following is the GPB `PacketTMReport` message definition:

```

message PacketTMBinary
{
  optional int32 apid = 1;
  optional int32 pid = 2;
  optional int32 category = 3;
  optional string database_version = 4;
  optional string generation_time = 5;
  optional string data_stream = 6;
  optional string domain = 7;
  optional string ground_station = 8;
  optional string quality_flag = 9;
}

```

```

optional string reception_time = 10;
optional string sle_service_id = 11;
optional int32 source_sequence_counter = 12;
optional int64 spid = 13;
optional int32 type = 14;
optional int32 sub_type = 15;
optional string time_quality = 16;
optional string virtual_channel = 17;
optional string data_unit_type = 18;
optional int32 pi1 = 19;
optional int32 pi2 = 20;
optional int32 packet_length = 21;
}

```

### 6.7.3.3.8 Packet TM Gap Report

The Protobuf format is used to deliver packet TM gap report data from PARC efficiently. Binary is one of the available formats that the Packet TM Gap Report request can choose from.

#### 6.7.3.3.8.1 Data

Following is the GPB PacketTMGapBinary message definition:

```

message PacketTMGapBinary
{
    optional int64 start_gap_time = 1;
    optional int64 end_gap_time = 2;
    optional int32 data_partition = 3;
    optional int32 apid = 4;
    optional int32 start_ssc_pkt = 5;
    optional int32 end_ssc_pkt = 6;
    optional int32 num_pkts_missing = 7;
}

```

### 6.7.3.3.9 Out of Limit Record Report

The Protobuf format is used to deliver packet OOL report data from PARC efficiently. Binary is one of the available formats that the OOL Report request can choose from.

#### 6.7.3.3.9.1 Data

Following is the GPB OOLReport message definition:

```

message OOLReportBinary {
    message OOLReportRecord {
        enum OOLRecordType {
            NO_VALUE = 0;
            LIMIT = 1;
            STATE = 2;
            STATUS_CONSISTENCY = 3;
            SOFT_HARD_LIMIT = 4;
            LIMIT_MO = 5;
            DELTA = 6;
        }

        enum OOLParameterState {
            NOMINAL = 0;
            WARNING = 1;
            OUT_OF_LIMITS = 2;
            SCC = 3;
            SCC_DISABLE = 4;
            SCC_OFF = 5;
            SCC_UNINIT = 6;
        }
    }
}

```

```
        VIOLATION = 7;
        NO_VALUE = 8;
    }

    optional OOLRecordType record_type = 1;
    optional int64 generation_time = 2;
    optional int64 parameter_changed_time = 3;
    optional string parameter_name = 4;
    optional OOLParameterState parameter_state = 5;
    optional string ool_state = 6;
    optional string value = 7;
    optional double lower_limit = 8;
    optional double upper_limit = 9;
    optional string allowed_values = 10;
    optional string scc_limit = 11;
    optional double reference_value = 12;
    optional double delta_value = 13;
    optional double min_value = 14;
    optional double last_value = 15;
    optional int32 violation_number = 16;
    optional int32 violation_number_hard = 17;
    optional int32 violation_number_soft = 18;
    optional string description = 19;
    optional string unit = 20;
}

repeated OOLReportRecord records = 1;
}
```

## 7. Naming Conventions

### 7.1 Request ID Convention

The Request ID is formed using the information in the following table:

<b>Field</b>	<b>Type</b>	<b>Possible Values</b>
RequestType	String	BatchRequest, StreamRequest, Cancel, DeleteData, DeleteRequest, AccountRequest
Subtype	String	Taken from DataAccessDataElement (See Section D.20)
Mission	String	Any alphanumeric value
Domain	String	Typically numbers from 0 – 51
Username	String	The user ID of the user performing the request
Time	String	Time of the creation of the request in DOY form in GMT

Table 16 – Request ID Convention

The Request ID can either be on of the following two formats:

```
[RequestType].[Username].[yyyy.DDD.hh.mm.ss.SSS]
```

Or

```
[RequestType].[Subtype].[Mission].[Domain].[yyyy.DDD.hh.mm.ss.SSS]
```

The first form is used for changes to user and mission LDAP account information (AccountRequest types) and the other form is used for all other request types. The Request ID is created by the EDDS Archiver (by the ScheduleUtility class) when the request is added to the database.

### 7.2 Response ID Convention

The Response ID is formed using the information in the following table:

<b>Field</b>	<b>Type</b>	<b>Possible Values</b>
RequestId	RequestId	Same as Section 7
Time	String	Time the response file was created in DOY form in GMT
Counter	Int	The response file number, starting at 1.
Extension	String	The file type

Table 17 – Response ID Convention

The Response ID is in the following format:

```
[RequestType].[Subtype].[Mission].[Domain].[yyyy.DDD.hh.mm.ss.SSS]@[yyyy.DDD.hh.mm.ss.SSS].[Counter].[Extension]
```

## **8. Delivery**

### **8.1 Delivery Mechanism**

The EDDS supports the following delivery mechanisms for the delivery of data to the end user.

The batch request response data can be delivered to the user via File Server or EDDS Server each file separately as soon as EDDS Server is finished processing a file and it is available for Delivery Manager.

#### **8.1.1 File Server**

Data types that support the 'File Server' delivery mechanism are delivered over SFTP or FTP using the EDDS web server. Direct delivery requires the end user to be running a server that supports SFTP/FTP.

In order to use SFTP the user has to provide username and password of the remote file server. In case these data is not provided, the web server will automatically try to use FTP.

#### **8.1.2 EDDS Server**

Data types that support the EDDS Server delivery mechanism are stored on an EDDS server. Also when the File Server delivery fails, the data is still stored in EDDS file server.

#### **8.1.3 Stream**

Data types that support Stream delivery require the end user to run a stream client application that can be downloaded from the EDDS web site and installed on the user's machine. Stream delivery supports online and offline data where, in the context of the EDDS, offline is taken to refer to the retrieval of previously archived data and online is taken to refer to the routing of data as it is received on the relevant control system. In addition, online data delivery supports two modes of operation: timely and complete. Timely mode ensures data is delivered within a specified time and will drop data if this criterion cannot be met. Complete mode ensures all data is delivered, although there may be considerable delay in the arrival of the complete data set.

## 9. Web Services Description

The EDDS uses web services as the fundamental mechanism to provide the functionality behind EDDS batch services and EDDS stream services. This section of the EUICD details the structure of the EDDS Web Services.

### 9.1 Web Service Introduction

The EDDS provides access to data via Web Services that are defined using Web Services Description Language (WSDL) see [RD-3]. The Web Services described in this section of the document allows client applications access to batch and user management services.

The services provide operations that allow a client to be authenticated, make requests for batch data, make requests for stream data, perform user management and receive data in response to those requests.

A WSDL service description is an XML document that contains a set of definitions for:

- Port Types
- Messages
- Bindings
- Services

A port type is a named set of abstract operations and the abstract messages involved. Message definitions are always considered to be an abstract definition of the message content. A message binding describes how the abstract content is mapped into a concrete format. However, in the case of the EDDS the content is intended to map directly onto the XML schemas. The bindings provide the protocol details for operations and messages defined by a particular port type. In the case of the EDDS, the bindings are to a SOAP protocol using XML messages. Finally, a service definition groups a set of related ports together. The definition of the EDDS Web Services is defined in the XML documents,

Port operations defined by EDDS provide a means to indicate if an error has occurred during the request of an operation.) An exception is raised when a service request cannot be executed with success.

The WSDL file can be viewed in a web browser by simply entering the end point URL normally passed to the client application into the web browser's address bar.

### 9.2 PortTypes

A port type is a named set of abstract operations and the abstract messages involved. The port type name attribute provides a unique name among all port types defined within in the enclosing service definition document. WSDL has four transmission primitives that an endpoint can support:

- One-way - The endpoint receives a message.
- Request-response - The endpoint receives a message, and sends a correlated message.
- Solicit-response - The endpoint sends a message, and receives a correlated message.
- Notification - The endpoint sends a message.

WSDL refers to these primitives as operations.

The operation instances defined in the EDDS port types are based on 'one-way' and 'request-response' transmission primitives. The following sections describe the port types that have been defined for the EDDS.

#### 9.2.1 EDDS Port Type

The EDDS port type provides the operations that allow the authentication of a user and subsequent allocation of a session identifier. All users of the EDDS are assigned a session and it is under this



session that a series of operations are made. A session will be timed out by the EDDS server if inactive, however it is strongly recommended that applications should actively close the session when appropriate. This ensures that server resources are freed as soon as possible to service new session requests. Not following this guideline will result in the potential delaying (or rejection) of session requests. The timeout period of sessions can be changed by the EDDS Administrator in the EDDS Web Server configuration in the file "web.xml". The authentication port type also provides operations for the client to query the roles and missions available within the session.

The EDDS port type is a component that is used by both batch and stream services.

It provides the set of operations available for the request and receipt of data (and acknowledgements) within the scope of an EDDS batch service.

It provides the set of operations available for the execution of user management requests.

### 9.2.1.1 EddsPortType

The EDDS port type describes the named set of messages that a service sends and/or receives

operations	<p><b>batchRequest</b></p> <p><i>The batch request operation</i></p> <p>input <a href="#">ws:batchRequest</a></p> <p>output <a href="#">ws:batchRequestResponse</a></p> <p>fault <a href="#">ws:requestFault</a></p> <p><i>An error occurs during the elaboration of the request</i></p> <p>fault <a href="#">ws:authorizationFault</a></p> <p><i>If the user has no privileges to perform the request</i></p> <p>fault <a href="#">ws:sessionFault</a></p> <p><i>If the user is not logged in</i></p> <p><b>streamRequest</b></p> <p><i>The stream request operation</i></p> <p>input <a href="#">ws:streamRequest</a></p> <p>output <a href="#">ws:streamRequestResponse</a></p> <p>fault <a href="#">ws:requestFault</a></p> <p><i>An error occurs during the elaboration of the request</i></p> <p>fault <a href="#">ws:authorizationFault</a></p> <p><i>If the user has no privileges to perform the request</i></p> <p>fault <a href="#">ws:sessionFault</a></p> <p><i>If the user is not logged in</i></p>
------------	---

## getStatus

*The get status operation*

input [ws:getStatus](#)  
output [ws:getStatusResponse](#)  
fault [ws:requestFault](#)

*An error occurs during the elaboration of the request*

fault [ws:authorizationFault](#)

*If the user has no privileges to perform the request*

fault [ws:sessionFault](#)

*If the user is not logged in*

## reSubmit

*The re-submit operation*

input [ws:reSubmit](#)  
output [ws:reSubmitResponse](#)  
fault [ws:requestFault](#)

*An error occurs during the elaboration of the request*

fault [ws:authorizationFault](#)

*If the user has no privileges to perform the request*

fault [ws:sessionFault](#)

*If the user is not logged in*

## getStatuses

*Gets the status of a list of jobs*

input [ws:getStatuses](#)  
output [ws:getStatusesResponse](#)  
fault [ws:requestFault](#)

*An error occurs during the elaboration of the request*

fault [ws:authorizationFault](#)

*If the user has no privileges to perform the request*

fault [ws:sessionFault](#)

*If the user is not logged in*

### **getResponse**

*The get response operation*

input [ws:getResponse](#)

output [ws:getResponseResponse](#)

fault [ws:requestFault](#)

*An error occurs during the elaboration of the request*

fault [ws:authorizationFault](#)

*If the user has no privileges to perform the request*

fault [ws:sessionFault](#)

*If the user is not logged in*

### **getRequest**

*The get request operation*

input [ws:getRequest](#)

output [ws:getRequestResponse](#)

fault [ws:requestFault](#)

*An error occurs during the elaboration of the request*

fault [ws:authorizationFault](#)

*If the user has no privileges to perform the request*

fault [ws:sessionFault](#)

*If the user is not logged in*

### **getStreamRequest**

*The get stream request operation*

input [ws:getStreamRequest](#)

output [ws:getStreamRequestResponse](#)

fault [ws:requestFault](#)

*An error occurs during the elaboration of the request*

fault [ws:authorizationFault](#)

*If the user has no privileges to perform the request*

fault [ws:sessionFault](#)

*If the user is not logged in*

### **startStreamData**

*Starts the incoming stream of the specified active stream request*

input [ws:startStreamData](#)

output [ws:startStreamDataResponse](#)

fault [ws:requestFault](#)

*An error occurs during the elaboration of the request*

fault [ws:authorizationFault](#)

*If the user has no privileges to perform the request*

fault [ws:sessionFault](#)

*If the user is not logged in*

### **stopStreamData**

*Stops the incoming stream of the specified active stream request*

input [ws:stopStreamData](#)

output [ws:stopStreamDataResponse](#)

fault [ws:sessionFault](#)

*If the user is not logged in*

### **getParamDefinitions**

*Gets the parameter definitions for the specified mission*

input [ws:getParamDefinitions](#)

output [ws:getParamDefinitionsResponse](#)

fault [ws:requestFault](#)

*An error occurs during the elaboration of the request*

fault [ws:authorizationFault](#)

*If the user has no privileges to perform the request*

fault [ws:sessionFault](#)

*If the user is not logged in*

### **getCatalogue**

*Gets the catalogue for the specified data source*

input [ws:getCatalogue](#)

output [ws:getCatalogueResponse](#)

fault [ws:requestFault](#)

*An error occurs during the elaboration of the request*

fault [ws:authorizationFault](#)

*If the user has no privileges to perform the request*

fault [ws:sessionFault](#)

*If the user is not logged in*

### **getFarcCatalogue**

*Gets the FARC catalogue for the specified mission and domain  
@deprecated use getCatalogue instead*

input [ws:getFarcCatalogue](#)

output [ws:getFarcCatalogueResponse](#)

fault [ws:requestFault](#)

*An error occurs during the elaboration of the request*

fault [ws:authorizationFault](#)

*If the user has no privileges to perform the request*

fault [ws:sessionFault](#)

*If the user is not logged in*

### **getDataspaces**

*Gets the dataspaces for the specified mission and request type*

input [ws:getDataspaces](#)

output [ws:getDataspacesResponse](#)

fault [ws:requestFault](#)

	<p><i>An error occurs during the elaboration of the request</i></p> <p>fault <a href="#"><u>ws:authorizationFault</u></a></p> <p><i>If the user has no privileges to perform the request</i></p> <p>fault <a href="#"><u>ws:sessionFault</u></a></p> <p><i>If the user is not logged in</i></p> <p><b>cancel</b></p> <p><i>The cancel operation</i></p> <p>input <a href="#"><u>ws:cancel</u></a></p> <p>output <a href="#"><u>ws:cancelResponse</u></a></p> <p>fault <a href="#"><u>ws:requestFault</u></a></p> <p><i>An error occurs during the elaboration of the request</i></p> <p>fault <a href="#"><u>ws:authorizationFault</u></a></p> <p><i>If the user has no privileges to perform the request</i></p> <p>fault <a href="#"><u>ws:sessionFault</u></a></p> <p><i>If the user is not logged in</i></p> <p><b>suspend</b></p> <p><i>The suspend operation</i></p> <p>input <a href="#"><u>ws:suspend</u></a></p> <p>output <a href="#"><u>ws:suspendResponse</u></a></p> <p>fault <a href="#"><u>ws:requestFault</u></a></p> <p><i>An error occurs during the elaboration of the request</i></p> <p>fault <a href="#"><u>ws:authorizationFault</u></a></p> <p><i>If the user has no privileges to perform the request</i></p> <p>fault <a href="#"><u>ws:sessionFault</u></a></p> <p><i>If the user is not logged in</i></p> <p><b>resume</b></p> <p><i>The resume operation</i></p>
--	---

	<p>input <a href="#"><u>ws:resume</u></a></p> <p>output <a href="#"><u>ws:resumeResponse</u></a></p> <p>fault <a href="#"><u>ws:requestFault</u></a></p> <p><i>An error occurs during the elaboration of the request</i></p> <p>fault <a href="#"><u>ws:authorizationFault</u></a></p> <p><i>If the user has no privileges to perform the request</i></p> <p>fault <a href="#"><u>ws:sessionFault</u></a></p> <p><i>If the user is not logged in</i></p> <p><b>deleteData</b></p> <p><i>The operation to delete response data</i></p> <p>input <a href="#"><u>ws:deleteData</u></a></p> <p>output <a href="#"><u>ws:deleteDataResponse</u></a></p> <p>fault <a href="#"><u>ws:requestFault</u></a></p> <p><i>An error occurs during the elaboration of the request</i></p> <p>fault <a href="#"><u>ws:authorizationFault</u></a></p> <p><i>If the user has no privileges to perform the request</i></p> <p>fault <a href="#"><u>ws:sessionFault</u></a></p> <p><i>If the user is not logged in</i></p> <p><b>deleteRequest</b></p> <p><i>The operation to delete a request</i></p> <p>input <a href="#"><u>ws:deleteRequest</u></a></p> <p>output <a href="#"><u>ws:deleteRequestResponse</u></a></p> <p>fault <a href="#"><u>ws:requestFault</u></a></p> <p><i>An error occurs during the elaboration of the request</i></p> <p>fault <a href="#"><u>ws:authorizationFault</u></a></p> <p><i>If the user has no privileges to perform the request</i></p> <p>fault <a href="#"><u>ws:sessionFault</u></a></p> <p><i>If the user is not logged in</i></p>
--	---

## getJobs

*The get jobs operation*

input [ws:getJobs](#)

output [ws:getJobsResponse](#)

fault [ws:requestFault](#)

*An error occurs during the elaboration of the request*

fault [ws:authorizationFault](#)

*If the user has no privileges to perform the request*

fault [ws:sessionFault](#)

*If the user is not logged in*

## getJobsWithStatus

*Gets the jobs for the specified start and end date. The message contains a java.util.ArrayList of type RequestInfoRec encoded in Base64*

input [ws:getJobs](#)

output [ws:getJobsWithStatusResponse](#)

fault [ws:requestFault](#)

*An error occurs during the elaboration of the request*

fault [ws:authorizationFault](#)

*If the user has no privileges to perform the request*

fault [ws:sessionFault](#)

*If the user is not logged in*

## getHistoricalLog

*Gets the historical system logs*

input [ws:getHistoricalLog](#)

output [ws:getHistoricalLogResponse](#)

fault [ws:requestFault](#)

*An error occurs during the elaboration of the request*

fault [ws:authorizationFault](#)



	<p><i>If the user has no privileges to perform the request</i></p> <p>fault <a href="#">ws:sessionFault</a></p> <p><i>If the user is not logged in</i></p> <p><b>getTransformations</b></p> <p><i>Gets the available XSL Transformations for the given mission and request type</i></p> <p>input <a href="#">ws:getTransformations</a></p> <p>output <a href="#">ws:getTransformationsResponse</a></p> <p>fault <a href="#">ws:requestFault</a></p> <p><i>An error occurs during the elaboration of the request</i></p> <p>fault <a href="#">ws:authorizationFault</a></p> <p><i>If the user has no privileges to perform the request</i></p> <p>fault <a href="#">ws:sessionFault</a></p> <p><i>If the user is not logged in</i></p> <p><b>logIn</b></p> <p><i>Authenticate the user and start the session</i></p> <p>input <a href="#">ws:logIn</a></p> <p><i>The credentials of the user: username and password</i></p> <p>output <a href="#">ws:logInResponse</a></p> <p><i>No response given</i></p> <p>fault <a href="#">ws:authenticationFault</a></p> <p><i>If the username or password are incorrect or the LDAP server could not be reached</i></p> <p>fault <a href="#">ws:passwordExpiredFault</a></p> <p><i>If the user's password has expired and needs to be changed</i></p> <p><b>hasSessionExpired</b></p> <p><i>Checks if the user's session has expired, and return true if it has. This operation has a one-way transport.</i></p> <p>input <a href="#">ws:checkSession</a></p>
--	---

*Input is not used. JAX-WS doesn't support notification style messages.*

output [ws:checkSessionResponse](#)

*Returns true if the session has expired or has not been started*

## **logOut**

*Close the session for the user. This operation has a one-way transport*

input [ws:logOut](#)

## **checkUserPassword**

*Check if the password supplied matches the user's current password. Used to double check the user's current password before allowing the user to change their password.*

input [ws:checkUserPassword](#)

*The user's current password in plain text*

output [ws:checkUserPasswordResponse](#)

*No output given*

fault [ws:authenticationFault](#)

*If the password doesn't match or the LDAP server could not be reached*

fault [ws:sessionFault](#)

*If the user is not logged in*

## **accountRequest**

*The account request operation*

input [ws:accountRequest](#)

*The actual request*

output [ws:accountRequestResponse](#)

fault [ws:authorizationFault](#)

*If the user has no privileges to perform the request*

fault [ws:requestFault](#)

*An error occurs in the elaboration of the request*

fault [ws:sessionFault](#)

*If the user is not logged in*

### **getUsers**

*Retrives the list of users*

input [ws:getUsers](#)

*Flag to indicate whether to fetch all the users*

output [ws:getUsersResponse](#)

*The list of users*

fault [ws:authorizationFault](#)

*If the user has no priviledges to perform the request*

fault [ws:requestFault](#)

*An error occurs in the elaboration of the request*

fault [ws:sessionFault](#)

*If the user is not logged in*

### **getMissions**

*the list of missions*

input [ws:getMissions](#)

*Empty message*

output [ws:getMissionsResponse](#)

*The list of missions*

fault [ws:authorizationFault](#)

*If the user has no priviledges to perform the request*

fault [ws:requestFault](#)

*An error occurs in the elaboration of the request*

fault [ws:sessionFault](#)

*If the user is not logged in*

**getMissionsAndDomains**

*the list of missions with their domains*

input [ws:getMissionsAndDomains](#)

*Empty message*

output [ws:getMissionsAndDomainsResponse](#)

*The list of missions*

fault [ws:authorizationFault](#)

*If the user has no privileges to perform the request*

fault [ws:requestFault](#)

*An error occurs in the elaboration of the request*

fault [ws:sessionFault](#)

*If the user is not logged in*

**getRoles**

*Returns the roles the user has permission to use for the specified mission*

input [ws:getRoles](#)

*The name of the mission*

output [ws:getRolesResponse](#)

*The role details*

fault [ws:authorizationFault](#)

*If the user has no privileges to perform the request*

fault [ws:requestFault](#)

*An error occurs in the elaboration of the request*

fault [ws:sessionFault](#)

*If the user is not logged in*

**getUserAccountDetails**

*Returns the details for the specified user*

input [ws:getUserAccountDetails](#)

*The name of the user*

output [ws:getUserAccountDetailsResponse](#)

*The user's details*

fault [ws:authorizationFault](#)

*If the user has no privileges to perform the request*

fault [ws:requestFault](#)

*An error occurs in the elaboration of the request*

fault [ws:sessionFault](#)

*If the user is not logged in*

### **getMissionDetails**

*Returns the details for the specified mission*

input [ws:getMissionDetails](#)

*The name of the mission*

output [ws:getMissionDetailsResponse](#)

*The mission details*

fault [ws:authorizationFault](#)

*If the user has no privileges to perform the request*

fault [ws:requestFault](#)

*An error occurs in the elaboration of the request*

fault [ws:sessionFault](#)

*If the user is not logged in*

### **getUserQuota**

*Returns the quota usage for the specified mission and logged on user*

	<p>input <a href="#"><b>ws:getUserQuota</b></a></p> <p><i>The name of the mission</i></p> <p>output <a href="#"><b>ws:getUserQuotaResponse</b></a></p> <p><i>The quota details for the mission and logged on user</i></p> <p>fault <a href="#"><b>ws:authorizationFault</b></a></p> <p><i>If the user has no privileges to perform the request</i></p> <p>fault <a href="#"><b>ws:requestFault</b></a></p> <p><i>An error occurs in the elaboration of the request</i></p> <p>fault <a href="#"><b>ws:sessionFault</b></a></p> <p><i>If the user is not logged in</i></p> <p><b>hasPermissionToSeeAllUsers</b></p> <p><i>Checks if user has privileges to see all users data.</i></p> <p>input <a href="#"><b>ws:hasPermissionToSeeAllUsers</b></a></p> <p><i>Username</i></p> <p>output <a href="#"><b>ws:permissionToSeeAllUsersResponse</b></a></p> <p><i>Returns true if the user has permission to see other users data</i></p> <p>fault <a href="#"><b>ws:authorizationFault</b></a></p> <p><i>If the user has no privileges to perform the request</i></p> <p>fault <a href="#"><b>ws:requestFault</b></a></p> <p><i>An error occurs in the elaboration of the request</i></p> <p>fault <a href="#"><b>ws:sessionFault</b></a></p> <p><i>If the user is not logged in</i></p>
used by	binding <a href="#"><b>EddsBinding</b></a>

### 9.3 Messages

This section describes the XML messages that EDDS sends and receive in order to provide services.

### 9.3.1 message accountRequest

*The message contains the details of a account management request*

parts	<b>accountRequest</b> element <b>model:AccountRequestMessagePart</b>
used by	Operation <a href="#">accountRequest</a> in PortType <a href="#">EddsPortType</a>
source	<pre>&lt;wsdl:message name="accountRequest"&gt;   &lt;wsdl:documentation&gt;The message contains the details of a account management   request&lt;/wsdl:documentation&gt;   &lt;wsdl:part name="accountRequest" element="model:AccountRequestMessagePart"/&gt; &lt;/wsdl:message&gt;</pre>

### 9.3.2 message accountRequestResponse

*Empty message*

parts	
used by	Operation <a href="#">accountRequest</a> in PortType <a href="#">EddsPortType</a>
source	<pre>&lt;wsdl:message name="accountRequestResponse"&gt;   &lt;wsdl:documentation&gt;Empty message&lt;/wsdl:documentation&gt; &lt;/wsdl:message&gt;</pre>

### 9.3.3 message authenticationFault

*The message contains details related to a authentication fault*

parts	<b>authenticationFault</b> element <b>model:AuthenticationFault</b>
used by	Operation <a href="#">logIn</a> in PortType <a href="#">EddsPortType</a> Operation <a href="#">checkUserPassword</a> in PortType <a href="#">EddsPortType</a>
source	<pre>&lt;wsdl:message name="authenticationFault"&gt;   &lt;wsdl:documentation&gt;The message contains details related to a authentication   fault&lt;/wsdl:documentation&gt;   &lt;wsdl:part name="authenticationFault" element="model:AuthenticationFault"/&gt; &lt;/wsdl:message&gt;</pre>

### 9.3.4 message authorizationFault

*The message contains details related to a authorization fault*

parts	<b>authorizationFault</b> element <b>model:AuthorizationFault</b>
used by	Operation <a href="#">batchRequest</a> in PortType <a href="#">EddsPortType</a> Operation <a href="#">streamRequest</a> in PortType <a href="#">EddsPortType</a> Operation <a href="#">getStatus</a> in PortType <a href="#">EddsPortType</a> Operation <a href="#">getStatuses</a> in PortType <a href="#">EddsPortType</a>

	<p>Operation <a href="#">getResponse</a> in PortType <a href="#">EddsPortType</a></p> <p>Operation <a href="#">getRequest</a> in PortType <a href="#">EddsPortType</a></p> <p>Operation <a href="#">getStreamRequest</a> in PortType <a href="#">EddsPortType</a></p> <p>Operation <a href="#">startStreamData</a> in PortType <a href="#">EddsPortType</a></p> <p>Operation <a href="#">getParamDefinitions</a> in PortType <a href="#">EddsPortType</a></p> <p>Operation <a href="#">getFarcCatalogue</a> in PortType <a href="#">EddsPortType</a></p> <p>Operation <a href="#">cancel</a> in PortType <a href="#">EddsPortType</a></p> <p>Operation <a href="#">suspend</a> in PortType <a href="#">EddsPortType</a></p> <p>Operation <a href="#">resume</a> in PortType <a href="#">EddsPortType</a></p> <p>Operation <a href="#">deleteData</a> in PortType <a href="#">EddsPortType</a></p> <p>Operation <a href="#">deleteRequest</a> in PortType <a href="#">EddsPortType</a></p> <p>Operation <a href="#">getJobs</a> in PortType <a href="#">EddsPortType</a></p> <p>Operation <a href="#">getJobsWithStatus</a> in PortType <a href="#">EddsPortType</a></p> <p>Operation <a href="#">getHistoricalLog</a> in PortType <a href="#">EddsPortType</a></p> <p>Operation <a href="#">getTransformations</a> in PortType <a href="#">EddsPortType</a></p> <p>Operation <a href="#">accountRequest</a> in PortType <a href="#">EddsPortType</a></p> <p>Operation <a href="#">getUsers</a> in PortType <a href="#">EddsPortType</a></p> <p>Operation <a href="#">getMissions</a> in PortType <a href="#">EddsPortType</a></p> <p>Operation <a href="#">getMissionsAndDomains</a> in PortType <a href="#">EddsPortType</a></p> <p>Operation <a href="#">getRoles</a> in PortType <a href="#">EddsPortType</a></p> <p>Operation <a href="#">getUserAccountDetails</a> in PortType <a href="#">EddsPortType</a></p> <p>Operation <a href="#">getMissionDetails</a> in PortType <a href="#">EddsPortType</a></p> <p>Operation <a href="#">getUserQuota</a> in PortType <a href="#">EddsPortType</a></p> <p>Operation <a href="#">hasPermissionToSeeAllUsers</a> in PortType <a href="#">EddsPortType</a></p>
source	<pre>&lt;wsdl:message name="authorizationFault"&gt;   &lt;wsdl:documentation&gt;The message contains details related to a authorization   fault&lt;/wsdl:documentation&gt;   &lt;wsdl:part name="authorizationFault" element="model:AuthorizationFault"/&gt; &lt;/wsdl:message&gt;</pre>

### 9.3.5 message batchRequest

*The message contains the details of a batch request*

parts	<p><b>batchRequest</b></p> <p>element <b>model:RequestMessagePart</b></p>
used by	Operation <a href="#">batchRequest</a> in PortType <a href="#">EddsPortType</a>
source	<pre>&lt;wsdl:message name="batchRequest"&gt;   &lt;wsdl:documentation&gt;The message contains the details of a batch   request&lt;/wsdl:documentation&gt;   &lt;wsdl:part name="batchRequest" element="model:RequestMessagePart"/&gt; &lt;/wsdl:message&gt;</pre>

### 9.3.6 message batchRequestResponse

*The message contains job ID associated to a batch request*

parts	<p><b>batchRequestResponse</b></p> <p>element <b>model:JobListIdPart</b></p>
used by	Operation <a href="#">batchRequest</a> in PortType <a href="#">EddsPortType</a>
source	<pre>&lt;wsdl:message name="batchRequestResponse"&gt;   &lt;wsdl:documentation&gt;The message contains job ID associated to a batch</pre>



	<pre>request&lt;/wsdl:documentation&gt; &lt;wsdl:part name="batchRequestResponse" element="model:JobListIdPart"/&gt; &lt;/wsdl:message&gt;</pre>
--	--

### 9.3.7 message cancel

*The message contains the details of "cancel" requests (the job IDs)*

parts	<b>cancel</b> element <b>model:CancelPartList</b>
used by	Operation <a href="#">cancel</a> in PortType <a href="#">EddsPortType</a>
source	<pre>&lt;wsdl:message name="cancel"&gt; &lt;wsdl:documentation&gt;The message contains the details of "cancel" requests (the job IDs)&lt;/wsdl:documentation&gt; &lt;wsdl:part name="cancel" element="model:CancelPartList"/&gt; &lt;/wsdl:message&gt;</pre>

### 9.3.8 message suspend

*The message contains the details of "suspend" request (the job IDs)*

parts	<b>suspend</b> element <b>model:SuspendPartList</b>
used by	Operation <a href="#">suspend</a> in PortType <a href="#">EddsPortType</a>
source	<pre>&lt;wsdl:message name="suspend"&gt; &lt;wsdl:documentation&gt;The message contains the details of "suspend" requests (the job IDs)&lt;/wsdl:documentation&gt; &lt;wsdl:part name="suspend" element="model:SuspendPartList"/&gt; &lt;/wsdl:message&gt;</pre>

### 9.3.9 message resume

*The message contains the details of "resume" requests (the job IDs)*

parts	<b>resume</b> element <b>model:ResumePartList</b>
used by	Operation <a href="#">resume</a> in PortType <a href="#">EddsPortType</a>
source	<pre>&lt;wsdl:message name="resume"&gt; &lt;wsdl:documentation&gt;The message contains the details of "resume" requests (the job IDs)&lt;/wsdl:documentation&gt; &lt;wsdl:part name="resume" element="model:ResumePartList"/&gt; &lt;/wsdl:message&gt;</pre>

### 9.3.10 message cancelResponse

*The message contains the job IDs associated with the cancel requests*

parts	<b>cancelResponse</b> element <b>model:AcknowledgementPartList</b>
used by	Operation <a href="#">cancel</a> in PortType <a href="#">EddsPortType</a>
source	<pre>&lt;wsdl:message name="cancelResponse"&gt;   &lt;wsdl:documentation&gt;The message contains the job IDs associated with the cancel requests&lt;/wsdl:documentation&gt;   &lt;wsdl:part name="cancelResponse" element="model:AcknowledgementPartList"/&gt; &lt;/wsdl:message&gt;</pre>

### 9.3.11 message suspendResponse

*The message contains the job IDs associated with the suspend requests*

parts	<b>suspendResponse</b> element <b>model:AcknowledgementPartList</b>
used by	Operation <a href="#">suspend</a> in PortType <a href="#">EddsPortType</a>
source	<pre>&lt;wsdl:message name="suspendResponse"&gt;   &lt;wsdl:documentation&gt;The message contains the job IDs associated with the suspend requests&lt;/wsdl:documentation&gt;   &lt;wsdl:part name="suspendResponse" element="model:AcknowledgementPartList"/&gt; &lt;/wsdl:message&gt;</pre>

### 9.3.12 message resumeResponse

*The message contains the job IDs associated with the resume requests*

parts	<b>resumeResponse</b> element <b>model:AcknowledgementPartList</b>
used by	Operation <a href="#">resume</a> in PortType <a href="#">EddsPortType</a>
source	<pre>&lt;wsdl:message name="resumeResponse"&gt;   &lt;wsdl:documentation&gt;The message contains the job IDs associated with the resume requests&lt;/wsdl:documentation&gt;   &lt;wsdl:part name="resumeResponse" element="model:AcknowledgementPartList"/&gt; &lt;/wsdl:message&gt;</pre>

### 9.3.13 message checkSession

*Empty message*

parts	
used by	Operation <a href="#">hasSessionExpired</a> in PortType <a href="#">EddsPortType</a>
source	<pre>&lt;wsdl:message name="checkSession"&gt;   &lt;wsdl:documentation&gt;Empty message&lt;/wsdl:documentation&gt; &lt;/wsdl:message&gt;</pre>

### 9.3.14 message checkSessionResponse

*True if session has expired (or not started)*

parts	<b>sessionResponse</b> element <b>model:SessionExpired</b>
used by	Operation <a href="#">hasSessionExpired</a> in PortType <a href="#">EddsPortType</a>
source	<pre>&lt;wsdl:message name="checkSessionResponse"&gt;   &lt;wsdl:documentation&gt;True if session has expired (or not started)&lt;/wsdl:documentation&gt;   &lt;wsdl:part name="sessionResponse" element="model:SessionExpired"/&gt; &lt;/wsdl:message&gt;</pre>

### 9.3.15 message checkUserPassword

*The message contains the password to be verified*

parts	<b>checkUserPassword</b> element <b>model:Password</b>
used by	Operation <a href="#">checkUserPassword</a> in PortType <a href="#">EddsPortType</a>
source	<pre>&lt;wsdl:message name="checkUserPassword"&gt;   &lt;wsdl:documentation&gt;The message contains the password to be   verified&lt;/wsdl:documentation&gt;   &lt;wsdl:part name="checkUserPassword" element="model:Password"/&gt; &lt;/wsdl:message&gt;</pre>

### 9.3.16 message checkUserPasswordResponse

*Empty message*

parts	
used by	Operation <a href="#">checkUserPassword</a> in PortType <a href="#">EddsPortType</a>
source	<pre>&lt;wsdl:message name="checkUserPasswordResponse"&gt;   &lt;wsdl:documentation&gt;Empty message&lt;/wsdl:documentation&gt; &lt;/wsdl:message&gt;</pre>

### 9.3.17 message deleteData

*The message contains the details of a request to delete response data (a job ID)*

parts	<b>deleteData</b> element <b>model&gt;DeleteDataPart</b>
used by	Operation <a href="#">deleteData</a> in PortType <a href="#">EddsPortType</a>
source	<pre>&lt;wsdl:message name="deleteData"&gt;   &lt;wsdl:documentation&gt;The message contains the details of a request to delete response   data (a job ID)&lt;/wsdl:documentation&gt;   &lt;wsdl:part name="deleteData" element="model&gt;DeleteDataPart"/&gt; &lt;/wsdl:message&gt;</pre>

### 9.3.18 message deleteDataResponse

*The message contains the job IDs associated to a request to delete response data*

parts	<b>deleteDataResponse</b> element <b>model:AcknowledgementPartList</b>
used by	Operation <a href="#">deleteData</a> in PortType <a href="#">EddsPortType</a>
source	<pre>&lt;wsdl:message name="deleteDataResponse"&gt;   &lt;wsdl:documentation&gt;The message contains the job IDs associated to a request to delete   response data&lt;/wsdl:documentation&gt;   &lt;wsdl:part name="deleteDataResponse" element="model:AcknowledgementPartList"/&gt; &lt;/wsdl:message&gt;</pre>

### 9.3.19 message deleteRequest

*The message contains the details of a request to delete requests (the job IDs)*

parts	<b>deleteRequest</b> element <b>model&gt;DeleteRequestPart</b>
used by	Operation <a href="#">deleteRequest</a> in PortType <a href="#">EddsPortType</a>
source	<pre>&lt;wsdl:message name="deleteRequest"&gt;   &lt;wsdl:documentation&gt;The message contains the details of a request to delete requests (the   job IDs)&lt;/wsdl:documentation&gt;   &lt;wsdl:part name="deleteRequest" element="model&gt;DeleteRequestPart"/&gt; &lt;/wsdl:message&gt;</pre>

### 9.3.20 message deleteRequestResponse

*The message contains the job IDs associated to the deletion requests*

parts	<b>deleteRequestResponse</b> element <b>model:AcknowledgementPartList</b>
used by	Operation <a href="#">deleteRequest</a> in PortType <a href="#">EddsPortType</a>
source	<pre>&lt;wsdl:message name="deleteRequestResponse"&gt;   &lt;wsdl:documentation&gt;The message contains the job IDs associated to the deletion   requests&lt;/wsdl:documentation&gt;   &lt;wsdl:part name="deleteRequestResponse" element="model:AcknowledgementPartList"/&gt; &lt;/wsdl:message&gt;</pre>

### 9.3.21 message getCatalogue

*Gets the catalogue for the specified data source.*

parts	<b>getCatalogue</b> element <b>model:CatalogueRequest</b>
used by	Operation <a href="#">getCatalogue</a> in PortType <a href="#">EddsPortType</a>
source	<pre>&lt;wsdl:message name="getCatalogue"&gt;</pre>

	<pre>&lt;wsdl:documentation&gt;Gets the catalogue for the specified data source.&lt;/wsdl:documentation&gt; &lt;wsdl:part name="getCatalogue" element="model:CatalogueRequest"/&gt; &lt;/wsdl:message&gt;</pre>
--	---

### 9.3.22 message getCatalogueResponse

Returns the allocated request ID for the request. This is used to take the asynchronous messages off the topic.

parts	<b>catalogueResponse</b> element <b>model:JobIdPart</b>
used by	Operation <a href="#">getCatalogue</a> in PortType <a href="#">EddsPortType</a>
source	<pre>&lt;wsdl:message name="getCatalogueResponse"&gt; &lt;wsdl:documentation&gt;Returns the allocated request ID for the request. This is used to take the asynchronous messages off the topic.&lt;/wsdl:documentation&gt; &lt;wsdl:part name="catalogueResponse" element="model:JobIdPart"/&gt; &lt;/wsdl:message&gt;</pre>

### 9.3.23 message getDataspaces

Gets the list of available dataspaces. For DARC, the first entry in the list is the currently active one.

parts	<b>getDataspaces</b> element <b>model:DataspacesRequest</b>
used by	Operation <a href="#">getDataspaces</a> in PortType <a href="#">EddsPortType</a>
source	<pre>&lt;wsdl:message name="getDataspaces"&gt; &lt;wsdl:documentation&gt;Gets the list of available dataspaces. For DARC, the first entry in the list is the currently active one.&lt;/wsdl:documentation&gt; &lt;wsdl:part name="getDataspaces" element="model:DataspacesRequest"/&gt; &lt;/wsdl:message&gt;</pre>

### 9.3.24 message getDataspacesResponse

Returns the list of available dataspaces. For DARC, the first entry in the list is the currently active one

parts	<b>dataspacesResponse</b> element <b>model:ListString</b>
used by	Operation <a href="#">getDataspaces</a> in PortType <a href="#">EddsPortType</a>
source	<pre>&lt;wsdl:message name="getDataspacesResponse"&gt; &lt;wsdl:documentation&gt;Returns the list of available dataspaces. For DARC, the first entry in the list is the currently active one&lt;/wsdl:documentation&gt; &lt;wsdl:part name="dataspacesResponse" element="model:ListString"/&gt; &lt;/wsdl:message&gt;</pre>

### 9.3.25 message getFarcCatalogue

Gets the FARC catalogue for the specified mission and domain (-1 represents the "No domain").  
 @deprecated use getCatalogue instead

parts	<b>getFarcCatalogue</b> element <b>model:FarcCatalogueRequest</b>
used by	Operation <a href="#">getFarcCatalogue</a> in PortType <a href="#">EddsPortType</a>
source	<pre>&lt;wsdl:message name="getFarcCatalogue"&gt;   &lt;wsdl:documentation&gt;Gets the FARC catalogue for the specified mission and domain (-   1 represents the "No domain").     @deprecated use getCatalogue instead&lt;/wsdl:documentation&gt;   &lt;wsdl:part name="getFarcCatalogue" element="model:FarcCatalogueRequest"/&gt; &lt;/wsdl:message&gt;</pre>

### 9.3.26 message getFarcCatalogueResponse

Returns the allocated request ID for the request. This is used to take the messages off the topic.  
@deprecated

parts	<b>farcCatalogueResponse</b> element <b>model:JobIdPart</b>
used by	Operation <a href="#">getFarcCatalogue</a> in PortType <a href="#">EddsPortType</a>
source	<pre>&lt;wsdl:message name="getFarcCatalogueResponse"&gt;   &lt;wsdl:documentation&gt;Returns the allocated request ID for the request. This is used to   take the messages off the topic.     @deprecated&lt;/wsdl:documentation&gt;   &lt;wsdl:part name="farcCatalogueResponse" element="model:JobIdPart"/&gt; &lt;/wsdl:message&gt;</pre>

### 9.3.27 message getHistoricalLog

The message contains the start and end date to retrieve the historical log from EDDS

parts	<b>getHistoricalLog</b> element <b>model:TimeWindow</b>
used by	Operation <a href="#">getHistoricalLog</a> in PortType <a href="#">EddsPortType</a>
source	<pre>&lt;wsdl:message name="getHistoricalLog"&gt;   &lt;wsdl:documentation&gt;The message contains the start and end date to retrieve the historical   log from EDDS&lt;/wsdl:documentation&gt;   &lt;wsdl:part name="getHistoricalLog" element="model:TimeWindow"/&gt; &lt;/wsdl:message&gt;</pre>

### 9.3.28 message getHistoricalLogResponse

Returns the allocated request ID for the request. This is used to take the messages off the topic.

parts	<b>getHistoricalLogResponse</b> element <b>model:JobIdPart</b>
used by	Operation <a href="#">getHistoricalLog</a> in PortType <a href="#">EddsPortType</a>
source	<pre>&lt;wsdl:message name="getHistoricalLogResponse"&gt;   &lt;wsdl:documentation&gt;Returns the allocated request ID for the request. This is used to take   the messages off the topic.&lt;/wsdl:documentation&gt;</pre>

	<pre>&lt;wsdl:part name="getHistoricalLogResponse" element="model:JobIdPart"/&gt; &lt;/wsdl:message&gt;</pre>
--	---

### 9.3.29 message getJobs

*The message contains the start and end date to retrieve the jobs from EDDS*

parts	<b>getJobs</b> element <b>model:TimeWindow</b>
used by	Operation <a href="#">getJobs</a> in PortType <a href="#">EddsPortType</a> Operation <a href="#">getJobsWithStatus</a> in PortType <a href="#">EddsPortType</a>
source	<pre>&lt;wsdl:message name="getJobs"&gt;   &lt;wsdl:documentation&gt;The message contains the start and end date to retrieve the jobs from EDDS&lt;/wsdl:documentation&gt;   &lt;wsdl:part name="getJobs" element="model:TimeWindow"/&gt; &lt;/wsdl:message&gt;</pre>

### 9.3.30 message getJobsResponse

*The list of jobs*

parts	<b>getJobsResponse</b> element <b>model:JobListIdPart</b>
used by	Operation <a href="#">getJobs</a> in PortType <a href="#">EddsPortType</a>
source	<pre>&lt;wsdl:message name="getJobsResponse"&gt;   &lt;wsdl:documentation&gt;The list of jobs&lt;/wsdl:documentation&gt;   &lt;wsdl:part name="getJobsResponse" element="model:JobListIdPart"/&gt; &lt;/wsdl:message&gt;</pre>

### 9.3.31 message getJobsWithStatus

*The message contains the start and end date to retrieve the jobs from EDDS*

parts	<b>getJobsWithStatus</b> element <b>model:TimeWindow</b>
source	<pre>&lt;wsdl:message name="getJobsWithStatus"&gt;   &lt;wsdl:documentation&gt;The message contains the start and end date to retrieve the jobs from EDDS&lt;/wsdl:documentation&gt;   &lt;wsdl:part name="getJobsWithStatus" element="model:TimeWindow"/&gt; &lt;/wsdl:message&gt;</pre>

### 9.3.32 message getJobsWithStatusResponse

*Returns the allocated unique ID for the request. This is used to take the messages off the topic. The ID is a random string, not a Request ID.*

parts	<b>getJobsWithStatusResponse</b> element <b>model:JobIdPart</b>
-------	--

used by	Operation <a href="#">getJobsWithStatus</a> in PortType <a href="#">EddsPortType</a>
source	<pre>&lt;wsdl:message name="getJobsWithStatusResponse"&gt;   &lt;wsdl:documentation&gt;Returns the allocated unique ID for the request. This is used to take   the messages off the topic. The ID is a random string, not a Request   ID.&lt;/wsdl:documentation&gt;   &lt;wsdl:part name="getJobsWithStatusResponse" element="model:JobIdPart"/&gt; &lt;/wsdl:message&gt;</pre>

### 9.3.33 message getMissionDetails

*The message contains a mission's name*

parts	<b>getMissionDetails</b> element <b>model:MissionName</b>
used by	Operation <a href="#">getMissionDetails</a> in PortType <a href="#">EddsPortType</a>
source	<pre>&lt;wsdl:message name="getMissionDetails"&gt;   &lt;wsdl:documentation&gt;The message contains a mission's name&lt;/wsdl:documentation&gt;   &lt;wsdl:part name="getMissionDetails" element="model:MissionName"/&gt; &lt;/wsdl:message&gt;</pre>

### 9.3.34 message getMissionDetailsResponse

*The message contains the missions details associated to the mission's name as defined in the LDAP*

parts	<b>getMissionDetailsResponse</b> element <b>model:MissionDetails</b>
used by	Operation <a href="#">getMissionDetails</a> in PortType <a href="#">EddsPortType</a>
source	<pre>&lt;wsdl:message name="getMissionDetailsResponse"&gt;   &lt;wsdl:documentation&gt;The message contains the missions details associated to the   mission's name as defined in the LDAP&lt;/wsdl:documentation&gt;   &lt;wsdl:part name="getMissionDetailsResponse" element="model:MissionDetails"/&gt; &lt;/wsdl:message&gt;</pre>

### 9.3.35 message getMissions

*Empty message*

parts	
used by	Operation <a href="#">getMissions</a> in PortType <a href="#">EddsPortType</a>
source	<pre>&lt;wsdl:message name="getMissions"&gt;   &lt;wsdl:documentation&gt;Empty message&lt;/wsdl:documentation&gt; &lt;/wsdl:message&gt;</pre>



### 9.3.36 message getMissionsResponse

*The list of missions*

parts	<b>getMissionsResponse</b> element <b>model:MissionsList</b>
used by	Operation <a href="#">getMissions</a> in PortType <a href="#">EddsPortType</a>
source	<pre>&lt;wsdl:message name="getMissionsResponse"&gt;   &lt;wsdl:documentation&gt;The list of missions&lt;/wsdl:documentation&gt;   &lt;wsdl:part name="getMissionsResponse" element="model:MissionsList"/&gt; &lt;/wsdl:message&gt;</pre>

### 9.3.37 message getMissionsAndDomains

*Empty message*

parts	
used by	Operation <a href="#">getMissionsAndDomains</a> in PortType <a href="#">EddsPortType</a>
source	<pre>&lt;wsdl:message name="getMissionsAndDomains"&gt;   &lt;wsdl:documentation&gt;Empty message&lt;/wsdl:documentation&gt; &lt;/wsdl:message&gt;</pre>

### 9.3.38 message getMissionsAndDomainsResponse

*The list of missions with their domains*

parts	<b>getMissionsAndDomainsResponse</b> element <b>model:MissionsDomainList</b>
used by	Operation <a href="#">getMissionsAndDomains</a> in PortType <a href="#">EddsPortType</a>
source	<pre>&lt;wsdl:message name="getMissionsAndDomainsResponse"&gt;   &lt;wsdl:documentation&gt;The list of missions with their domains&lt;/wsdl:documentation&gt;   &lt;wsdl:part name="getMissionsAndDomainsResponse"   element="model:MissionsDomainList"/&gt; &lt;/wsdl:message&gt;</pre>

### 9.3.39 message getParamDefinitions

*Gets the parameter definitions for the specified mission.*

parts	<b>getParamDefinitions</b> element <b>model:MissionName</b>
used by	Operation <a href="#">getParamDefinitions</a> in PortType <a href="#">EddsPortType</a>
source	<pre>&lt;wsdl:message name="getParamDefinitions"&gt;   &lt;wsdl:documentation&gt;Gets the parameter definitions for the specified   mission.&lt;/wsdl:documentation&gt;   &lt;wsdl:part name="getParamDefinitions" element="model:MissionName"/&gt; &lt;/wsdl:message&gt;</pre>

### 9.3.40 message getParamDefinitionsResponse

Returns the allocated request ID for the request. This is used to take the messages off the topic.

parts	<b>paramDefinitionsResponse</b> element <b>model:JobIdPart</b>
used by	Operation <a href="#">getParamDefinitions</a> in PortType <a href="#">EddsPortType</a>
source	<pre>&lt;wsdl:message name="getParamDefinitionsResponse"&gt;   &lt;wsdl:documentation&gt;Returns the allocated request ID for the request. This is used to take the messages off the topic.&lt;/wsdl:documentation&gt;   &lt;wsdl:part name="paramDefinitionsResponse" element="model:JobIdPart"/&gt; &lt;/wsdl:message&gt;</pre>

### 9.3.41 message getRequest

The message contains the details of a "request" request (a job ID)

parts	<b>getRequest</b> element <b>model:JobIdPart</b>
used by	Operation <a href="#">getRequest</a> in PortType <a href="#">EddsPortType</a>
source	<pre>&lt;wsdl:message name="getRequest"&gt;   &lt;wsdl:documentation&gt;The message contains the details of a "request" request (a job ID)&lt;/wsdl:documentation&gt;   &lt;wsdl:part name="getRequest" element="model:JobIdPart"/&gt; &lt;/wsdl:message&gt;</pre>

### 9.3.42 message getRequestResponse

The message contains the original request associated to the given job ID

parts	<b>getRequestResponse</b> element <b>model:RequestMessagePart</b>
used by	Operation <a href="#">getRequest</a> in PortType <a href="#">EddsPortType</a>
source	<pre>&lt;wsdl:message name="getRequestResponse"&gt;   &lt;wsdl:documentation&gt;The message contains the original request associated to the given job ID&lt;/wsdl:documentation&gt;   &lt;wsdl:part name="getRequestResponse" element="model:RequestMessagePart"/&gt; &lt;/wsdl:message&gt;</pre>

### 9.3.43 message getResponse

The message contains the details of a "response" request (a job ID)

parts	<b>getResponse</b> element <b>model:DownloadList</b>
used by	Operation <a href="#">getResponse</a> in PortType <a href="#">EddsPortType</a>
source	<pre>&lt;wsdl:message name="getResponse"&gt;</pre>

	<pre>&lt;wsdl:documentation&gt; Get the response file(s) for a request. If the file list is empty, all response files are returned.&lt;/wsdl:documentation&gt; &lt;wsdl:part name="getResponse" element="model:DownloadList"/&gt; &lt;/wsdl:message&gt;</pre>
--	---

### 9.3.44 message getResponseResponse

*The message contains the response file associated to a specific request*

parts	<b>getResponseResponse</b> element <b>model:ResponseData</b>
used by	Operation <a href="#">getResponse</a> in PortType <a href="#">EddsPortType</a>
source	<pre>&lt;wsdl:message name="getResponseResponse"&gt; &lt;wsdl:documentation&gt;The message contains the response file associated to a specific request&lt;/wsdl:documentation&gt; &lt;wsdl:part name="getResponseResponse" element="model:ResponseData"/&gt; &lt;/wsdl:message&gt;</pre>

### 9.3.45 message getRoles

*The message contains the name of the mission to get the roles for*

parts	<b>getRoles</b> element <b>model:MissionName</b>
used by	Operation <a href="#">getRoles</a> in PortType <a href="#">EddsPortType</a>
source	<pre>&lt;wsdl:message name="getRoles"&gt; &lt;wsdl:documentation&gt;The message contains the name of the mission to get the roles for&lt;/wsdl:documentation&gt; &lt;wsdl:part name="getRoles" element="model:MissionName"/&gt; &lt;/wsdl:message&gt;</pre>

### 9.3.46 message getRolesResponse

*The list of roles for the specified mission*

parts	<b>getRolesResponse</b> element <b>model:RolesList</b>
used by	Operation <a href="#">getRoles</a> in PortType <a href="#">EddsPortType</a>
source	<pre>&lt;wsdl:message name="getRolesResponse"&gt; &lt;wsdl:documentation&gt;The list of roles for the specified mission&lt;/wsdl:documentation&gt; &lt;wsdl:part name="getRolesResponse" element="model:RolesList"/&gt; &lt;/wsdl:message&gt;</pre>

### 9.3.47 message getStatus

*The message contains the details of a "status" request (a job ID)*

parts	<b>getStatus</b>
-------	------------------

	element <b>model:JobIdPart</b>
used by	Operation <a href="#">getStatus</a> in PortType <a href="#">EddsPortType</a>
source	<pre>&lt;wsdl:message name="getStatus"&gt;   &lt;wsdl:documentation&gt;The message contains the details of a "status" request (a job ID)&lt;/wsdl:documentation&gt;   &lt;wsdl:part name="getStatus" element="model:JobIdPart"/&gt; &lt;/wsdl:message&gt;</pre>

### 9.3.48 message getStatuses

*Gets the status of a list of jobs*

parts	<b>getStatus</b> element <b>model:JobListIdPart</b>
used by	Operation <a href="#">getStatuses</a> in PortType <a href="#">EddsPortType</a>
source	<pre>&lt;wsdl:message name="getStatuses"&gt;   &lt;wsdl:documentation&gt;Gets the status of a list of jobs&lt;/wsdl:documentation&gt;   &lt;wsdl:part name="getStatus" element="model:JobListIdPart"/&gt; &lt;/wsdl:message&gt;</pre>

### 9.3.49 message getStatusesResponse

*Returns the allocated unique ID for the request. This is used to take the messages off the topic. The ID is a random string, not a Request ID.*

parts	<b>getStatusesResponse</b> element <b>model:JobIdPart</b>
used by	Operation <a href="#">getStatuses</a> in PortType <a href="#">EddsPortType</a>
source	<pre>&lt;wsdl:message name="getStatusesResponse"&gt;   &lt;wsdl:documentation&gt;Returns the allocated unique ID for the request. This is used to take the messages off the topic. The ID is a random string, not a Request ID.&lt;/wsdl:documentation&gt;   &lt;wsdl:part name="getStatusesResponse" element="model:JobIdPart"/&gt; &lt;/wsdl:message&gt;</pre>

### 9.3.50 message getStatusResponse

*The message contains the acknowledgement of a specific request*

parts	<b>getStatusResponse</b> element <b>model:AcknowledgementPart</b>
used by	Operation <a href="#">getStatus</a> in PortType <a href="#">EddsPortType</a>
source	<pre>&lt;wsdl:message name="getStatusResponse"&gt;   &lt;wsdl:documentation&gt;The message contains the acknowledgement of a specific request&lt;/wsdl:documentation&gt;   &lt;wsdl:part name="getStatusResponse" element="model:AcknowledgementPart"/&gt; &lt;/wsdl:message&gt;</pre>

### 9.3.51 message getTransformations

*The message contains the mission name and request type*

parts	<b>getTransformations</b> element <b>model:TransformationsRequest</b>
used by	Operation <a href="#">getTransformations</a> in PortType <a href="#">EddsPortType</a>
source	<pre>&lt;wsdl:message name="getTransformations"&gt;   &lt;wsdl:documentation&gt;The message contains the mission name and request   type&lt;/wsdl:documentation&gt;   &lt;wsdl:part name="getTransformations" element="model:TransformationsRequest"/&gt; &lt;/wsdl:message&gt;</pre>

### 9.3.52 message getTransformationsResponse

*The message contains a list of available transformations*

parts	<b>getTransformationsResponse</b> element <b>model:TransformationsList</b>
used by	Operation <a href="#">getTransformations</a> in PortType <a href="#">EddsPortType</a>
source	<pre>&lt;wsdl:message name="getTransformationsResponse"&gt;   &lt;wsdl:documentation&gt;The message contains a list of available   transformations&lt;/wsdl:documentation&gt;   &lt;wsdl:part name="getTransformationsResponse" element="model:TransformationsList"/&gt; &lt;/wsdl:message&gt;</pre>

### 9.3.53 message getUserAccountDetails

*The message contains a username*

parts	<b>getUserAccountDetails</b> element <b>model:UserName</b>
used by	Operation <a href="#">getUserAccountDetails</a> in PortType <a href="#">EddsPortType</a>
source	<pre>&lt;wsdl:message name="getUserAccountDetails"&gt;   &lt;wsdl:documentation&gt;The message contains a username&lt;/wsdl:documentation&gt;   &lt;wsdl:part name="getUserAccountDetails" element="model:UserName"/&gt; &lt;/wsdl:message&gt;</pre>

### 9.3.54 message getUserAccountDetailsResponse

*The message contains the user details associated to the username as defined in the LDAP*

parts	<b>getUserAccountDetailsResponse</b> element <b>model:UserAccountDetails</b>
used by	Operation <a href="#">getUserAccountDetails</a> in PortType <a href="#">EddsPortType</a>
source	<pre>&lt;wsdl:message name="getUserAccountDetailsResponse"&gt;   &lt;wsdl:documentation&gt;The message contains the user details associated to the username as</pre>

	defined in the LDAP</wsl:documentation> <wsl:part name="getUserAccountDetailsResponse" element="model:UserAccountDetails"/> </wsl:message>
--	---

### 9.3.55 message getUserQuota

*The message contains a mission's name*

parts	<b>getUserQuota</b> element <b>model:MissionName</b>
used by	Operation <a href="#">getUserQuota</a> in PortType <a href="#">EddsPortType</a>
source	<wsl:message name="getUserQuota"> <wsl:documentation>The message contains a mission's name</wsl:documentation> <wsl:part name="getUserQuota" element="model:MissionName"/> </wsl:message>

### 9.3.56 message getUserQuotaResponse

*The message contains the user quota usage details*

parts	<b>getUserQuotaResponse</b> element <b>model:UserQuotaDetails</b>
used by	Operation <a href="#">getUserQuota</a> in PortType <a href="#">EddsPortType</a>
source	<wsl:message name="getUserQuotaResponse"> <wsl:documentation>The message contains the user quota usage details</wsl:documentation> <wsl:part name="getUserQuotaResponse" element="model:UserQuotaDetails"/> </wsl:message>

### 9.3.57 message getUsers

*Flag to indicate whether to fetch all users or not*

parts	<b>getUsers</b> element <b>model:IncludeAll</b>
used by	Operation <a href="#">getUsers</a> in PortType <a href="#">EddsPortType</a>
source	<wsl:message name="getUsers"> <wsl:documentation>Flag to indicate whether to fetch all users or not</wsl:documentation> <wsl:part name="getUsers" element="model:IncludeAll"/> </wsl:message>

### 9.3.58 message getUsersResponse

*The list of users*

parts	<b>getUsersResponse</b>
-------	-------------------------

	element <b>model:UsersList</b>
used by	Operation <a href="#">getUsers</a> in PortType <a href="#">EddsPortType</a>
source	<pre>&lt;wsdl:message name="getUsersResponse"&gt;   &lt;wsdl:documentation&gt;The list of users&lt;/wsdl:documentation&gt;   &lt;wsdl:part name="getUsersResponse" element="model:UsersList"/&gt; &lt;/wsdl:message&gt;</pre>

### 9.3.59 message hasPermissionToSeeAllUsers

*The message contains a username*

parts	<b>hasPermissionToSeeAllUsers</b> element <b>model:UserName</b>
used by	Operation <a href="#">hasPermissionToSeeAllUsers</a> in PortType <a href="#">EddsPortType</a>
source	<pre>&lt;wsdl:message name="hasPermissionToSeeAllUsers"&gt;   &lt;wsdl:documentation&gt;The message contains a username&lt;/wsdl:documentation&gt;   &lt;wsdl:part name="hasPermissionToSeeAllUsers" element="model:UserName"/&gt; &lt;/wsdl:message&gt;</pre>

### 9.3.60 message logIn

*The message contains the user credentials needed for the authentication*

parts	<b>credentials</b> element <b>model:UserCredentials</b>
used by	Operation <a href="#">logIn</a> in PortType <a href="#">EddsPortType</a>
source	<pre>&lt;wsdl:message name="logIn"&gt;   &lt;wsdl:documentation&gt;The message contains the user credentials needed for the authentication&lt;/wsdl:documentation&gt;   &lt;wsdl:part name="credentials" element="model:UserCredentials"/&gt; &lt;/wsdl:message&gt;</pre>

### 9.3.61 message logInResponse

*The message returns the user credentials enriched with the session ID*

parts	<b>credentials</b> element <b>model:UserCredentials</b>
used by	Operation <a href="#">logIn</a> in PortType <a href="#">EddsPortType</a>
source	<pre>&lt;wsdl:message name="logInResponse"&gt;   &lt;wsdl:documentation&gt;The message returns the user credentials enriched with the session ID&lt;/wsdl:documentation&gt;   &lt;wsdl:part name="credentials" element="model:UserCredentials"/&gt; &lt;/wsdl:message&gt;</pre>

### 9.3.62 message logOut

*Empty message*

parts	
used by	Operation <a href="#">logOut</a> in PortType <a href="#">EddsPortType</a>
source	<pre>&lt;wsdl:message name="logOut"&gt;   &lt;wsdl:documentation&gt;Empty message&lt;/wsdl:documentation&gt; &lt;/wsdl:message&gt;</pre>

### 9.3.63 message passwordExpiredFault

*The message contains details related to a authentication fault*

parts	<b>passwordExpiredFault</b> element <b>model:PasswordExpiredFault</b>
used by	Operation <a href="#">logIn</a> in PortType <a href="#">EddsPortType</a>
source	<pre>&lt;wsdl:message name="passwordExpiredFault"&gt;   &lt;wsdl:documentation&gt;The message contains details related to a authentication   fault&lt;/wsdl:documentation&gt;   &lt;wsdl:part name="passwordExpiredFault" element="model:PasswordExpiredFault"/&gt; &lt;/wsdl:message&gt;</pre>

### 9.3.64 message permissionToSeeAllUsersResponse

*True if session has expired (or not started)*

parts	<b>permissionToSeeAllUsersResponse</b> element <b>model:PermissionToSeeAllUsers</b>
used by	Operation <a href="#">hasPermissionToSeeAllUsers</a> in PortType <a href="#">EddsPortType</a>
source	<pre>&lt;wsdl:message name="permissionToSeeAllUsersResponse"&gt;   &lt;wsdl:documentation&gt;True if session has expired (or not started)&lt;/wsdl:documentation&gt;   &lt;wsdl:part name="permissionToSeeAllUsersResponse"   element="model:PermissionToSeeAllUsers"/&gt; &lt;/wsdl:message&gt;</pre>

### 9.3.65 message requestFault

*The message contains details related to a request fault*

parts	<b>requestFault</b> element <b>model:RequestFault</b>
used by	Operation <a href="#">batchRequest</a> in PortType <a href="#">EddsPortType</a> Operation <a href="#">streamRequest</a> in PortType <a href="#">EddsPortType</a> Operation <a href="#">getStatus</a> in PortType <a href="#">EddsPortType</a> Operation <a href="#">getStatuses</a> in PortType <a href="#">EddsPortType</a> Operation <a href="#">getResponse</a> in PortType <a href="#">EddsPortType</a> Operation <a href="#">getRequest</a> in PortType <a href="#">EddsPortType</a>



	<p>Operation <a href="#">getStreamRequest</a> in PortType <a href="#">EddsPortType</a></p> <p>Operation <a href="#">startStreamData</a> in PortType <a href="#">EddsPortType</a></p> <p>Operation <a href="#">getParamDefinitions</a> in PortType <a href="#">EddsPortType</a></p> <p>Operation <a href="#">getFarcCatalogue</a> in PortType <a href="#">EddsPortType</a></p> <p>Operation <a href="#">cancel</a> in PortType <a href="#">EddsPortType</a></p> <p>Operation <a href="#">suspend</a> in PortType <a href="#">EddsPortType</a></p> <p>Operation <a href="#">resume</a> in PortType <a href="#">EddsPortType</a></p> <p>Operation <a href="#">deleteData</a> in PortType <a href="#">EddsPortType</a></p> <p>Operation <a href="#">deleteRequest</a> in PortType <a href="#">EddsPortType</a></p> <p>Operation <a href="#">getJobs</a> in PortType <a href="#">EddsPortType</a></p> <p>Operation <a href="#">getJobsWithStatus</a> in PortType <a href="#">EddsPortType</a></p> <p>Operation <a href="#">getHistoricalLog</a> in PortType <a href="#">EddsPortType</a></p> <p>Operation <a href="#">getTransformations</a> in PortType <a href="#">EddsPortType</a></p> <p>Operation <a href="#">accountRequest</a> in PortType <a href="#">EddsPortType</a></p> <p>Operation <a href="#">getUsers</a> in PortType <a href="#">EddsPortType</a></p> <p>Operation <a href="#">getMissions</a> in PortType <a href="#">EddsPortType</a></p> <p>Operation <a href="#">getMissionsAndDomains</a> in PortType <a href="#">EddsPortType</a></p> <p>Operation <a href="#">getRoles</a> in PortType <a href="#">EddsPortType</a></p> <p>Operation <a href="#">getUserAccountDetails</a> in PortType <a href="#">EddsPortType</a></p> <p>Operation <a href="#">getMissionDetails</a> in PortType <a href="#">EddsPortType</a></p> <p>Operation <a href="#">getUserQuota</a> in PortType <a href="#">EddsPortType</a></p> <p>Operation <a href="#">hasPermissionToSeeAllUsers</a> in PortType <a href="#">EddsPortType</a></p>
source	<pre>&lt;wsdl:message name="requestFault"&gt;   &lt;wsdl:documentation&gt;The message contains details related to a request   fault&lt;/wsdl:documentation&gt;   &lt;wsdl:part name="requestFault" element="model:RequestFault"/&gt; &lt;/wsdl:message&gt;</pre>

### 9.3.66 message reSubmit

*The message contains the details of a request to re-submit(a job ID)*

parts	<p><b>reSubmit</b></p> <p>element <b>model:JobIdPart</b></p>
source	<pre>&lt;wsdl:message name="reSubmit"&gt;   &lt;wsdl:documentation&gt;The message contains the details of a request to re-submit(a job   ID)&lt;/wsdl:documentation&gt;   &lt;wsdl:part name="reSubmit" element="model:JobIdPart"/&gt; &lt;/wsdl:message&gt;</pre>

### 9.3.67 message reSubmitResponse

*The message contains job IDs associated to a batch request*

parts	<p><b>reSubmitResponse</b></p> <p>element <b>model:JobListIdPart</b></p>
source	<pre>&lt;wsdl:message name="reSubmitResponse"&gt;   &lt;wsdl:documentation&gt;The message contains job IDs associated to a batch   request&lt;/wsdl:documentation&gt;   &lt;wsdl:part name="reSubmitResponse" element="model:JobListIdPart"/&gt; &lt;/wsdl:message&gt;</pre>

### 9.3.68 message sessionFault

*The message contains details related to a session fault*

parts	<b>sessionFault</b> element <b>model:SessionFault</b>
used by	Operation <a href="#">batchRequest</a> in PortType <a href="#">EddsPortType</a> Operation <a href="#">streamRequest</a> in PortType <a href="#">EddsPortType</a> Operation <a href="#">getStatus</a> in PortType <a href="#">EddsPortType</a> Operation <a href="#">getStatuses</a> in PortType <a href="#">EddsPortType</a> Operation <a href="#">getResponse</a> in PortType <a href="#">EddsPortType</a> Operation <a href="#">getRequest</a> in PortType <a href="#">EddsPortType</a> Operation <a href="#">getStreamRequest</a> in PortType <a href="#">EddsPortType</a> Operation <a href="#">startStreamData</a> in PortType <a href="#">EddsPortType</a> Operation <a href="#">stopStreamData</a> in PortType <a href="#">EddsPortType</a> Operation <a href="#">getParamDefinitions</a> in PortType <a href="#">EddsPortType</a> Operation <a href="#">getFarcCatalogue</a> in PortType <a href="#">EddsPortType</a> Operation <a href="#">cancel</a> in PortType <a href="#">EddsPortType</a> Operation <a href="#">suspend</a> in PortType <a href="#">EddsPortType</a> Operation <a href="#">resume</a> in PortType <a href="#">EddsPortType</a> Operation <a href="#">deleteData</a> in PortType <a href="#">EddsPortType</a> Operation <a href="#">deleteRequest</a> in PortType <a href="#">EddsPortType</a> Operation <a href="#">getJobs</a> in PortType <a href="#">EddsPortType</a> Operation <a href="#">getJobsWithStatus</a> in PortType <a href="#">EddsPortType</a> Operation <a href="#">getHistoricalLog</a> in PortType <a href="#">EddsPortType</a> Operation <a href="#">getTransformations</a> in PortType <a href="#">EddsPortType</a> Operation <a href="#">checkUserPassword</a> in PortType <a href="#">EddsPortType</a> Operation <a href="#">accountRequest</a> in PortType <a href="#">EddsPortType</a> Operation <a href="#">getUsers</a> in PortType <a href="#">EddsPortType</a> Operation <a href="#">getMissions</a> in PortType <a href="#">EddsPortType</a> Operation <a href="#">getMissionsAndDomains</a> in PortType <a href="#">EddsPortType</a> Operation <a href="#">getRoles</a> in PortType <a href="#">EddsPortType</a> Operation <a href="#">getUserAccountDetails</a> in PortType <a href="#">EddsPortType</a> Operation <a href="#">getMissionDetails</a> in PortType <a href="#">EddsPortType</a> Operation <a href="#">getUserQuota</a> in PortType <a href="#">EddsPortType</a> Operation <a href="#">hasPermissionToSeeAllUsers</a> in PortType <a href="#">EddsPortType</a>
source	<pre> &lt;wsdl:message name="sessionFault"&gt;   &lt;wsdl:documentation&gt;The message contains details related to a session   fault&lt;/wsdl:documentation&gt;   &lt;wsdl:part name="sessionFault" element="model:SessionFault"/&gt; &lt;/wsdl:message&gt; </pre>

### 9.3.69 message streamRequest

*The message contains the details of a stream request*

parts	<b>streamRequest</b> element <b>model:StreamRequestMessagePart</b>
used by	Operation <a href="#">streamRequest</a> in PortType <a href="#">EddsPortType</a>
source	<pre> &lt;wsdl:message name="streamRequest"&gt;   &lt;wsdl:documentation&gt;The message contains the details of a stream   request&lt;/wsdl:documentation&gt;   &lt;wsdl:part name="streamRequest" element="model:StreamRequestMessagePart"/&gt; &lt;/wsdl:message&gt; </pre>

### 9.3.70 message streamRequestResponse

*The message contains job ID associated to a stream request*

parts	<b>streamRequestResponse</b> element <b>model:JobIdPart</b>
used by	Operation <a href="#">streamRequest</a> in PortType <a href="#">EddsPortType</a>
source	<pre>&lt;wsdl:message name="streamRequestResponse"&gt;   &lt;wsdl:documentation&gt;The message contains job ID associated to a stream   request&lt;/wsdl:documentation&gt;   &lt;wsdl:part name="streamRequestResponse" element="model:JobIdPart"/&gt; &lt;/wsdl:message&gt;</pre>

### 9.3.71 message startStreamData

*Starts the incoming stream of the specified active stream request to the client.*

parts	<b>startStreamData</b> element <b>model:JobIdPart</b>
used by	Operation <a href="#">startStreamData</a> in PortType <a href="#">EddsPortType</a>
source	<pre>&lt;wsdl:message name="startStreamData"&gt;   &lt;wsdl:documentation&gt;Starts the incoming stream of the specified active stream request to   the client.&lt;/wsdl:documentation&gt;   &lt;wsdl:part name="startStreamData" element="model:JobIdPart"/&gt; &lt;/wsdl:message&gt;</pre>

### 9.3.72 message startStreamDataResponse

*Empty message*

parts	
used by	Operation <a href="#">startStreamData</a> in PortType <a href="#">EddsPortType</a>
source	<pre>&lt;wsdl:message name="startStreamDataResponse"&gt;   &lt;wsdl:documentation&gt;Empty message&lt;/wsdl:documentation&gt; &lt;/wsdl:message&gt;</pre>

### 9.3.73 message stopStreamData

*Stops the incoming stream of the specified active stream request to the client.*

parts	<b>stopStreamData</b> element <b>model:JobIdPart</b>
used by	Operation <a href="#">stopStreamData</a> in PortType <a href="#">EddsPortType</a>
source	<pre>&lt;wsdl:message name="stopStreamData"&gt;   &lt;wsdl:documentation&gt;Stops the incoming stream of the specified active stream request to   the client.&lt;/wsdl:documentation&gt;   &lt;wsdl:part name="stopStreamData" element="model:JobIdPart"/&gt; &lt;/wsdl:message&gt;</pre>

### 9.3.74 message stopStreamDataResponse

Empty message

parts	
used by	Operation <a href="#">stopStreamData</a> in PortType <a href="#">EddsPortType</a>
source	<pre>&lt;wsdl:message name="stopStreamDataResponse"&gt;   &lt;wsdl:documentation&gt;Empty message&lt;/wsdl:documentation&gt; &lt;/wsdl:message&gt;</pre>

## 9.4 Bindings

The EDDS binding describes how the service is bound to the messaging protocol. Note that this EUICD assumes the use of SOAP as the underlying protocol for all services.

type	<a href="#">ws:EddsPortType</a>
extensibility	<pre>&lt;soap:binding style="document" transport="http://schemas.xmlsoap.org/soap/http"/&gt;</pre>
operations	<p><b>batchRequest</b></p> <p><i>This operation perform a batch request on the EDDS ever. The request is asynchronous and its output is the job ID or an error in case of failure</i></p> <p>extensibility <pre>&lt;soap:operation   soapAction="http://edds.egos.esa/batchrequest/batchRequest"   style="document"/&gt;</pre></p> <p>input name="batchRequest" <pre>&lt;soap:body use="literal"/&gt;</pre></p> <p>output name="batchRequestResponse" <pre>&lt;soap:body use="literal"/&gt;</pre></p> <p><b>streamRequest</b></p> <p><i>This operation perform a stream request on the EDDS ever. The request is asynchronous and its output is the job ID or an error in case of failure</i></p> <p>extensibility <pre>&lt;soap:operation   soapAction="http://edds.egos.esa/streamrequest/streamRequest"   style="document"/&gt;</pre></p> <p>input name="streamRequest" <pre>&lt;soap:body use="literal"/&gt;</pre></p> <p>output name="streamRequestResponse" <pre>&lt;soap:body use="literal"/&gt;</pre></p> <p><b>getStatus</b></p> <p><i>This operation provides the status of a specific request. The operation takes as input a job ID and return an acknowledgement</i></p> <p>extensibility <pre>&lt;soap:operation   soapAction="http://edds.egos.esa/batchrequest/getStatus"   style="document"/&gt;</pre></p> <p>input name="getStatus" <pre>&lt;soap:body use="literal"/&gt;</pre></p> <p>output name="getStatusResponse" <pre>&lt;soap:body use="literal"/&gt;</pre></p> <p><b>reSubmit</b></p> <p><i>This operation re-submits a request. The operation takes as input a job ID and its output is the list of job IDs</i></p> <p>extensibility <pre>&lt;soap:operation soapAction="http://edds.egos.esa/batchrequest/reSubmit"</pre></p>

```

    bility style="document"/>
    input name="reSubmit"<soap:body use="literal"/>
    output name="reSubmitResponse"<soap:body use="literal"/>

```

### getStatuses

*Gets the status of a list of jobs. The operation takes as input a list of job IDs and returns a java.util.ArrayList of type RequestInfoRec encoded in Base64*

```

    extiensi <soap:operation
    bility soapAction="http://edds.egos.esa/batchrequest/getStatuses"
    style="document"/>
    input name="getStatuses"<soap:body use="literal"/>
    output name="getStatusesResponse"<soap:body use="literal"/>

```

### getResponse

*This operation returns the result file of a batch request. The response is available if the delivery method of the associated batch request was "server delivery". The method is synchronous.*

```

    extiensi <soap:operation
    bility soapAction="http://edds.egos.esa/batchrequest/getResponse"
    style="document"/>
    input name="getResponse"<soap:body use="literal"/>
    output name="getResponseResponse"<soap:body use="literal"/>

```

### getRequest

*This operation provides the template of an existing batch request. The operation takes in input the batch request job ID and returns as output the corresponding XML. The method is synchronous.*

```

    extiensi <soap:operation
    bility soapAction="http://edds.egos.esa/batchrequest/getRequest"
    style="document"/>
    input name="getRequest"<soap:body use="literal"/>
    output name="getRequestResponse"<soap:body use="literal"/>

```

### getStreamRequest

*This operation provides the template of an existing batch request. The operation takes in input the batch request job ID and returns as output the corresponding XML. The method is synchronous.*

```

    extiensi <soap:operation
    bility soapAction="http://edds.egos.esa/streamrequest/getStreamRequest"
    style="document"/>
    input name="getStreamRequest"<soap:body use="literal"/>
    output name="getStreamRequestResponse"<soap:body use="literal"/>

```

### startStreamData

*Starts the CometD forwarder of the specified stream request*

```

    extiensi <soap:operation
    bility soapAction="http://edds.egos.esa/streamrequest/startStreamData"
    style="document"/>
    input name="startStreamData"<soap:body use="literal"/>
    output name="startStreamDataResponse"<soap:body use="literal"/>

```

### stopStreamData

*Stops the CometD forwarder of the specified stream request*

```

extensibility <soap:operation
  soapAction="http://edds.egos.esa/streamrequest/stopStreamData"
  style="document"/>
input name="stopStreamData" <soap:body use="literal"/>
output name="stopStreamDataResponse" <soap:body use="literal"/>

```

### getParamDefinitions

*Gets the parameter definitions for the specified mission. The method is synchronous.*

```

extensibility <soap:operation
  soapAction="http://edds.egos.esa/batchrequest/getParamDefinitions"
  style="document"/>
input name="getParamDefinitions" <soap:body use="literal"/>
output name="getParamDefinitionsResponse" <soap:body use="literal"/>

```

### getCatalogue

*Gets the catalogue for the specified data source. The method is asynchronous.*

```

extensibility <soap:operation
  soapAction="http://edds.egos.esa/batchrequest/getCatalogue"
  style="document"/>
input name="getCatalogue" <soap:body use="literal"/>
output name="getCatalogueResponse" <soap:body use="literal"/>

```

### getFarcCatalogue

*Gets the FARC catalogue for the specified mission and domain. The method is asynchronous.  
@deprecated*

```

extensibility <soap:operation
  soapAction="http://edds.egos.esa/batchrequest/getFarcCatalogue"
  style="document"/>
input name="getFarcCatalogue" <soap:body use="literal"/>
output name="getFarcCatalogueResponse" <soap:body use="literal"/>

```

### getDataspaces

*Gets the dataspaces for the specified mission and request type. The method is synchronous.*

```

extensibility <soap:operation
  soapAction="http://edds.egos.esa/batchrequest/getDataspaces"
  style="document"/>
input name="getDataspaces" <soap:body use="literal"/>
output name="getDataspacesResponse" <soap:body use="literal"/>

```

### cancel

*This operation cancel a scheduled request or try to interrupt an already executing request. The operation takes in input the job ID of the operation to cancel and return the job ID of the cancel request. The operation is asynchronous.*

```

extensibility <soap:operation soapAction="http://edds.egos.esa/batchrequest/cancel"
  style="document"/>
input name="cancel" <soap:body use="literal"/>
output name="cancelResponse" <soap:body use="literal"/>

```

**suspend**

*This operation suspends an active request. The operation takes in input the job ID of the operation to suspend and return the job ID of the suspend request. The operation is asynchronous.*

```

extensi  <soap:operation soapAction="http://edds.egos.esa/batchrequest/suspend"
bility   style="document"/>

input   name="suspend"<soap:body use="literal"/>
output  name="suspendResponse"<soap:body use="literal"/>

```

**resume**

*This operation resumes a suspended or failed request. The operation takes in input the job ID of the operation to resume and return the job ID of the resumed request. The operation is asynchronous.*

```

extensi  <soap:operation soapAction="http://edds.egos.esa/batchrequest/resume"
bility   style="document"/>

input   name="resume"<soap:body use="literal"/>
output  name="resumeResponse"<soap:body use="literal"/>

```

**deleteData**

*This operation deletes the data related to a request. The operation is asynchronous.*

```

extensi  <soap:operation
bility   soapAction="http://edds.egos.esa/batchrequest/deleteData"
         style="document"/>

input   name="deleteData"<soap:body use="literal"/>
output  name="deleteDataResponse"<soap:body use="literal"/>

```

**deleteRequest**

*This operation deletes a request. The operation is asynchronous.*

```

extensi  <soap:operation
bility   soapAction="http://edds.egos.esa/batchrequest/deleteRequest"
         style="document"/>

input   name="deleteRequest"<soap:body use="literal"/>
output  name="deleteRequestResponse"<soap:body use="literal"/>

```

**getJobs**

*This operation returns the list of jobs over a defined time span. The operation takes in input the start and end date (where null is considered as ALL) and returns the list of operation that a user has right to read. The operation is synchronous.*

```

extensi  <soap:operation soapAction="http://edds.egos.esa/batchrequest/getJobs"
bility   style="document"/>

input   name="getJobs"<soap:body use="literal"/>
output  name="getJobsResponse"<soap:body use="literal"/>

```

**getJobsWithStatus**

*This operation returns the list of jobs with their status over a defined time span. The operation takes in input the start and end date (where null is considered as ALL) and returns the list of operation that a user has right to read. The operation is synchronous. The message contains a java.util.ArrayList of type RequestInfoRec encoded in Base64*

```

extensi  <soap:operation
bility   soapAction="http://edds.egos.esa/batchrequest/getJobsWithStatus"
         style="document"/>

```

```

input  name="getJobsWithStatus" <soap:body use="literal"/>
output name="getJobsWithStatusResponse" <soap:body use="literal"/>

```

### getHistoricalLog

*The operation return the SystemLog over a defined time span. The operation takes in input the start and end date (where null is considered as ALL) and returns the list of operation that a user has right to read. The operation is synchronous.*

```

extensi bility <soap:operation
  soapAction="http://edds.egos.esa/batchrequest/getHistoricalLog"
  style="document"/>
input  name="getHistoricalLog" <soap:body use="literal"/>
output name="getHistoricalLogResponse" <soap:body use="literal"/>

```

### getTransformations

*The operation returns the available transformations for the request type.*

```

extensi bility <soap:operation
  soapAction="http://edds.egos.esa/batchrequest/getTTransformations"
  style="document"/>
input  name="getTransformations" <soap:body use="literal"/>
output name="getTransformationsResponse" <soap:body use="literal"/>

```

### logIn

*Login the user and start the session*

```

extensi bility <soap:operation soapAction="http://edds.egos.esa/authentication/logIn"
  style="document"/>
input  name="logIn" <soap:body use="literal"/>
output name="logInResponse" <soap:body use="literal"/>

```

### hasSessionExpired

*Checks if the user's session has expired, and return true if it has*

```

extensi bility <soap:operation
  soapAction="http://edds.egos.esa/authentication/hasSessionExpired"
  style="document"/>
input  name="checkSession" <soap:body use="literal"/>
output name="checkSessionResponse" <soap:body use="literal"/>

```

### logOut

*Logout the user and close the session*

```

extensi bility <soap:operation soapAction="http://edds.egos.esa/authentication/logOut"
  style="document"/>
input  name="logOut" <soap:body use="literal"/>
output

```

### checkUserPassword

*Check if the password supplied matches the user's current password. Used to double check the user's current password before allowing the user to change their password.*

```

extensi bility <soap:operation
  soapAction="http://edds.egos.esa/authentication/checkUserPassword"

```



```

        style="document"/>
    input name="checkUserPassword"<soap:body use="literal"/>
    output name="checkUserPasswordResponse"<soap:body use="literal"/>

```

### accountRequest

*This operation performs an account management request. The operation is asynchronous: the detail of the request are contained in the request itself and the result of the operation is a job id. In case of error the operation returns an error.*

```

    extensibility <soap:operation
        soapAction="http://edds.egos.esa/userrequest/accountRequest"
        style="document"/>
    input <soap:body use="literal"/>
    output <soap:body use="literal"/>

```

### getUsers

*The operation return the list of users. The operation is synchronous. An error on the request will throw a fault*

```

    extensibility <soap:operation soapAction="http://edds.egos.esa/userrequest/getUsers"
        style="document"/>
    input name="getUsers"<soap:body use="literal"/>
    output name="getUsersResponse"<soap:body use="literal"/>

```

### getRoles

*The operation return the list of roles the user has permission to use for the specified mission. The operation is synchronous. An error on the request will throw a fault*

```

    extensibility <soap:operation soapAction="http://edds.egos.esa/userrequest/getRoles"
        style="document"/>
    input name="getRoles"<soap:body use="literal"/>
    output name="getRolesResponse"<soap:body use="literal"/>

```

### getMissions

*The operation return the list of missions. The operation is synchronous. An error on the request will throw a fault*

```

    extensibility <soap:operation
        soapAction="http://edds.egos.esa/userrequest/getMissions"
        style="document"/>
    input name="getMissions"<soap:body use="literal"/>
    output name="getMissionsResponse"<soap:body use="literal"/>

```

### getMissionsAndDomains

*The operation return the list of missions with their domains. The operation is synchronous. An error on the request will throw a fault*

```

    extensibility <soap:operation
        soapAction="http://edds.egos.esa/userrequest/getMissionsAndDomains"
        style="document"/>
    input name="getMissionsAndDomains"<soap:body use="literal"/>
    output name="getMissionsAndDomainsResponse"<soap:body use="literal"/>

```

### getUserAccountDetails

	<p><i>The operation return the details associated to a specific user as defined in the LDAP. The operation is synchronous. An error on the request will throw a fault</i></p> <pre> extensibility &lt;soap:operation   soapAction="http://edds.egos.esa/userrequest/getUserAccountDetails"   style="document"/&gt;  input name="getUserAccountDetails" &lt;soap:body use="literal"/&gt; output name="getUserAccountDetailsResponse" &lt;soap:body use="literal"/&gt; </pre> <p><b>getMissionDetails</b></p> <p><i>The operation return the details associated to a specific mission as defined in the LDAP. The operation is synchronous. An error on the request will throw a fault</i></p> <pre> extensibility &lt;soap:operation   soapAction="http://edds.egos.esa/userrequest/getMissionDetails"   style="document"/&gt;  input name="getMissionDetails" &lt;soap:body use="literal"/&gt; output name="getMissionDetailsResponse" &lt;soap:body use="literal"/&gt; </pre> <p><b>getUserQuota</b></p> <p><i>Returns the details for the specified mission</i></p> <pre> extensibility &lt;soap:operation   soapAction="http://edds.egos.esa/userrequest/getUserQuota"   style="document"/&gt;  input name="getUserQuota" &lt;wsdl:documentation&gt;The name of the mission&lt;/wsdl:documentation&gt;&lt;soap:body use="literal"/&gt; output name="getUserQuotaResponse" &lt;wsdl:documentation&gt;The quota details for the mission&lt;/wsdl:documentation&gt;&lt;soap:body use="literal"/&gt; </pre> <p><b>hasPermissionToSeeAllUsers</b></p> <p><i>Checks if user has permission to see other users data</i></p> <pre> extensibility &lt;soap:operation   soapAction="http://edds.egos.esa/userrequest/hasPermissionToSeeAllUsers"   style="document"/&gt;  input name="hasPermissionToSeeAllUsers" &lt;wsdl:documentation&gt;Username&lt;/ wsdl:documentation&gt;&lt;soap:body use="literal"/&gt; output name="permissionToSeeAllUsersResponse" &lt;wsdl:documentation&gt;The result whether user has permission to see other users data or not&lt;/wsdl:documentation&gt;&lt;soap:body use="literal"/&gt; </pre>
used by	Port <a href="#">EddsPort</a> in Service <a href="#">EddsService</a>

## **10. E-mail Interface**

### **10.1 *Data Elements***

The EDDS allows users to request the delivery of acknowledgement messages by email. This implies that the receiving client system has access to a mail server.

### **10.2 *Message Description***

The email contains a configurable message that can be tailored by the mission. The acknowledgement message is in attachment to the email in XML format.

### **10.3 *Communication Protocol***

SMTP is used by the EDDS.

### **10.4 *Errors***

A SMTP client cannot verify the correct reception of an email. It is assumed that the configuration for the email has been properly set by the mission and that the email address given by the user is valid.

## **11. File Server Interface**

### **11.1 Data Elements**

The EDDS allows users to request the delivery of batch responses to one or more client hosted file server(s). On completion of the batch request, the EDDS will try to deliver the response to the addresses given in the corresponding request.

### **11.2 Message Description**

A description of a File server delivery request can be found in section Appendix C

A description of a batch response can be found in section Appendix C

### **11.3 Communication Protocol**

The EDDS uses the FTP protocol (or SFTP depending on the mission configuration) to deliver the batch response using the PUT method. The client's file server must support the PUT action.

### **11.4 Errors**

If a batch response cannot be delivered to one or more of the remote FTP server(s) (after a number of retries) it may be deleted or retained (for a limited period) on the EDDS server as described in the original batch request.

## 12. Client API

The section describes the Java APIs provided by the EDDS application. The purpose of the APIs are to allow a client application access to the EDDS services. After the “package” Ant target has been run within the EDDS source directories, the JAR file can be found within “edds-ws-client/target/edds-ws-client-1.2.1.jar”. After the “generate-runtime” target has been run, the library is copied to the 3<sup>rd</sup> party software directory. See the Configuration and Installation Guide (CIG) [RD-15] for information on how to run Ant targets.

The EDDS APIs are derived from the definition of the EDDS Web Services. The API's implement a façade pattern on top of the classes generated from the WSDL files, which describe the EDDS services. They hide the implementation details of the services, like the connection to the web server.

EDDS Client API offers the following types of methods:

- EDDS Web Services client
- EDDS Push notifications client
- Utility methods

## 12.1 Edds Web Services Client API

The tables below describe the Client API. The class EddsService is a façade to the application and acts as a singleton. The methods available in the API match exactly those listed in Section 9.4.

### 12.1.1 Instantiating

Operation	Returns	Description
static setServerEndPoint(String address)	void	Sets the end-point to the address specified
static getInstance()	EddsService	Gets the singleton instance
connectToServer()	void	Connects to the server on a previously set address
init()	void	Initialise the service.

### 12.1.2 Session Management

Operation	Returns	Description
login(String userName, String password)	String	Creates session with server, also reconnects NotificationManager. Returns session ID.
hasSessionExpired()	boolean	Checks if the user's session has expired, or has not been created
checkUserPassword(String password)	void	Check if the password supplied matches the user's current password.

### 12.1.3 Issuing Requests

Operation	Returns	Description
batchRequest(RequestMessagePart parameters)	JobListIdPart	Submit a batch request.
streamRequest(StreamRequestMessagePart parameters)	JobIdPart	Perform a stream request.

### 12.1.4 Managing Requests

Operation	Returns	Description
cancel(CancelPartList cancelJobIds)	AcknowledgementPartList	Sends a Cancel request
reSubmit(JobIdPart job)	JobListIdPart	Resubmits the given request as a new request.
suspend(SuspendPartList suspendJobIds)	AcknowledgementPartList	Suspend request(s)
resume(ResumePartList resumeJobIds)	AcknowledgementPartList	Resume request(s)
deleteData(JobIdPartList requestIds)	AcknowledgementPartList	Delete response data
deleteRequest(JobIdPartList requestIds)	AcknowledgementPartList	Delete request(s) and their response data
startStreamData(JobIdPart jobIdPart)	void	Start the stream from the web server to the client using CometD for the specified active stream request
stopStreamData(JobIdPart jobIdPart)	void	Stop the stream from the web server to the client using CometD for the specified active stream request

### 12.1.5 Special Requests

Operation	Returns	Description
getParamDefinitions(String mission)	JobIdPart	Initiates the retrieval of parameter definitions for the specified mission.
getDataspaces(String mission, String domain, DataAccessDataElement requestType)	List<String>	Gets the available dataspaces from the EDDS server for the specified mission, domain (optional) and request type.
getFarcCatalogue(String mission, String domain, String folder)	JobIdPart	Initiates the retrieval of a FARC Catalogue for the specified mission, domain and folder.
getFsCatalogue(String mission, String folder)	String - the request ID	Initiates the retrieval of a File System Catalogue for the specified mission and folder
getHistoricalLog(Date from, Date to)	JobIdPart	Return a list of historical log messages between the from and to date.

### 12.1.6 Utility Methods for Requests

Operation	Returns	Description
getResponse(DownloadList downloadList)	ResponseData	Gets the response file(s) from EDDS File server.
getJobs(XMLGregorianCalendar start, XMLGregorianCalendar end)	JobListIdPart	Gets the jobs in the given time windows.
getJobsWithStatus(XMLGregorianCalendar start, XMLGregorianCalendar end)	JobIdPart	Gets the status of jobs in the given time windows.
getStatus(JobIdPart job)	AcknowledgementPart	Gets the acknowledgement.
getStatuses(JobListIdPart jobs)	JobIdPart	Gets the statuses of multiple jobs.
getRequest(JobIdPart job)	RequestMessagePart	Return the specified RequestMessagePart
getRequest(String job)	RequestMessagePart	Return the specified RequestMessagePart
getStreamRequest(JobIdPart job)	StreamRequestMessagePart	Return the specified StreamRequestMessagePart

### 12.1.7 Utility Methods for User Management

Operation	Returns	Description
getMissions()	MissionsList	Gets all the mission names.
getMissionsAndDomains()	MissionsDomainList	Gets all the mission names and domains.
getMissionDetails(String mission)	MissionDetailsList	Gets all the details for the specified mission.
getRoles(String missionName)	RolesList	Gets all the roles for the specified mission
getUsers(boolean includeAll)	UsersList	Returns a the list of EDDS users
getUserAccountDetails(String username)	UserAccountDetails	Returns the full account details of the specified user
getUserQuota(String mission)	UserQuotaDetailsList	Gets the current user quota usage for the specified mission.
hasPermissionToSeeAllUsers(String username)	boolean	Checks if user has permission to see other users data.
getTransformations(String mission, DataAccessDataElement type)	List<String>	Retrieves the list of available transformations for given mission and request type

## 12.1.8 Edds Client API – code examples

This section provides some snippets of code in order to facilitate the developer in the usage of the library. The code is quite minimalistic since all the complexity of the SOAP protocol is hidden by the library.

### 12.1.8.1 LogIn

```
/**
 * Perform the login of a user and open a session on the web server.
 *
 * @param username The username
 * @param password The password
 * @throws WebServiceException
 * @throws MalformedURLException
 * @throws PasswordExpiredFault
 */
public void logIn(String username, String password) throws
MalformedURLException, WebServiceException, PasswordExpiredFault
{
    String serverAddress =
"http://10.48.29.159:8080/edds/EddsService?wsdl";
    System.setProperty(EddsService.DEFAULT_ENDPOINT_ADDRESS,
serverAddress);
    EddsService edds = EddsService.getInstance();
    edds.connectToServer();

    try
    {
        edds.logIn(username, password);
    }
    catch (AuthenticationFault ex)
    {
        // exception management
    }
}
```

### 12.1.8.2 LogOut

```
/**
 * Close the session of the user
 *
 * @param username The username
 * @param password The password
 * @throws WebServiceException
 * @throws MalformedURLException
 */
public void logOut(String username, String password) throws
MalformedURLException, WebServiceException
{
    // we assume the login has been already performed
    EddsService.getInstance().logOut();
}
```

### 12.1.8.3 GetStatus

```
/**
 * Return the status of a request
 *
 * @param jobIdPart The ID of the request
 * @throws WebServiceException
 * @throws MalformedURLException
```



```

    */
    public void getStatus(JobIdPart jobIdPart) throws
    MalformedURLException, WebServiceException
    {
        try
        {
            // we assume the login has been already performed
            EddsService edds = EddsService.getInstance();

            // we have as return the complete acknowledgement of the
            request
            AcknowledgementPart acknowledgment =
            edds.getStatus(jobIdPart);

            // ...
        }
        catch (RequestFault ex)
        {
            // exception management
        }
        catch (SessionFault ex)
        {
            // exception management
        }
        catch (AuthorizationFault ex)
        {
            // exception management
        }
    }
}

```

#### 12.1.8.4 Get request statuses

```

/**
 * Return the request information of multiple requests
 *
 * @param jobListIdPart The IDs of the requests
 * @throws WebServiceException
 * @throws DatatypeConfigurationException
 * @throws ClassNotFoundException
 * @throws IOException
 * @throws TimeFormatException
 */
public void getJobsWithStatuses(JobListIdPart jobListIdPart) throws
WebServiceException, DatatypeConfigurationException, IOException,
    ClassNotFoundException, TimeFormatException
{
    try
    {
        // we assume the login has been already performed
        EddsService edds = EddsService.getInstance();

        // Create a start time
        Date startTime = new Date(System.currentTimeMillis());
        GregorianCalendar startTimeGregorian = new
        GregorianCalendar();
        startTimeGregorian.setTime(startTime);
        XMLGregorianCalendar startTimeXml =
        DatatypeFactory.newInstance().newXMLGregorianCalendar(startTimeGregorian)
        ;
    }
}

```

```

        // Create an end time
        Date endTime = new Date(System.currentTimeMillis());
        GregorianCalendar endTimeGregorian = new GregorianCalendar();
        endTimeGregorian.setTime(endTime);
        XMLGregorianCalendar endTimeXml =
DatatypeFactory.newInstance().newXMLGregorianCalendar(endTimeGregorian);

        // we have as return a job ID which can be used to identify
the response from CometD. The JobID is a random string, not a RequestId
        JobIdPart jobId = edds.getJobsWithStatus(startTimeXml,
endTimeXml);
    }
    catch (RequestFault ex)
    {
        // exception management
    }
    catch (SessionFault ex)
    {
        // exception management
    }
    catch (AuthorizationFault ex)
    {
        // exception management
    }
}

```

#### 12.1.8.5 Perform BatchRequest

```

/**
 * Perform a batch request
 *
 * @param request The request message
 * @throws WebServiceException
 * @throws MalformedURLException
 */
public void batchRequest(RequestMessagePart request) throws
MalformedURLException, WebServiceException
{
    try
    {
        // we assume the login has been already performed
        EddsService edds = EddsService.getInstance();

        // the request is submitted and we receive the related ID
        JobListIdPart jobId = edds.batchRequest(request);

        // ...
    }
    catch (RequestFault ex)
    {
        // exception management
    }
    catch (SessionFault ex)
    {
        // exception management
    }
    catch (AuthorizationFault ex)
    {
        // exception management
    }
}

```

### 12.1.8.6 Perform StreamRequest

```

/**
 * Perform a stream request
 *
 * @param request The request message
 * @throws WebServiceException
 * @throws MalformedURLException
 */
public void streamRequest(StreamRequestMessagePart request) throws
MalformedURLException, WebServiceException
{
    try
    {
        // we assume the login has been already performed
        EddsService edds = EddsService.getInstance();

        // the request is submitted and we receive the related ID
        JobListIdPart jobId = edds.streamRequest(request);

        // ...
    }
    catch (RequestFault ex)
    {
        // exception management
    }
    catch (SessionFault ex)
    {
        // exception management
    }
    catch (AuthorizationFault ex)
    {
        // exception management
    }
}

```

To receive the stream data, follow the example in Section 12.2.2, using `NotificationChannel.PARAM_STREAM` as the channel to listen to, and implement `NotificationListener <DarcParamRec>`. Next call the method `startStreamData(requestId)` in the Client API to request that the Web Server starts to send the stream data to your application. When finished, ensure you call `stopStreamData(requestId)`. The `RequestId` to pass is the one returned to you from the above method - `streamRequest(request)`.

### 12.1.8.7 Cancel

```

/**
 * Cancels request(s)
 *
 * @param jobIds The request IDs
 * @throws WebServiceException
 * @throws MalformedURLException
 */
public void cancel(CancelPartList jobIds) throws
MalformedURLException, WebServiceException
{
    try
    {
        // we assume the login has been already performed
        EddsService edds = EddsService.getInstance();

```

```

        // we have as return the complete acknowledgement of the
request(s)
        AcknowledgementPartList acknowledgements =
edds.cancel(jobIds);

        // ...
    }
    catch (RequestFault ex)
    {
        // exception management
    }
    catch (SessionFault ex)
    {
        // exception management
    }
    catch (AuthorizationFault ex)
    {
        // exception management
    }
}

```

### 12.1.8.8 Suspend

```

/**
 * Suspends a request(s)
 *
 * @param jobIds The request IDs
 * @throws WebServiceException
 * @throws MalformedURLException
 */
public void suspend(SuspendPartList jobIds) throws
MalformedURLException, WebServiceException
{
    try
    {
        // we assume the login has been already performed
        EddsService edds = EddsService.getInstance();

        // we have as return the complete acknowledgement of the
request(s)
        AcknowledgementPartList acknowledgements =
edds.suspend(jobIds);

        // ...
    }
    catch (RequestFault ex)
    {
        // exception management
    }
    catch (SessionFault ex)
    {
        // exception management
    }
    catch (AuthorizationFault ex)
    {
        // exception management
    }
}

```

**12.1.8.9 Resume**

```

/**
 * Resumes a request(s)
 *
 * @param jobIds The request IDs
 * @throws WebServiceException
 * @throws MalformedURLException
 */
public void resume(ResumePartList jobIds) throws
MalformedURLException, WebServiceException
{
    try
    {
        // we assume the login has been already performed
        EddsService edds = EddsService.getInstance();

        // we have as return the complete acknowledgement of the
request(s)
        AcknowledgementPartList acknowledgements =
edds.resume(jobIds);

        // ...
    }
    catch (RequestFault ex)
    {
        // exception management
    }
    catch (SessionFault ex)
    {
        // exception management
    }
    catch (AuthorizationFault ex)
    {
        // exception management
    }
}

```

**12.1.8.10 Get parameter definitions**

```

public void getParamDefinitions(String mission)
{
    try
    {
        // we assume the login has been already performed
        EddsService edds = EddsService.getInstance();

        JobIdPart jobId = edds.getParamDefinitions(mission);

        // ...
    }
    catch (MalformedURLException e)
    {
        // exception management
    }
    catch (WebServiceException e)
    {
        // exception management
    }
    catch (RequestFault e)
    {

```

```
        // exception management
    }
    catch (SessionFault e)
    {
        // exception management
    }
    catch (AuthorizationFault e)
    {
        // exception management
    }
}
```

### 12.1.8.11 Download response file

```
/**
 * Save the response files for the given jobId locally
 *
 * @param jobId the request id
 */
public void saveResponseFiles(String jobId) throws
WebServiceException, RequestFault, SessionFault, AuthorizationFault,
    FileNotFoundException, IOException
{
    DownloadList downloadList = new DownloadList();
    downloadList.setJob(jobId);
    List <ResponseDataElement> dataHandlers =
EddsService.getInstance().getResponse(downloadList).getResponseDataElement();

    // Save the response files
    for (ResponseDataElement responseElem : dataHandlers)
    {
        BufferedOutputStream bos = new BufferedOutputStream(new
FileOutputStream(new File(responseElem.getFileName())));
        responseElem.getResponse().writeTo(bos);
        bos.close();
    }
}
```

## 12.2 EDDS Push notifications client

EDDS clients can register their listeners to receive push notification on messages from EDDS system. The client listeners are called asynchronously when any messages are received. Supported notification types are:

Channel (from NotificationChannel)	enum	Return Type	Description
USER_MANAGEMENT		AccountRequestMessagePart	User management updates
STATUS_UPDATES		RequestInfoRec	Job updates
STATUS_RETRIEVAL		RequestInfoRecs	Used to get a list of jobs and their status
STATUS_RETRIEVAL_ERRORS		String	Error message if unable to retrieve status information
EDDS_LOGS		LoggingEvent	EDDS live system log messages
PARAM_DEFINITIONS		ParamDefRecs	Parameter definitions
PARAM_DEFINITIONS_ERRORS		String	Parameter definition errors
ARCHIVE_CATALOGUE			The FARC catalogue entries
ARCHIVE_CATALOGUE_ERRORS		String	Any error information when retrieving the catalogue
ARCHIVE_UPDATES		FarcCatRec	Information about a new commit in the FARC
HISTORICAL_LOGS		SystemLogRec	Historical logs
USER_QUOTA_USAGE		UserQuotaDetailsList	Quota updates
PARAM_STREAM		DarcParamRec	DARC parameter stream
FILE_SYSTEM_CATALOGUE		Catalogue	The File System Catalogue entries in response to the Special request for File System
FILE_SYSTEM_UPDATES		FsCatalogueEntry	Notifications about changes in designated File System directory.

### 12.2.1 Security

The same session key that is obtained during login of EDDS Web services is used to authenticate the client. If client fails to provide the server with an existing session key, the service is denied.

### 12.2.2 Example: Register notifications listener

```
/**
 * Register your listener to receive asynchronous notifications for
 * status updates
 *
 * @param listener the listener the will receive updates when they
 * are received from the EDDS Web Server
 * @see NotificationManager#registerListener(NotificationChannel,
 * NotificationListener) for the list supported types
 */
public void registerStatusUpdatesListener(NotificationListener <byte[]>
listener)
```

```

    {
NotificationManager.getInstance().registerListener(NotificationChannel.ST
ATUS_UPDATES, listener);
    }

```

## 12.3 EDDS Utility methods

### 12.3.1 Decoding EDDS Param Binary format

EDDS Client API provides utility functions to read and write the TM Parameter binary format. The implementation is in package `esa.egos.edds.ws.client.binary`. For more detailed documentation read the Javadoc of the provided classes.

#### 12.3.1.1 Example: Reading Parameter TM data from EDDS Binary file

```

/**
 * Read the Parameter BINARY response file. It contains a list of {@link
DarcParameterBinary} objects
 * encoded using Google Protocol Buffers. Each record is prepended with
it's length.
 * @param file the file object of the file being read.
 * @throws InvalidProtocolBufferException when something unexpected occurs
while reading the data
 * @throws IOException problem reading the file
 */
public void readParamBinaryFormat(File file) throws
InvalidProtocolBufferException, IOException{
    DarcParameterBinaryInputSupport bin = new
DarcParameterBinaryInputSupport(file);
    DarcParamBinary rec;
    while ( (rec = bin.next()) != null)
    {
        System.out.println(rec.getParamName() + " " + rec.getGenTime() + "
" + rec.getValue());
    }
    bin.close();
}

```

## 12.4 Dependencies

To use EDDS Client API the following libraries need to be on the classpath.

Library	Description
edds-ws-client-1.5.0.jar	The main API library
edds-ws-common-1.5.0.jar	Shared dependency between EDDS clients and EDDS system
edds-common-1.5.0.jar	
bayeux-api-2.2.0.jar	CometD Java client libraries to enable push notifications
cometd-java-client-2.2.0.jar	
cometd-java-common-2.2.0.jar	
commons-codec-1.6.jar	Required for decoding Base64 encoded data
commons-lang-2.6.jar	Used for creating a hash code for objects
jetty-client-7.4.0.v20110414.jar	Transitive dependencies for CometD



jetty-http-7.4.0.v20110414.jar	
jetty-io-7.4.0.v20110414.jar	
jetty-util-7.4.0.v20110414.jar	
log4j-1.2.15.jar	For passing logging messages.
jaxb-api-2.1.jar	JAX-WS 2.1 API and Implementation
jaxb-impl-2.1.11.jar	
jaxws-api-2.1.jar	
jaxws-rt-2.1.7.jar	
mimepull-1.3.java	Required only for large downloads of files
stax-ex-1.2.jar	Dependencies for JAX-WS for encoding/decoding data and XML
streambuffer-0.9.jar	
activemq-all-5.7.0.jar	Required <b>only</b> for the Google Protocol Buffers implementation
quartz-1.7.1-jar	Quartz Scheduler library. Needed for parsing Cron expressions.
slf4j-api-1.6.6.jar	Required by activemq-all-5.7.0.jar
slf4j-log4j-1.6.6.jar	Required by activemq-all-5.7.0.jar

# Appendix A Acknowledgement Data Type

## A.1 complexType AcknowledgementPart

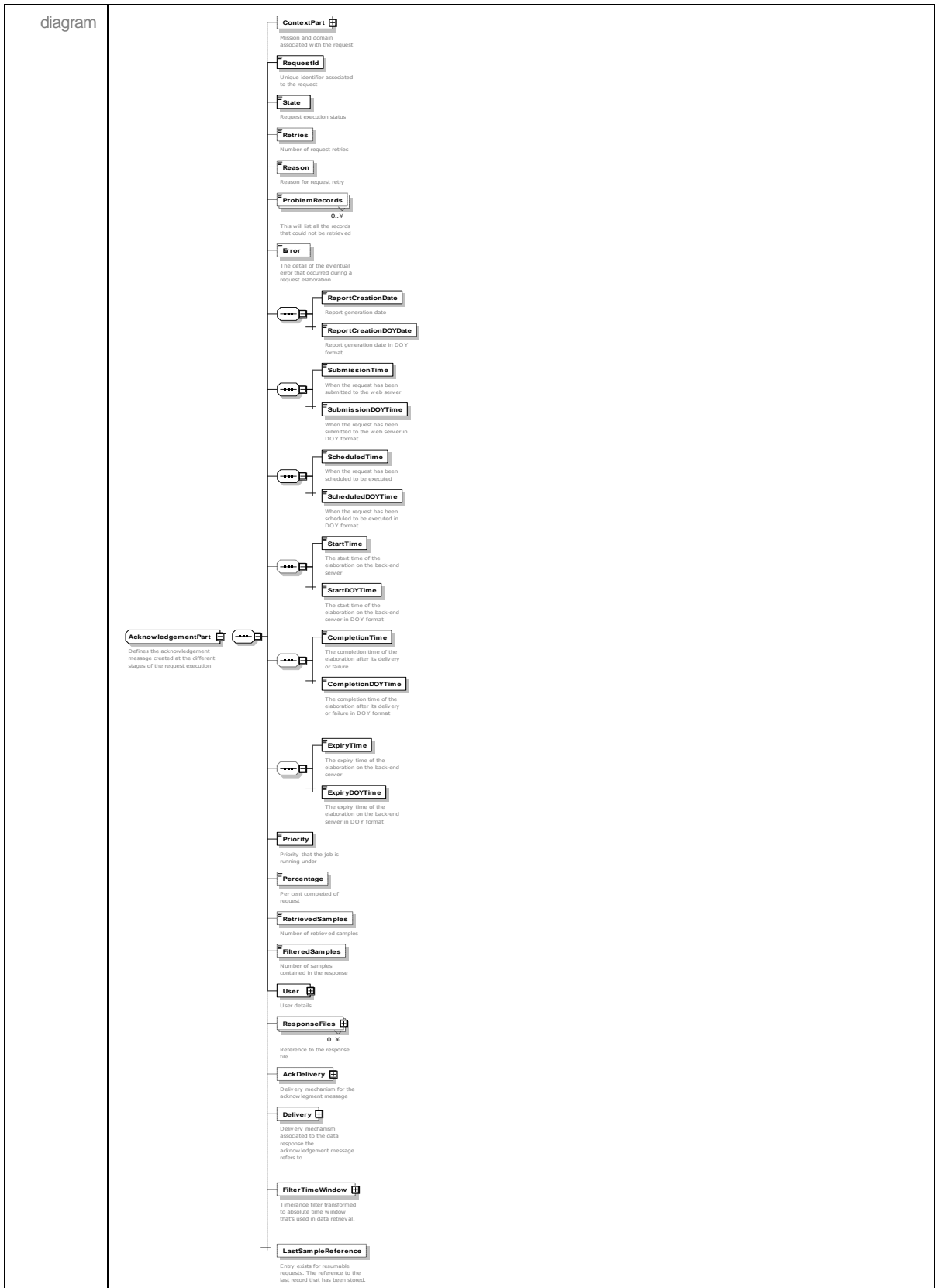

namespace	http://edds.egos.esa/model
children	<b>ContextPart RequestId State Retries Reason ProblemRecords Error ReportCreationDate ReportCreationDOYDate SubmissionTime SubmissionDOYTime ScheduledTime ScheduledDOYTime StartTime StartDOYTime CompletionTime CompletionDOYTime ExpiryTime ExpiryDOYTime Priority Percentage RetrievedSamples FilteredSamples User ResponseFiles AckDelivery Delivery FilterTimeWindow LastSampleReference</b>
used by	element <b>AcknowledgementPartList/AcknowledgementPart</b>
annotation	documentation Defines the acknowledgement message created at the different stages of the request execution

### A.2 complexType AcknowledgementPartList

diagram	
namespace	http://edds.egos.esa/model
children	<b>AcknowledgementPart</b>
annotation	documentation Defines the a list of acknowledgement messages

### A.3 complexType DarcRetrieveReference

diagram	
namespace	http://edds.egos.esa/model
type	extension of <a href="#">SampleReference</a>
properties	base SampleReference
children	<b>TimeStamp CurrentType</b>
annotation	documentation Information to resume a DARC parameter sample request, which uses retrieve by type mode (instead of retrieve by parameter).

### A.4 complexType FileSystemNameReference

diagram	
namespace	http://edds.egos.esa/model
type	extension of <a href="#">RetrievalReference</a>
properties	base RetrievalReference

children	<b>CurrentName</b>
annotation	documentation A reference to the last file entry retrieved from filesystem.

### A.5 complexType ParameterSampleReference

diagram	
namespace	http://edds.egos.esa/model
type	extension of <b>SampleReference</b>
properties	base <b>SampleReference</b>
children	<b>TimeStamp ParamName</b>
annotation	documentation References a parameter sample. Holds a parameter name and a timestamp.

### A.6 complexType ResponseFileEntry

diagram	
namespace	http://edds.egos.esa/model
children	<b>FileName Size Status Error Checksum</b>
used by	element <b>AcknowledgementPart/ResponseFiles</b>
annotation	documentation Defines the response file and it's status

### A.7 complexType RetrievalReference

diagram	 <p><b>RetrievalReference</b></p> <p>A bstract type that defines a reference to the last stored location of data.</p> <p>This is the parent for all other reference types.</p>
namespace	http://edds.egos.esa/model
properties	abstract true
used by	element <b>AcknowledgementPart/LastSampleReference</b> complexTypes <a href="#">FileSystemNameReference</a> <a href="#">SampleReference</a>
annotation	documentation Abstract type that defines a reference to the last stored location of data. This is the parent for all other reference types.

### A.8 complexType SampleReference

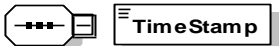
diagram	  <p><b>SampleReference</b></p> <p>Defines a reference to a response sample.</p> <p><b>TimeStamp</b></p> <p>The time stamp</p>
namespace	http://edds.egos.esa/model
type	extension of <a href="#">RetrievalReference</a>
properties	base RetrievalReference
children	<b>TimeStamp</b>
used by	complexTypes <a href="#">DarcRetrieveReference</a> <a href="#">ParameterSampleReference</a> <a href="#">SampleTimeStamp</a>
annotation	documentation Defines a reference to a response sample.

A.8

### A.9 complexType SampleTimeStamp

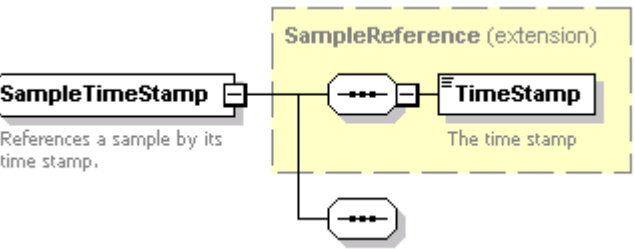
diagram	 <p><b>SampleTimeStamp</b></p> <p>References a sample by its time stamp.</p> <p><b>SampleReference (extension)</b></p> <p><b>TimeStamp</b></p> <p>The time stamp</p>
namespace	http://edds.egos.esa/model
type	extension of <b>SampleReference</b>
properties	base SampleReference
children	<b>TimeStamp</b>
annotation	documentation References a sample by its time stamp.

A.9  
A.8

### A.10 simpleType ResponseFileStatus

namespace	http://edds.egos.esa/model
-----------	----------------------------

A.9  
A.8

A.9

type	restriction of <b>xs:string</b>		
properties	base <b>xs:string</b>		
used by	element <b>ResponseFileEntry/Status</b>		
facets	Kind	Value	annotation
	enumeration	ACTIVE	documentation The file is being written by the EDDS Server
	enumeration	SERVER_COMPLETED	documentation EDDS Server completed writing the file, delivery-manager needs to deliver the file
	enumeration	DELIVERED_LOCAL	documentation The file is available in the EDDS Server FTP directory
	enumeration	DELIVERED_LOCAL_REMOTE	documentation The file is delivered to the remote server and is also available in the EDDS Server FTP directory
	enumeration	DELIVERED_REMOTE	documentation The delivery of the file is completed
	enumeration	DELETED	documentation The data on EDDS file server is deleted. Can be reached after DELIVERED_LOCALLY or DELIVERED_LOCAL_REMOTE
	enumeration	ERROR	documentation The file cannot be saved on EDDS file server
annotation	documentation Response file statuses		

## Appendix B Authentication Data Type

This section of the document describes the complex types used for authentication as defined in the authentication.xsd file.

### B.1 complexType *UserCredentials*

diagram	
namespace	http://edds.egos.esa/model
children	<b>UserName Password SessionId</b>
used by	element <b>UserCredentials</b>
annotation	documentation Security info needed during the user login

## Appendix C Batch Request Data Type

This section of the document describes the complex types used for batch requests as defined in the batchrequest.xsd file.

### C.1 complexType ArchiveCatalogue

diagram	<p><b>DataRequestBase (extension)</b></p> <ul style="list-style-type: none"> <li><b>DataSource</b>: Defines the data source associated with the request</li> <li><b>RequestPostProcessing</b>: Defines if the request response has to be compressed or and encrypted.</li> <li><b>Delivery</b>: Defines the mechanism used to deliver the data response to the user.</li> <li><b>UseNoDomain</b>: The FARC has an additional "domain" called "No Domain" which holds information that is not domain specific and applies for all domains. If this flag is set to true, the request will apply to the "No Domain" archive.</li> <li><b>CatalogueFilter</b>: Defines the basic information necessary to retrieve the data Catalogue from the FARC archive and defines the filter to be applied to the retrieved data.</li> <li><b>CatalogueFormat</b>: Defines the possible format which is applied to the data response.</li> </ul> <p><b>ArchiveCatalogue</b>: Defines the Archive Catalogue data request</p>
namespace	http://edds.egos.esa/model
type	extension of <b>DataRequestBase</b>
properties	base DataRequestBase
children	<b>RequestPostProcessing Delivery UseNoDomain CatalogueFilter CatalogueFormat</b>
used by	elements <b>ArchiveCatalogue DataRequest/ArchiveCatalogue</b>
annotation	documentation Defines the Archive Catalogue data request



## C.2 complexType ArchiveFile

<p>diagram</p>	<pre> classDiagram     class ArchiveFile {         DataSource         RequestPostProcessing         Delivery         UseNoDomain         ArchiveFileFilter         ArchiveFileFormat     }     class DataRequestBase {         DataSource         RequestPostProcessing         Delivery     }     class UseNoDomain {     }     class ArchiveFileFilter {     }     class ArchiveFileFormat {     }     ArchiveFile .. &gt; DataRequestBase : extension     DataRequestBase .. &gt; : extension     </pre> <p><b>ArchiveFile</b> Defines the Archive File data request</p> <p><b>DataRequestBase (extension)</b></p> <ul style="list-style-type: none"> <li><b>DataSource</b> Defines the data source associated with the request</li> <li><b>RequestPostProcessing</b> Defines if the request response has to be compressed or and encrypted.</li> <li><b>Delivery</b> Defines the mechanism used to deliver the data response to the user.</li> </ul> <p><b>UseNoDomain</b> The FARC has an additional "domain" called "No Domain" which holds information that is not domain specific and applies for all domains. If this flag is set to true, the request will apply to the "No Domain" archive.</p> <p><b>ArchiveFileFilter</b> Defines the basic information necessary to retrieve the data file from the FARC archive and defines the filter to be applied to the retrieved data.</p> <p><b>ArchiveFileFormat</b> Defines the possible format which is applied to the data response.</p>
<p>namespace</p>	<p>http://edds.egos.esa/model</p>
<p>type</p>	<p>extension of <b>DataRequestBase</b></p>
<p>properties</p>	<p>base <b>DataRequestBase</b></p>
<p>children</p>	<p><b>RequestPostProcessing Delivery UseNoDomain ArchiveFileFilter ArchiveFileFormat</b></p>
<p>used by</p>	<p>elements <b>ArchiveFile DataRequest/ArchiveFile</b></p>
<p>annotation</p>	<p>documentation Defines the Archive File data request</p>

### C.3 complexType ArchiveSubscription

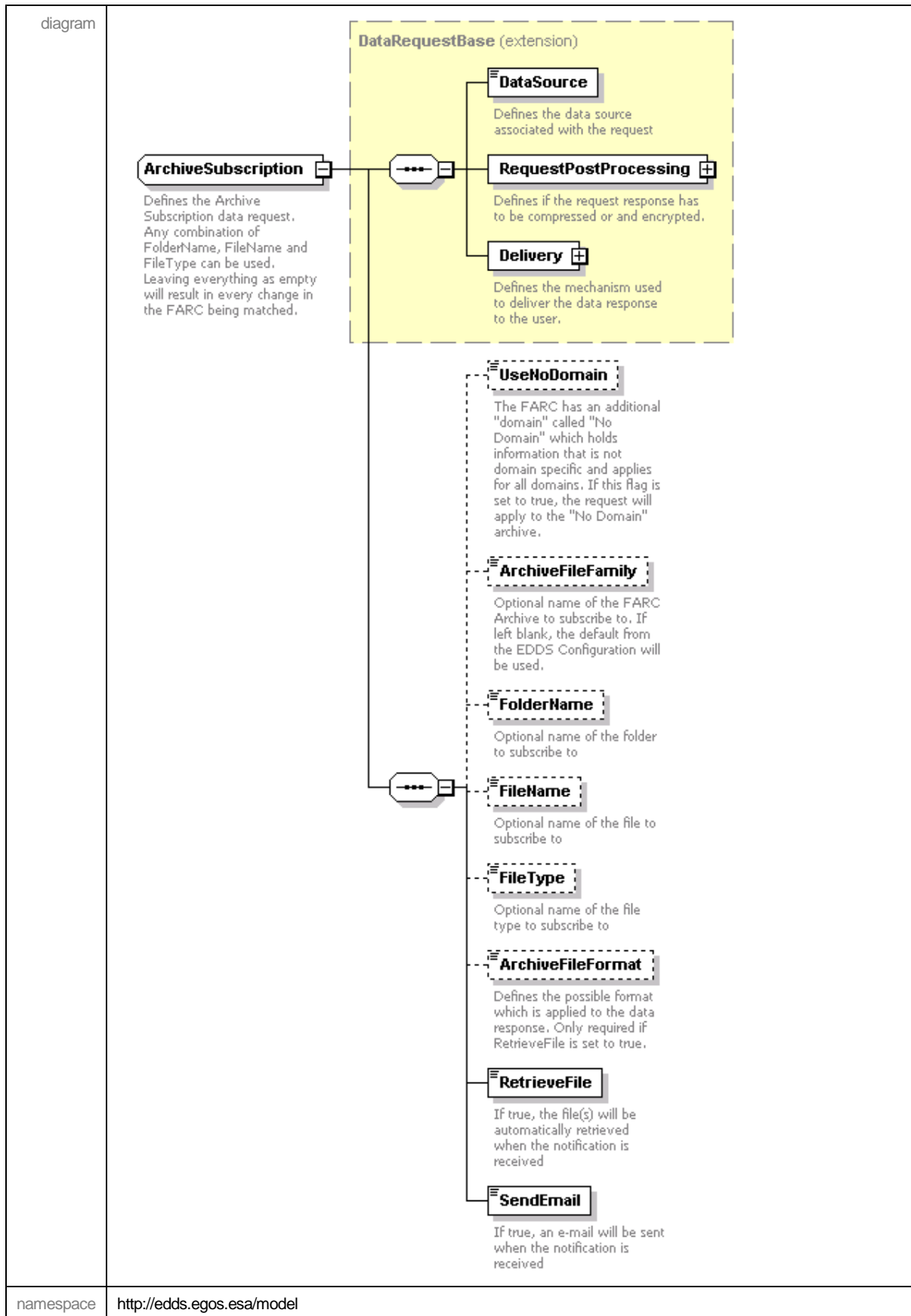

type	extension of <b>DataRequestBase</b>
properties	base <b>DataRequestBase</b>
children	<b>RequestPostProcessing Delivery UseNoDomain ArchiveFileFamily FolderName FileName FileType ArchiveFileFormat RetrieveFile SendEmail</b>
used by	elements <b>ArchiveSubscription DataRequest/ArchiveSubscription</b>
annotation	documentation Defines the Archive Subscription data request. Any combination of FolderName, FileName and FileType can be used. Leaving everything as empty will result in every change in the FARC being matched.

### C.4 complexType ArchiveSubscriptionNotification

diagram	
namespace	http://edds.egos.esa/model
children	<b>RequestId FolderName FileName FileType Domain ArchiveFamily OperationType Issue Revision</b>
used by	element <b>ArchiveSubscriptionNotification</b>
annotation	documentation Information about a commit to the FARC

### C.5 complexType BatchRequest

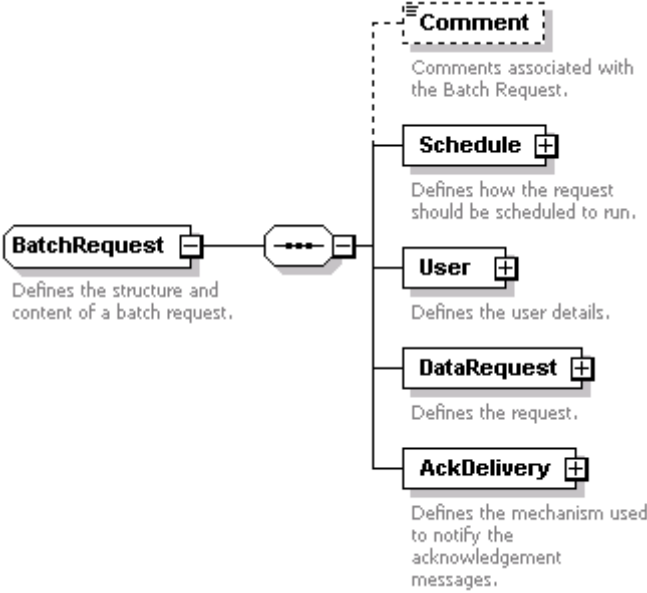
<p>diagram</p>	
<p>namespace</p>	<p>http://edds.egos.esa/model</p>
<p>children</p>	<p><b>Comment Schedule User DataRequest AckDelivery</b></p>
<p>used by</p>	<p>elements <b>BatchRequest RequestMessagePart/BatchRequest</b></p>
<p>annotation</p>	<p>documentation Defines the structure and content of a batch request.</p>

### C.6 complexType BehaviourState

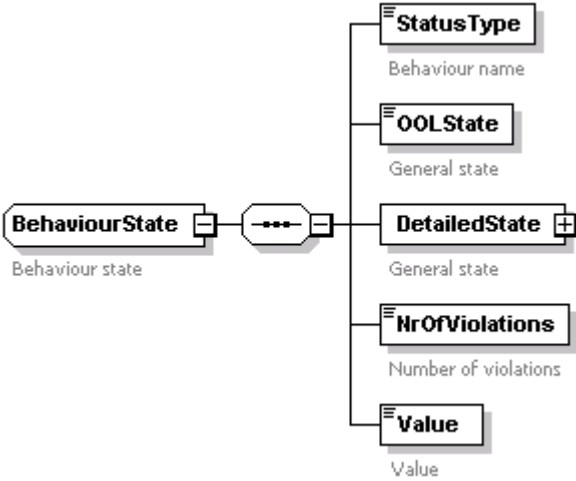
<p>diagram</p>	
<p>namespace</p>	<p>http://edds.egos.esa/model</p>
<p>children</p>	<p><b>StatusType OOLState DetailedState NrOfViolations Value</b></p>
<p>used by</p>	<p>element <b>BehaviourStates/BehaviourState</b></p>
<p>annotation</p>	<p>documentation Behaviour state</p>

## C.7 complexType BehaviourStates

diagram	<p>Behaviour states</p> <p>0..∞</p> <p>Defines the behaviour state element</p>
namespace	http://edds.egos.esa/model
children	<b>BehaviourState</b>
used by	element <b>ParamRepresentationSample/BehaviourStates</b>
annotation	documentation Behaviour states

## C.8 complexType CancelPart

diagram	<p>CancelPart</p> <p>Defines the message the client submits to cancel a request under execution</p> <p>InterruptPart (extension)</p> <p>User</p> <p>User details</p> <p>JobIdPart</p> <p>Defines the id of the request to be interrupted</p>
namespace	http://edds.egos.esa/model
type	extension of <b>InterruptPart</b>
properties	base <b>InterruptPart</b>
children	<b>User JobIdPart</b>
used by	element <b>CancelPart</b>
annotation	documentation Defines the message the client submits to cancel a request under execution

## C.9 complexType CancelPartList

diagram	<p>CancelPartList</p> <p>defines a list of cancel requests</p> <p>0..∞</p> <p>CancelPart</p>
namespace	http://edds.egos.esa/model
children	<b>CancelPart</b>
used by	element <b>CancelPartList</b>
annotation	documentation defines a list of cancel requests

### C.10 complexType CatalogueRequest

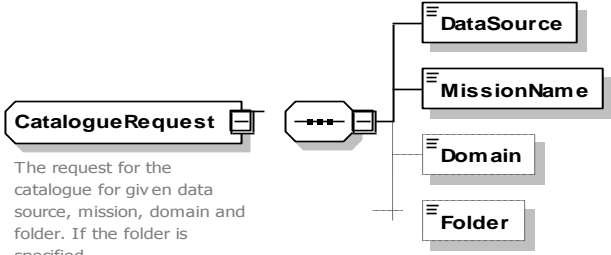
<p>diagram</p>	 <p>The request for the catalogue for given data source, mission, domain and folder. If the folder is specified the request will be non-recursive.</p>
<p>namespace</p>	<p>http://edds.egos.esa/model</p>
<p>children</p>	<p><b>DataSource MissionName Domain Folder</b></p>
<p>used by</p>	<p>element <b>CatalogueRequest</b></p>
<p>annotation</p>	<p>documentation The request for the catalogue for given data source, mission, domain and folder. If the folder is specified the request will be non-recursive.</p>

### C.11 complexType CatalogueResponse

<p>diagram</p>	 <p>Defines the list of catalogue entry</p> <p>0..∞</p> <p>Defines the single catalogue entry</p>
<p>namespace</p>	<p>http://edds.egos.esa/model</p>
<p>children</p>	<p><b>CatalogueResponseElement</b></p>
<p>used by</p>	<p>element <b>Response/CatalogueResponse</b></p>
<p>annotation</p>	<p>documentation Defines the list of catalogue entry</p>

### C.12 complexType CatalogueResponseElement

<p>diagram</p>	<p><b>CatalogueResponseElement</b> Describes the single catalogue entry</p> <ul style="list-style-type: none"> <li><b>DataObjectid</b> Defines the unique object id</li> <li><b>FileName</b> Defines the name of the catalogue file entry</li> <li><b>FileType</b> Defines the type of the catalogue file entry</li> <li><b>CreationDate</b> Defines the creation type of the file</li> <li><b>Release</b> Defines the release id of the catalogue file entry</li> <li><b>Issue</b> Defines the issue id of the catalogue file entry</li> <li><b>Description</b> File description</li> <li><b>Comment</b> File comment</li> </ul>
<p>namespace</p>	<p>http://edds.egos.esa/model</p>
<p>children</p>	<p><b>DataObjectid FileName FileType CreationDate Release Issue Description Comment</b></p>
<p>used by</p>	<p>element <b>CatalogueResponse/CatalogueResponseElement</b></p>
<p>annotation</p>	<p>documentation Describes the single catalogue entry</p>

### C.13 complexType DataRequest

<p>diagram</p>	<p><b>Param</b> Defines the Parameter Batch Request</p> <p><b>ParamStatistics</b> Defines the Parameter Statistics Batch Request</p> <p><b>ParamDefinition</b> Defines the Parameter Definition Batch Request</p> <p><b>ParamPreview</b> Defines the Parameter Preview Batch Request</p> <p><b>SmonParam</b> Defines the SMON Parameter Batch Request</p> <p><b>PktEv</b> Defines the Event Packet batch request.</p> <p><b>PktTm</b> Defines the Telemetry Packet batch request.</p> <p><b>PktTc</b> Defines the Telecommand Packet batch request.</p> <p><b>PktTmStatistics</b> Defines the Packet TM Statistics batch request.</p> <p><b>PktTcStatistics</b> Defines the Packet TC Statistics batch request.</p> <p><b>PktEvStatistics</b> Defines the Packet Ev Statistics batch request.</p> <p><b>PktTmReport</b> Defines the Pkt Tm Mcs Report batch request</p> <p><b>PktTcReport</b> Defines the Pkt Tc Mcs Report batch request</p> <p><b>EventRecordReport</b> Defines the event record report</p> <p><b>PktEvRaw</b> Defines the Event Packet batch request.</p> <p><b>PktTmRaw</b> Defines the Telemetry Packet batch request.</p> <p><b>PktTcRaw</b> Defines the Telecommand Packet batch request.</p> <p><b>PktTmGapReport</b> Defines the Telemetry Gaps Report batch request.</p> <p><b>ArchiveCatalogue</b> Defines the Archive Catalogue batch request</p> <p><b>ArchiveFile</b> Defines the File batch request</p> <p><b>ArchiveSubscription</b> Defines the File subscription request</p> <p><b>OoiRecordReport</b> Defines the Out Of Limit Report Batch Request</p> <p><b>EddsUsageReport</b> Defines the Edds Usage Report Request.</p> <p><b>FileSystemFileCatalogue</b> Request to non-recursively list all the files in the specified directories</p> <p><b>FileSystemFolderCatalogue</b> Request to recursively list all the subfolders of the specified directories</p> <p><b>FileSystemFile</b> Request the files</p> <p><b>FileSystemSubscription</b> Request the files when they are created or modified.</p>
<p>namespace</p>	<p><a href="http://edds.egos.esa/model">http://edds.egos.esa/model</a></p>
<p>children</p>	<p><b>Param ParamStatistics ParamDefinition ParamPreview SmonParam PktEv PktTm PktTc PktTmStatistics PktTcStatistics PktEvStatistics PktTmReport PktTcReport EventRecordReport PktEvRaw PktTmRaw PktTcRaw PktTmGapReport ArchiveCatalogue ArchiveFile ArchiveSubscription OoiRecordReport EddsUsageReport FileSystemFileCatalogue FileSystemFolderCatalogue FileSystemFile FileSystemSubscription</b></p>



	<b>FileSystemFile FileSystemSubscription</b>
used by	elements <b>DataRequest BatchRequest/DataRequest</b>
annotation	documentation Defines the specific data requested in the BatchRequest

### C.14 complexType DataspacesRequest

diagram	<p>The request for available dataspaces for given mission, domain (optional) and request type</p>
namespace	http://edds.egos.esa/model
children	<b>MissionName RequestType</b>
used by	element <b>DataspacesRequest</b>
annotation	documentation The request for available dataspaces for given mission, domain (optional) and request type

### C.15 complexType DefaultFileServerRequest

diagram	<p>The request for the default file server for the specified mission and role</p>
namespace	http://edds.egos.esa/model
children	<b>MissionName RoleName</b>
used by	element <b>DefaultFileServerRequest</b>
annotation	documentation The request for the default file server for the specified mission and role

### C.16 complexType DetailedBehaviourState

diagram	<p>Detailed state</p>
namespace	http://edds.egos.esa/model

children	<b>LimitState StatusState SCCState DeltaState</b>
used by	element <b>BehaviourState/DetailedState</b>
annotation	documentation Detailed state

### C.17 complexType DownloadList

diagram	<p>Defines the job id plus the list of files to download. If the list of files to download is empty, all files will be returned.</p>
namespace	http://edds.egos.esa/model
children	<b>Job FileList</b>
used by	element <b>DownloadList</b>

### C.18 complexType FarcCatalogueRequest

diagram	<p>The request for the FARC catalogue for given mission, domain and folder. If the folder is specified the request will be non-recursive.</p> <p>@deprecated, use CatalogueRequest</p>
namespace	http://edds.egos.esa/model
children	<b>MissionName Domain Folder</b>
used by	element <b>FarcCatalogueRequest</b>
annotation	documentation The request for the FARC catalogue for given mission, domain and folder. If the folder is specified the request will be non-recursive. @deprecated, use CatalogueRequest

### C.19 complexType InterruptPart

diagram	<p>Defines the message the client submits to interrupt a request under execution. Is not meant to be used directly; see child objects CancelPart and SuspendPart instead.</p>
---------	---

namespace	http://edds.egos.esa/model
children	<b>User JobIdPart</b>
used by	complexType <b>CancelPart ResumePart SuspendPart</b>
annotation	documentation Defines the message the client submits to interrupt a request under execution. Is not meant to be used directly; see child objects CancelPart and SuspendPart instead.

## C.20 JobIdPart

diagram	
namespace	http://edds.egos.esa/model
children	<b>Job</b>
used by	elements <b>DeleteDataPart DeleteRequestPart JobIdPart CancelPart/JobIdPart</b>
annotation	documentation Defines the job is plus the job context

## C.21 complexType JobIdPartList

diagram	
namespace	http://edds.egos.esa/model
children	<b>JobIdPart</b>
used by	elements <b>DeleteDataPart DeleteRequestPart JobIdPartList</b>
annotation	documentation Defines a list of jobs

## C.22 complexType JobListIdPart

diagram	
namespace	http://edds.egos.esa/model
children	<b>JobListIdPartElement</b>
used by	element <b>JobListIdPart</b>
annotation	documentation JobId list

## C.23 complexType ListString

diagram	
---------	--

namespace	http://edds.egos.esa/model
children	<a href="#">ListElement</a>
used by	element <a href="#">ListString</a>
annotation	documentation A list of String values

### C.24 PacketStatisticsResponse

diagram	
namespace	http://edds.egos.esa/model
children	DateOfFirstPacket NumberOfPackets DateOfLastPacket DataVolumeSize
used by	element <b>Response/PacketStatisticsResponse</b>
annotation	documentation The statistics for the packets requested

### C.25 complexType Param

diagram	
namespace	http://edds.egos.esa/model

type	extension of <b>DataRequestBase</b>
properties	base <b>DataRequestBase</b>
children	<b>RequestPostProcessing Delivery ParamTmFilter ParamTmFormat</b>
used by	elements <b>Param DataRequest/Param</b>
annotation	documentation Defines the Parameter data request

### C.26 complexType ParamDefinition

diagram	
namespace	http://edds.egos.esa/model
type	extension of <b>DataRequestBase</b>
properties	base <b>DataRequestBase</b>
children	<b>RequestPostProcessing Delivery ParamDefinitionFormat</b>
used by	elements <b>ParamDefinition DataRequest/ParamDefinition</b>
annotation	documentation Defines the Parameter Definition data request

### C.27 complexType ParamDefinitionList

diagram	
namespace	http://edds.egos.esa/model
children	<b>ParamDefinitionListElement</b>
used by	element <b>ParamDefinitionResponse/ParamDefinitionList</b>

### C.28 complexType ParamDefinitionListElement

diagram	<pre> classDiagram     class ParamDefinitionListElement {         Name         Description         Unit         Type         Active     }             </pre>
namespace	<a href="http://edds.egos.esa/model">http://edds.egos.esa/model</a>
children	<b>Name Description Unit Type Active</b>
used by	elements <b>ParamDefinitionListElement ParamDefinitionList/ParamDefinitionListElement</b>

### C.29 complexType ParamDefinitionResponse

diagram	<pre> classDiagram     class ParamDefinitionResponse {         ParamDefinitionList     }             </pre> <p>Defines the list of parameters defined in the DARC</p>
namespace	<a href="http://edds.egos.esa/model">http://edds.egos.esa/model</a>
children	<b>ParamDefinitionList</b>
used by	element <b>Response/ParamDefinitionResponse</b>

### C.30 complexType ParamPacketInstance

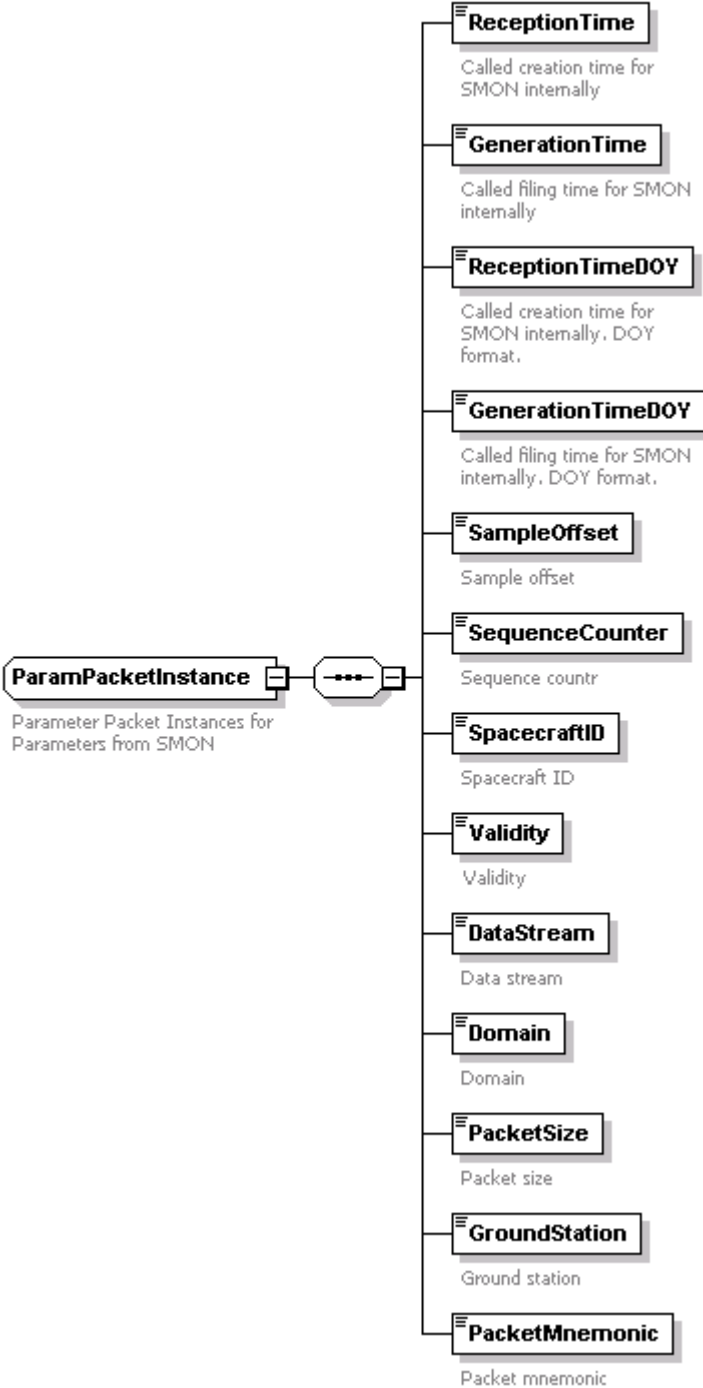
<p>diagram</p>	
<p>namespace</p>	<p><a href="http://edds.egos.esa/model">http://edds.egos.esa/model</a></p>
<p>children</p>	<p><b>ReceptionTime GenerationTime ReceptionTimeDOY GenerationTimeDOY SampleOffset SequenceCounter SpacecraftID Validity DataStream Domain PacketSize GroundStation PacketMnemonic</b></p>
<p>used by</p>	<p>elements <b>ParamPacketInstances/PacketInstance ParamPacketInstance</b></p>
<p>annotation</p>	<p>documentation Parameter Packet Instances for Parameters from SMON</p>

### C.31 complexType ParamPacketInstances

diagram	
namespace	http://edds.egos.esa/model
children	<b>PacketInstance</b>
used by	element <b>SMONParamSampleListElement/ParamPacketInstances</b>
annotation	documentation Parameter Packet Instances for Parameters from SMON

### C.32 complexType ParamPreview

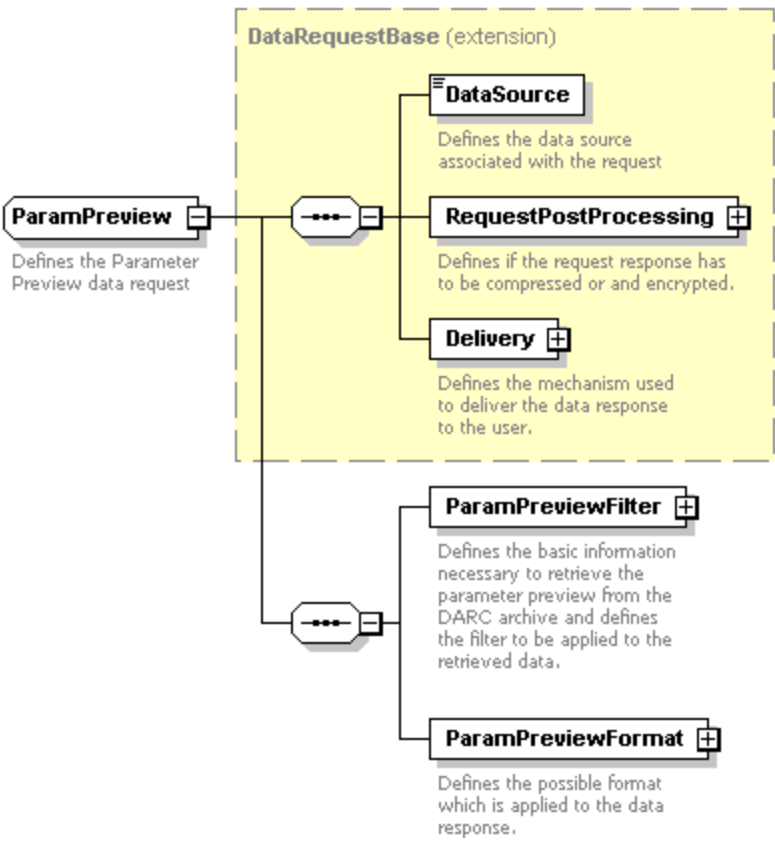
diagram	
namespace	http://edds.egos.esa/model
type	extension of <b>DataRequestBase</b>
properties	base <b>DataRequestBase</b>
children	<b>RequestPostProcessing Delivery ParamPreviewFilter ParamPreviewFormat</b>
used by	elements <b>ParamPreview DataRequest/ParamPreview</b>
annotation	documentation Defines the Parameter Preview data request



### C.33 complexType ParamPreviewList

diagram	
namespace	http://edds.egos.esa/model
children	ParamPreviewListElement
used by	element ParamPreviewResponse/ParamPreviewList

### C.34 complexType ParamPreviewListElement

diagram	
namespace	http://edds.egos.esa/model
children	Name Description NumberOfSamples DateOfFirstUpdate DateOfLastUpdate
used by	elements ParamPreviewListElement ParamPreviewList/ParamPreviewListElement

### C.35 complexType ParamPreviewResponse

diagram	
namespace	http://edds.egos.esa/model
children	ParamPreviewList
used by	element Response/ParamPreviewResponse

### C.36 complexType ParamRepresentationSample

<p>diagram</p>	
<p>namespace</p>	<p>http://edds.egos.esa/model</p>
<p>children</p>	<p><b>RepresentationName SampleTime SampleTimeDOY Value Validity BehaviourStates</b></p>
<p>used by</p>	<p>elements <b>ParamRepresentationSample ParamRepresentationSamples/ParamRepresentationSample</b></p>
<p>annotation</p>	<p>documentation Parameter representation sample</p>

### C.37 complexType ParamRepresentationSamples

<p>diagram</p>	
<p>namespace</p>	<p>http://edds.egos.esa/model</p>
<p>children</p>	<p><b>ParamRepresentationSample</b></p>
<p>used by</p>	<p>element <b>SMONParamSampleListElement/ParamRepresentationSamples</b></p>
<p>annotation</p>	<p>documentation Parameter representation samples from SMON</p>

### C.38 complexType ParamResponse

<p>diagram</p>	<p><b>ParamResponse</b> Defines the XML response returned on Parameter Batch Requests</p> <ul style="list-style-type: none"> <li><b>ParamSampleList</b> Defines list of parameter samples</li> <li><b>MinimumThreshold</b> Minimum threshold used for filtering (needed for TDRS spreadsheet format)</li> <li><b>MaximumThreshold</b> Maximum threshold used for filtering(needed for TDRS spreadsheet format)</li> <li><b>User</b> The username of the user submitting the request (needed for TDRS spreadsheet format)</li> <li><b>RetrievalStart</b> The retrieval start time (needed for TDRS spreadsheet format)</li> <li><b>RetrievalStartDOY</b> The retrieval start time in DOY format (needed for TDRS spreadsheet format)</li> <li><b>RetrievalStop</b> The retrieval end time (needed for TDRS spreadsheet format)</li> <li><b>RetrievalStopDOY</b> The retrieval stop time in DOY format (needed for TDRS spreadsheet format)</li> </ul>
<p>namespace</p>	<p>http://edds.egos.esa/model</p>
<p>children</p>	<p><b>ParamSampleList</b> <b>MinimumThreshold</b> <b>MaximumThreshold</b> <b>User</b> <b>RetrievalStart</b> <b>RetrievalStartDOY</b> <b>RetrievalStop</b> <b>RetrievalStopDOY</b></p>
<p>used by</p>	<p>element <b>Response/ParamResponse</b></p>
<p>annotation</p>	<p>documentation Defines the XML response returned on Parameter Batch Requests</p>

### C.39 complexType ParamSampleList

<p>diagram</p>	<p><b>ParamSampleList</b> Archive file filter descriptor</p> <p><b>ParamSampleListElement</b> Defines the parameter sample element</p>
<p>namespace</p>	<p>http://edds.egos.esa/model</p>
<p>children</p>	<p><b>ParamSampleListElement</b></p>

used by	element <b>ParamResponse/ParamSampleList</b>
annotation	documentation Defines the list of parameter samples

### C.40 complexType ParamSampleListElement

<p>diagram</p>	<p><b>TimeStampAsciiA</b> Parameter time stamp as CCSDS AsciiA (yyyy-mm-ddThh:mm:ss.mmm)</p> <p><b>TimeStampAsciiB</b> Parameter time stamp as CCSDS AsciiB (yyyy-dddThh:mm:ss.mmm)</p> <p><b>StorageTimeStampAsciiA</b> Time that the parameter sample is stored in the DARC (time written to the buffer) as CCSDS AsciiA (yyyy-mm-ddThh:mm:ss.mmm). Not present when saving a DARC parameter stream.</p> <p><b>StorageTimeStampAsciiB</b> Time that the parameter sample is stored in the DARC (time written to the buffer) as CCSDS AsciiB (yyyy-dddThh:mm:ss.mmm). Not present when saving a DARC parameter stream.</p> <p><b>Name</b> Parameter Name</p> <p><b>Description</b> Parameter Description</p> <p><b>Unit</b> Parameter Engineering unit</p> <p><b>Validity</b> Parameter Engineering validity</p> <p><b>EngineeringValue</b> Parameter Eng Value</p> <p><b>Type</b> Parameter Type</p> <p><b>ParentId</b> The parent ID of the TM parameter sample. For SCOS sources, this would be the SPID</p> <p><b>ParentGenTimeAsciiA</b> The parent generation time as CCSDS AsciiA (yyyy-mm-ddThh:mm:ss.mmm). For SCOS sources, this would be the packet generation time</p> <p><b>ParentGenTimeAsciiB</b> The parent generation time as CCSDS AsciiB (yyyy-dddThh:mm:ss.mmm). For SCOS sources, this would be the packet generation time</p> <p><b>RawValue</b> Parameter Raw Value</p> <p><b>RawValueType</b> The type of the raw value</p>
<p>namespace</p>	<p><a href="http://edds.egos.esa/model">http://edds.egos.esa/model</a></p>
<p>children</p>	<p><b>TimeStampAsciiA</b> <b>TimeStampAsciiB</b> <b>StorageTimeStampAsciiA</b> <b>StorageTimeStampAsciiB</b> <b>Name</b> <b>Description</b> <b>Unit</b> <b>Validity</b> <b>EngineeringValue</b> <b>Type</b> <b>ParentId</b> <b>ParentGenTimeAsciiA</b> <b>ParentGenTimeAsciiB</b> <b>RawValue</b></p>

	<b>RawValueType</b>
used by	elements <b>ParamSampleListElement ParamSampleList/ParamSampleListElement</b>

### C.41 complexType ParamStatisticListElement

diagram													
namespace	http://edds.egos.esa/model												
children	<b>StatisticsRecord</b>												
used by	element <b>ParamStatisticsList/ParamStatisticListElement</b>												
attributes	<table border="1"> <thead> <tr> <th>Name</th> <th>Type</th> <th>Use</th> <th>Default</th> <th>Fixed</th> <th>annotation</th> </tr> </thead> <tbody> <tr> <td><a href="#">name</a></td> <td><b>xs:string</b></td> <td></td> <td></td> <td></td> <td></td> </tr> </tbody> </table>	Name	Type	Use	Default	Fixed	annotation	<a href="#">name</a>	<b>xs:string</b>				
Name	Type	Use	Default	Fixed	annotation								
<a href="#">name</a>	<b>xs:string</b>												
annotation	documentation A list of statistics for a particular parameter												

### C.42 complexType ParamStatistics

diagram	
namespace	http://edds.egos.esa/model
type	extension of <b>DataRequestBase</b>
properties	base <b>DataRequestBase</b>

children	<b>RequestPostProcessing Delivery ParamStatisticsFilter ParamStatisticsFormat</b>
used by	elements <b>ParamStatistics DataRequest/ParamStatistics</b>
annotation	documentation Defines the Parameter Statistics data request

### C.43 complexType *ParamStatisticsList*

diagram	<p>A list of parameters with all the associated statistics for the time period requested</p>
namespace	http://edds.egos.esa/model
children	<b>ParamStatisticListElement</b>
used by	element <b>ParamStatisticsResponse/ParamStatisticList</b>
annotation	documentation A list of parameters with all the associated statistics for the time period requested

### C.44 complexType *ParamStatisticsResponse*

diagram	<p>Defines the list of parameters statistics as defined in the DARC</p>
namespace	http://edds.egos.esa/model
children	<b>ParamStatisticList</b>
used by	element <b>Response/ParamStatisticsResponse</b>

### C.45 complexType PktEv

<p>diagram</p>	<pre> classDiagram     class PktEv {         +     }     class DataRequestBase {         +DataSource         +RequestPostProcessing         +Delivery     }     class DataSource {         +     }     class RequestPostProcessing {         +     }     class Delivery {         +     }     class EvPacketFilter {         +     }     class PacketFormat {         +     }     PktEv -- &gt; DataRequestBase     PktEv -- EvPacketFilter     PktEv -- PacketFormat     </pre> <p><b>DataRequestBase (extension)</b></p> <ul style="list-style-type: none"> <li><b>DataSource</b>: Defines the data source associated with the request</li> <li><b>RequestPostProcessing</b>: Defines if the request response has to be compressed or and encrypted.</li> <li><b>Delivery</b>: Defines the mechanism used to deliver the data response to the user.</li> </ul> <p><b>PktEv</b>: Defines the Event Packet data request</p> <ul style="list-style-type: none"> <li><b>EvPacketFilter</b>: Defines the basic information necessary to retrieve the data from the PARC archive and defines the filter to be applied to the retrieved data.</li> <li><b>PacketFormat</b>: Defines the possible format which is applied to the data response.</li> </ul>
<p>namespace</p>	<p>http://edds.egos.esa/model</p>
<p>type</p>	<p>extension of <b>DataRequestBase</b></p>
<p>properties</p>	<p>base <b>DataRequestBase</b></p>
<p>children</p>	<p><b>RequestPostProcessing Delivery EvPacketFilter PacketFormat</b></p>
<p>used by</p>	<p>elements <b>PktEv DataRequest/PktEv</b></p>
<p>annotation</p>	<p>documentation Defines the Event Packet data request</p>



### C.46 complexType PktEvRaw

<p>diagram</p>	<pre> classDiagram     class PktEvRaw {         +     }     class DataRequestBase {         +     }     class DataSource {         +     }     class RequestPostProcessing {         +     }     class Delivery {         +     }     class RawPacketFilter {         +     }     class PacketFormat {         +     }     PktEvRaw -- &gt; DataRequestBase     DataSource -- &gt; DataRequestBase     RequestPostProcessing -- &gt; DataRequestBase     Delivery -- &gt; DataRequestBase     RawPacketFilter -- &gt; PktEvRaw     PacketFormat -- &gt; PktEvRaw     </pre> <p><b>DataRequestBase (extension)</b></p> <ul style="list-style-type: none"> <li><b>DataSource</b>: Defines the data source associated with the request</li> <li><b>RequestPostProcessing</b>: Defines if the request response has to be compressed or and encrypted.</li> <li><b>Delivery</b>: Defines the mechanism used to deliver the data response to the user.</li> </ul> <p><b>PktEvRaw</b>: Defines the Event Packet raw data request, i.e. unprocessed as received from the archive.</p> <ul style="list-style-type: none"> <li><b>RawPacketFilter</b>: Defines the basic information necessary to retrieve the data from the PARC archive</li> <li><b>PacketFormat</b>: Defines the possible format which is applied to the data response.</li> </ul>
<p>namespace</p>	<p>http://edds.egos.esa/model</p>
<p>type</p>	<p>extension of <b>DataRequestBase</b></p>
<p>properties</p>	<p>base DataRequestBase</p>
<p>children</p>	<p><b>RequestPostProcessing Delivery RawPacketFilter PacketFormat</b></p>
<p>used by</p>	<p>elements <b>PktEvRaw DataRequest/PktEvRaw</b></p>
<p>annotation</p>	<p>documentation Defines the Event Packet raw data request, i.e. unprocessed as received from the archive.</p>

### C.47 complexType PktEvStatistics

<p>diagram</p>	<pre> classDiagram     class PktEvStatistics {         +     }     class DataRequestBase {         +DataSource         +RequestPostProcessing         +Delivery     }     class DataSource {         +     }     class RequestPostProcessing {         +     }     class Delivery {         +     }     class EvPacketFilter {         +     }     class PacketStatisticsFormat {         +     }     PktEvStatistics .. &gt; DataRequestBase : extension     PktEvStatistics -- DataSource     PktEvStatistics -- RequestPostProcessing     PktEvStatistics -- Delivery     PktEvStatistics -- EvPacketFilter     PktEvStatistics -- PacketStatisticsFormat     </pre> <p><b>PktEvStatistics</b> Defines the Event Packet statistics data request</p> <p><b>DataRequestBase (extension)</b></p> <ul style="list-style-type: none"> <li><b>DataSource</b> Defines the data source associated with the request</li> <li><b>RequestPostProcessing</b> Defines if the request response has to be compressed or and encrypted.</li> <li><b>Delivery</b> Defines the mechanism used to deliver the data response to the user.</li> </ul> <p><b>EvPacketFilter</b> Defines the basic information necessary to retrieve the data from the PARC archive and defines the filter to be applied to the retrieved data.</p> <p><b>PacketStatisticsFormat</b> Defines the possible format which is applied to the data response.</p>
<p>namespace</p>	<p>http://edds.egos.esa/model</p>
<p>type</p>	<p>extension of <b>DataRequestBase</b></p>
<p>properties</p>	<p>base <b>DataRequestBase</b></p>
<p>children</p>	<p><b>RequestPostProcessing</b> <b>Delivery</b> <b>EvPacketFilter</b> <b>PacketStatisticsFormat</b></p>
<p>used by</p>	<p>elements <b>PktEvStatistics</b> <b>DataRequest/PktEvStatistics</b></p>
<p>annotation</p>	<p>documentation Defines the Event Packet statistics data request</p>

### C.48 complexType PktRawResponse

<p>diagram</p>	<pre> classDiagram     class PktRawResponse {         +     }     class PktRawResponseElement {         +     }     PktRawResponse -- PktRawResponseElement : 0..∞     </pre> <p><b>PktRawResponse</b> Defines the raw packet response data</p> <p><b>PktRawResponseElement</b> Defines the single catalogue entry</p>
<p>namespace</p>	<p>http://edds.egos.esa/model</p>
<p>children</p>	<p><b>PktRawResponseElement</b></p>
<p>used by</p>	<p>element <b>Response/PktRawResponse</b></p>
<p>annotation</p>	<p>documentation Defines the raw packet response data</p>

### C.49 complexType PktRawResponseElement

diagram						
namespace	http://edds.egos.esa/model					
children	<b>Packet</b>					
used by	elements	<b>PktRawResponseElement PktRawResponse/PktRawResponseElement</b>				
attributes	Name	Type	Use	Default	Fixed	annotation
	<a href="#">packetID</a>	<b>xs:long</b>				
annotation	documentation Describes the single catalogue entry					

### C.50 complexType PktTc

diagram						
namespace	http://edds.egos.esa/model					
type	extension of <b>DataRequestBase</b>					
properties	base	<b>DataRequestBase</b>				
children	<b>RequestPostProcessing Delivery TcPacketFilter PacketFormat</b>					
used by	elements	<b>PktTc DataRequest/PktTc</b>				
annotation	documentation Defines the Telecommand Packet data request					

### C.51 complexType PktTcRaw

<p>diagram</p>	<pre> classDiagram     class PktTcRaw {         +DataSource         +RequestPostProcessing         +Delivery         +RawPacketFilter         +PacketFormat     }     class DataRequestBase {         +DataSource         +RequestPostProcessing         +Delivery     }     PktTcRaw -- &gt; DataRequestBase     </pre> <p><b>PktTcRaw</b> Defines the Telecommand Packet raw data request, i.e. unprocessed as received from the archive.</p> <p><b>DataRequestBase (extension)</b></p> <ul style="list-style-type: none"> <li><b>DataSource</b> Defines the data source associated with the request</li> <li><b>RequestPostProcessing</b> Defines if the request response has to be compressed or and encrypted.</li> <li><b>Delivery</b> Defines the mechanism used to deliver the data response to the user.</li> <li><b>RawPacketFilter</b> Defines the basic information necessary to retrieve the data from the PARC archive</li> <li><b>PacketFormat</b> Defines the possible format which is applied to the data response.</li> </ul>
<p>namespace</p>	<p>http://edds.egos.esa/model</p>
<p>type</p>	<p>extension of <b>DataRequestBase</b></p>
<p>properties</p>	<p>base <b>DataRequestBase</b></p>
<p>children</p>	<p><b>RequestPostProcessing Delivery RawPacketFilter PacketFormat</b></p>
<p>used by</p>	<p>elements <b>PktTcRaw DataRequest/PktTcRaw</b></p>
<p>annotation</p>	<p>documentation Defines the Telecommand Packet raw data request, i.e. unprocessed as received from the archive.</p>

### C.52 complexType PktTcStatistics

<p>diagram</p>	<pre> classDiagram     class PktTcStatistics {         +DataSource         +RequestPostProcessing         +Delivery         +TcPacketFilter         +PacketStatisticsFormat     }     class DataRequestBase {         +DataSource         +RequestPostProcessing         +Delivery     }     class DataRequest {     }     PktTcStatistics -- &gt; DataRequestBase     DataRequestBase .. &gt; DataRequest     </pre> <p><b>PktTcStatistics</b> Defines the Telecommand Statistics Packet data request</p> <p><b>DataRequestBase (extension)</b></p> <ul style="list-style-type: none"> <li><b>DataSource</b> Defines the data source associated with the request</li> <li><b>RequestPostProcessing</b> Defines if the request response has to be compressed or and encrypted.</li> <li><b>Delivery</b> Defines the mechanism used to deliver the data response to the user.</li> </ul> <p><b>TcPacketFilter</b> Defines the basic information necessary to retrieve the data from the PARC archive and defines the filter to be applied to the retrieved data.</p> <p><b>PacketStatisticsFormat</b> Defines the possible format which is applied to the data response.</p>
<p>namespace</p>	<p>http://edds.egos.esa/model</p>
<p>type</p>	<p>extension of <b>DataRequestBase</b></p>
<p>properties</p>	<p>base DataRequestBase</p>
<p>children</p>	<p><b>RequestPostProcessing</b> <b>Delivery</b> <b>TcPacketFilter</b> <b>PacketStatisticsFormat</b></p>
<p>used by</p>	<p>elements <b>PktTcStatistics</b> <b>DataRequest/PktTcStatistics</b></p>
<p>annotation</p>	<p>documentation Defines the Telecommand Statistics Packet data request</p>

### C.53 complexType PktTm

<p>diagram</p>	<pre> classDiagram     class PktTm {         +     }     class DataRequestBase {         +     }     class DataSource {         +     }     class RequestPostProcessing {         +     }     class Delivery {         +     }     class TmPacketFilter {         +     }     class PacketFormat {         +     }     PktTm -- &gt; DataRequestBase : extension     PktTm -- DataSource     PktTm -- RequestPostProcessing     PktTm -- Delivery     PktTm -- TmPacketFilter     PktTm -- PacketFormat     </pre> <p><b>PktTm</b> Defines the Telemetry Packet data request</p> <p><b>DataRequestBase (extension)</b></p> <ul style="list-style-type: none"> <li><b>DataSource</b> Defines the data source associated with the request</li> <li><b>RequestPostProcessing</b> Defines if the request response has to be compressed or and encrypted.</li> <li><b>Delivery</b> Defines the mechanism used to deliver the data response to the user.</li> </ul> <ul style="list-style-type: none"> <li><b>TmPacketFilter</b> Defines the basic information necessary to retrieve the data from the PARC archive and defines the filter to be applied to the retrieved data.</li> <li><b>PacketFormat</b> Defines the possible format which is applied to the data response.</li> </ul>
<p>namespace</p>	<p><a href="http://edds.egos.esa/model">http://edds.egos.esa/model</a></p>
<p>type</p>	<p>extension of <b>DataRequestBase</b></p>
<p>properties</p>	<p>base <b>DataRequestBase</b></p>
<p>children</p>	<p><b>RequestPostProcessing Delivery TmPacketFilter PacketFormat</b></p>
<p>used by</p>	<p>elements <b>PktTm DataRequest/PktTm</b></p>
<p>annotation</p>	<p>documentation Defines the Telemetry Packet data request</p>

### C.54 complexType PktTmGapReport

<p>diagram</p>	<pre> graph LR     PktTmGapReport --&gt; DataSource     PktTmGapReport --&gt; RequestPostProcessing     PktTmGapReport --&gt; Delivery     PktTmGapReport --&gt; PktTmGapReportFilter     PktTmGapReport --&gt; PktTmGapReportFormat     </pre> <p><b>PktTmGapReport</b></p> <ul style="list-style-type: none"> <li><b>DataSource</b>: Defines the data source associated with the request</li> <li><b>RequestPostProcessing</b>: Defines if the request response has to be compressed or and encrypted.</li> <li><b>Delivery</b>: Defines the mechanism used to deliver the data response to the user.</li> <li><b>PktTmGapReportFilter</b>: Defines the basic information necessary to retrieve the TM Gap Report</li> <li><b>PktTmGapReportFormat</b>: Defines the possible format which is applied to the data response.</li> </ul>
<p>namespace</p>	<p><a href="http://edds.egos.esa/model">http://edds.egos.esa/model</a></p>
<p>type</p>	<p><a href="#">PktTmGapReport</a></p>
<p>properties</p>	<p>content complex</p>
<p>children</p>	<p><a href="#">DataSource</a> <a href="#">RequestPostProcessing</a> <a href="#">Delivery</a> <a href="#">PktTmGapReportFilter</a> <a href="#">PktTmGapReportFormat</a></p>

**C.55 complexType PktTmGapReportElement**

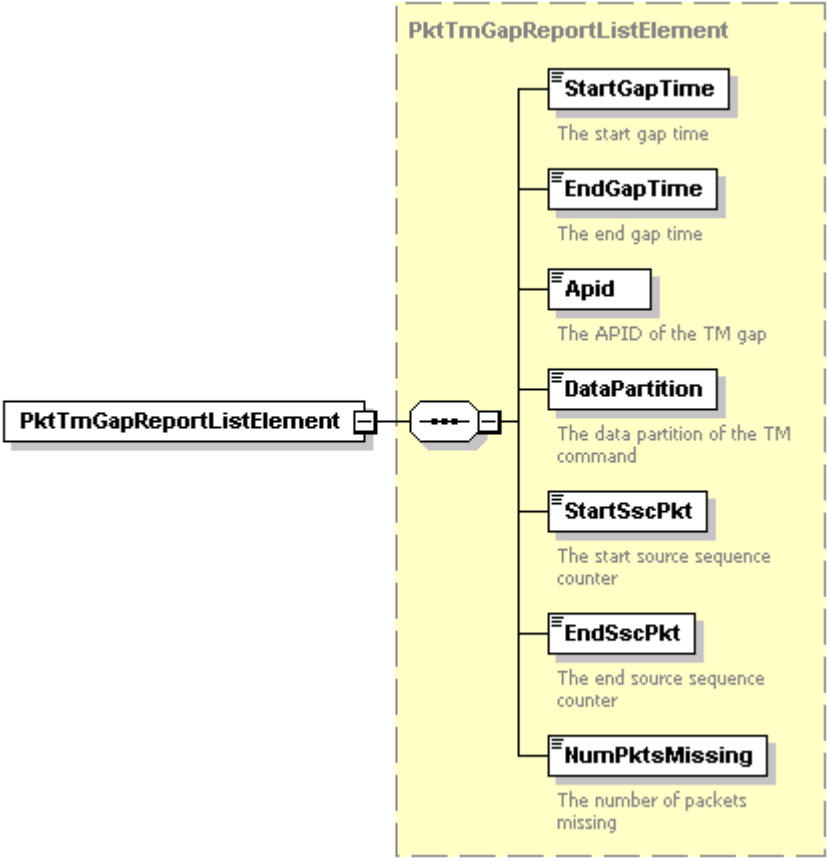
<p>diagram</p>	
<p>namespace</p>	<p><a href="http://edds.egos.esa/model">http://edds.egos.esa/model</a></p>
<p>type</p>	<p><a href="#">PktTmGapReportListElement</a></p>
<p>properties</p>	<p>content complex</p>
<p>children</p>	<p><a href="#">StartGapTime</a> <a href="#">EndGapTime</a> <a href="#">Apid</a> <a href="#">DataPartition</a> <a href="#">StartSscPkt</a> <a href="#">EndSscPkt</a> <a href="#">NumPktsMissing</a></p>



### C.56 complexType PktTmRaw

<p>diagram</p>	<pre> classDiagram     class PktTmRaw {         +DataSource         +RequestPostProcessing         +Delivery         +RawPacketFilter         +PacketFormat     }     class DataRequestBase {         +DataSource         +RequestPostProcessing         +Delivery     }     PktTmRaw .. &gt; DataRequestBase     </pre> <p><b>PktTmRaw</b> Defines the Telemetry Packet raw data request, i.e. unprocessed as received from the archive.</p> <p><b>DataRequestBase (extension)</b></p> <ul style="list-style-type: none"> <li><b>DataSource</b> Defines the data source associated with the request</li> <li><b>RequestPostProcessing</b> Defines if the request response has to be compressed or and encrypted.</li> <li><b>Delivery</b> Defines the mechanism used to deliver the data response to the user.</li> </ul> <p><b>RawPacketFilter</b> Defines the basic information necessary to retrieve the data from the PARC archive</p> <p><b>PacketFormat</b> Defines the possible format which is applied to the data response.</p>
<p>namespace</p>	<p>http://edds.egos.esa/model</p>
<p>type</p>	<p>extension of <b>DataRequestBase</b></p>
<p>properties</p>	<p>base DataRequestBase</p>
<p>children</p>	<p><b>RequestPostProcessing Delivery RawPacketFilter PacketFormat</b></p>
<p>used by</p>	<p>elements <b>PktTmRaw DataRequest/PktTmRaw</b></p>
<p>annotation</p>	<p>documentation Defines the Telemetry Packet raw data request, i.e. unprocessed as received from the archive.</p>

### C.57 complexType PktTmStatistics

<p>diagram</p>	<pre> classDiagram     class PktTmStatistics {         +DataSource         +RequestPostProcessing         +Delivery         +TmPacketFilter         +PacketStatisticsFormat     }     class DataRequestBase {         +DataSource         +RequestPostProcessing         +Delivery         +TmPacketFilter         +PacketStatisticsFormat     }     PktTmStatistics -- &gt; DataRequestBase     PktTmStatistics o-- RequestPostProcessing     PktTmStatistics o-- TmPacketFilter     RequestPostProcessing o-- DataSource     RequestPostProcessing o-- Delivery     RequestPostProcessing o-- PacketStatisticsFormat     TmPacketFilter o-- PacketStatisticsFormat     </pre> <p><b>PktTmStatistics</b> Defines the Telemetry Packet Statistics data request</p> <p><b>DataRequestBase (extension)</b></p> <ul style="list-style-type: none"> <li><b>DataSource</b> Defines the data source associated with the request</li> <li><b>RequestPostProcessing</b> Defines if the request response has to be compressed or and encrypted.</li> <li><b>Delivery</b> Defines the mechanism used to deliver the data response to the user.</li> <li><b>TmPacketFilter</b> Defines the basic information necessary to retrieve the data from the PARC archive and defines the filter to be applied to the retrieved data.</li> <li><b>PacketStatisticsFormat</b> Defines the possible format which is applied to the data response.</li> </ul>
<p>namespace</p>	<p>http://edds.egos.esa/model</p>
<p>type</p>	<p>extension of <b>DataRequestBase</b></p>
<p>properties</p>	<p>base <b>DataRequestBase</b></p>
<p>children</p>	<p><b>RequestPostProcessing</b> <b>Delivery</b> <b>TmPacketFilter</b> <b>PacketStatisticsFormat</b></p>
<p>used by</p>	<p>elements <b>PktTmStatistics</b> <b>DataRequest/PktTmStatistics</b></p>
<p>annotation</p>	<p>documentation Defines the Telemetry Packet Statistics data request</p>

### C.58 complexType RequestMessagePart

<p>diagram</p>	<pre> classDiagram     class RequestMessagePart {         +ContextPart         +BatchRequest     }     RequestMessagePart o-- ContextPart     RequestMessagePart o-- BatchRequest     </pre> <p><b>RequestMessagePart</b> Defines the message the client submit to server</p> <ul style="list-style-type: none"> <li><b>ContextPart</b> Defines the context of the request.</li> <li><b>BatchRequest</b> Defines the batch request.</li> </ul>
<p>namespace</p>	<p>http://edds.egos.esa/model</p>
<p>children</p>	<p><b>ContextPart</b> <b>BatchRequest</b></p>
<p>used by</p>	<p>element <b>RequestMessagePart</b></p>
<p>annotation</p>	<p>documentation Defines the message the client submit to server</p>

### C.59 complexType Response

<p>diagram</p>	<div style="display: flex; flex-direction: column; gap: 10px;"> <div> <p><b>PacketStatisticsResponse</b> </p> <p>0..∗</p> <p>Defines the Packet Statistics XML response</p> </div> <div> <p><b>ParamStatisticsResponse</b> </p> <p>0..∗</p> <p>Defines the Parameter Statistics XML response</p> </div> <div> <p><b>ParamPreviewResponse</b> </p> <p>0..∗</p> <p>Defines the Parameter Preview XML response</p> </div> <div> <p><b>ParamDefinitionResponse</b> </p> <p>0..∗</p> <p>Defines the Parameter Definition XML response</p> </div> <div> <p><b>ParamResponse</b> </p> <p>0..∗</p> <p>Defines the response to the Parameter Batch Request</p> </div> <div> <p><b>PktTcReportResponse</b> </p> <p>0..∗</p> <p>Defines the Packet TC Report XML response</p> </div> <div> <p><b>PktTmReportResponse</b> </p> <p>0..∗</p> <p>Defines the Packet TM Report XML response</p> </div> <div> <p><b>PktTmGapReportResponse</b> </p> <p>0..∗</p> <p>Defines the Packet TM Gap Report XML response</p> </div> <div> <p><b>EventRecordReportResponse</b> </p> <p>0..∗</p> <p>Defines the response to the Event Record Report</p> </div> <div> <p><b>PktRawResponse</b> </p> <p>0..∗</p> <p>Defines the Packet Raw XML response</p> </div> <div> <p><b>CatalogueResponse</b> </p> <p>0..∗</p> <p>Defines the Catalogue XML response</p> </div> <div> <p><b>OolDataReportResponse</b> </p> <p>0..∗</p> <p>Defines the OOL Data Report XML response</p> </div> <div> <p><b>EddsUsageReportResponse</b> </p> <p>0..∗</p> <p>Defines the EDDS Usage Report XML response</p> </div> <div> <p><b>FileSystemFileCatalogueRespo...</b> </p> <p>0..∗</p> <p>Defines the file system catalogue listing XML response</p> </div> <div> <p><b>FileSystemFolderCatalogueRes...</b> </p> <p>0..∗</p> <p>Defines the file system structure listing XML response</p> </div> </div>
<p>namespace</p>	<p>http://edds.egos.esa/model</p>
<p>children</p>	<p><b>PacketStatisticsResponse ParamStatisticsResponse ParamPreviewResponse ParamDefinitionResponse ParamResponse PktTcReportResponse PktTmReportResponse PktTmGapReportResponse EventRecordReportResponse PktRawResponse CatalogueResponse</b></p>

	<b>OoiDataReportResponse EddsUsageReportResponse FileSystemFileCatalogueResponse FileSystemFolderCatalogueResponse</b>
used by	element <b>ResponsePart/Response</b>
annotation	documentation Defines the possible batch request responses

### C.60 complexType ResponseData

diagram	<p>The response files of a request</p> <p>The response files of a request 1..∞</p>
namespace	http://edds.egos.esa/model
children	<b>ResponseDataElement</b>
used by	element <b>ResponseData</b>
annotation	documentation The response files of a request

### C.61 complexType ResponseDataElement

diagram	<p>The response files of a request</p> <p><b>FileName</b> The name of the original file</p> <p><b>Response</b> The response file</p>
namespace	http://edds.egos.esa/model
children	<b>FileName Response</b>
used by	element <b>ResponseData/ResponseDataElement</b>
annotation	documentation The response files of a request

### C.62 complexType ResponsePart

diagram	<p>Defines the XML response returned on user request</p> <p>Defines the response details</p>
namespace	http://edds.egos.esa/model
children	<b>Response</b>
used by	element <b>ResponsePart</b>
annotation	documentation Defines the XML response returned on user request

### C.63 complexType ResumePart

diagram	<p>ResumePart</p> <p>Defines the message the client submits to resume a suspended or failed request</p> <p>InterruptPart (extension)</p> <p>User</p> <p>User details</p> <p>JobIdPart</p> <p>Defines the id of the request to be interrupted</p>
namespace	http://edds.egos.esa/model
type	extension of <b>InterruptPart</b>
properties	base <b>InterruptPart</b>
children	<b>User JobIdPart</b>
used by	elements <b>ResumePart ResumePartList/ResumePart</b>
annotation	documentation Defines the message the client submits to resume a suspended or failed request

### C.64 complexType ResumePartList

diagram	<p>ResumePartList</p> <p>Defines a list of resume requests</p> <p>ResumePart</p> <p>0..∞</p>
namespace	http://edds.egos.esa/model
children	<b>ResumePart</b>
used by	element <b>ResumePartList</b>
annotation	documentation Defines a list of resume requests

### C.65 complexType SMONParam

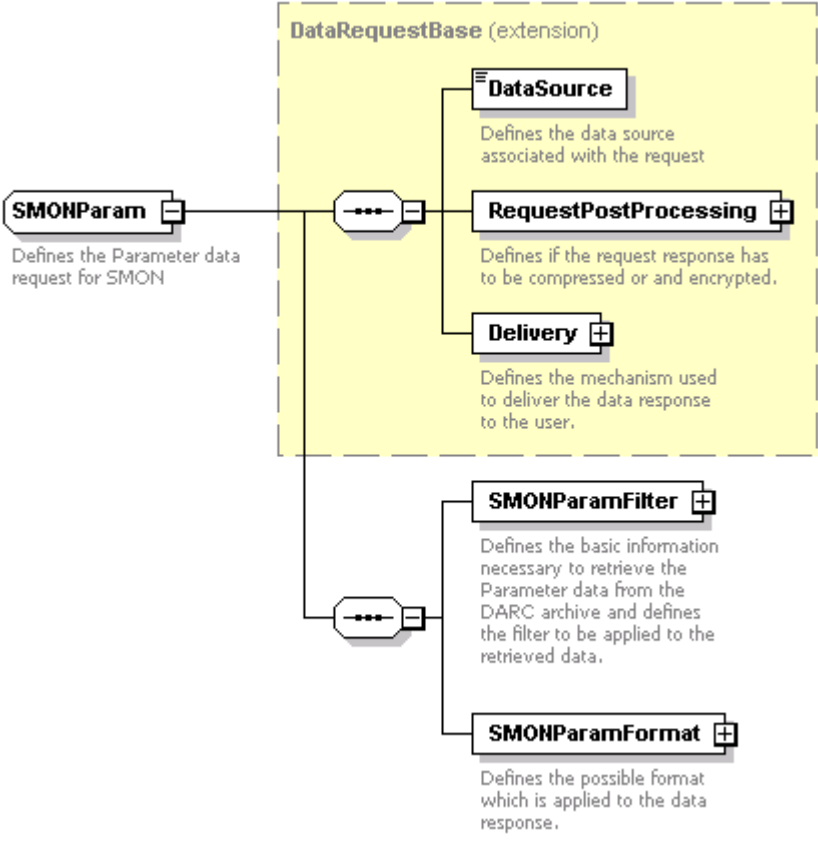
<p>diagram</p>	
<p>namespace</p>	<p>http://edds.egos.esa/model</p>
<p>children</p>	<p><b>DataSource RequestPostProcessing Delivery SMONParamFilter SMONParamFormat</b></p>
<p>used by</p>	<p>elements <b>SMONParam DataRequest/SmonParam</b></p>
<p>annotation</p>	<p>documentation Defines the Parameter data request for SMON</p>

### C.66 complexType SMONParamResponse

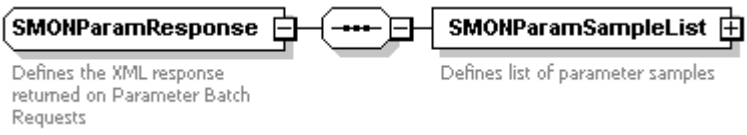
<p>diagram</p>	
<p>namespace</p>	<p>http://edds.egos.esa/model</p>
<p>children</p>	<p><b>SMONParamSampleList</b></p>
<p>annotation</p>	<p>documentation Defines the XML response returned on Parameter Batch Requests</p>

### C.67 complexType SMONParamResponseList

<p>diagram</p>	
<p>namespace</p>	<p>http://edds.egos.esa/model</p>
<p>children</p>	<p><b>SMONParamSampleListElement</b></p>

used by	element <b>SMONParamResponse/SMONParamSampleList</b>
annotation	documentation Defines the list of parameter samples

**C.68 complexType SMONParamResponseListElement**

diagram	
namespace	http://edds.egos.esa/model
children	<b>Name CalibID PacketInstances ParamRepresentationSamples</b>
used by	elements <b>SMONParamSampleListElement SMONParamSampleList/SMONParamSampleListElement</b>

**C.69 complexType StatisticsRecord**

diagram	
namespace	http://edds.egos.esa/model
children	<b>StatStartTime StorageTime Min Max Average StdDev NolInvalid NoValid</b>
used by	element <b>ParamStatisticListElement/StatisticsRecord</b>
annotation	documentation The statistics for a particular parameter for a time period

**C.70 complexType SuspendPart**

diagram	
namespace	http://edds.egos.esa/model
type	extension of <b>InterruptPart</b>
properties	base <b>InterruptPart</b>
children	<b>User JobIdPart</b>
used by	elements <b>SuspendPart SuspendPartList/SuspendPart</b>
annotation	documentation Defines the message the client submits to suspend a request under execution

**C.71 complexType SuspendPartList**

diagram	
namespace	http://edds.egos.esa/model
children	<b>SuspendPart</b>
used by	element <b>SuspendPartList</b>
annotation	documentation Defines a list of suspend requests

**C.72 complexType TransformationsList**

diagram	
namespace	http://edds.egos.esa/model
children	<b>TransformationName</b>
used by	element <b>TransformationsList</b>
annotation	documentation The list of allowed transformation names



### C.73 complexType TransformationsRequest

diagram	<p>The request for available XSL Transformations for given mission and request type</p>
namespace	http://edds.egos.esa/model
children	<b>MissionName RequestType</b>
used by	element <b>TransformationsRequest</b>
annotation	documentation The request for available XSL Transformations for given mission and request type

### C.74 complexType Validity

diagram	<p>Parameter validity</p> <p>Validity value</p> <p>Validity details</p>
namespace	http://edds.egos.esa/model
children	<b>Validity ValidityDetails</b>
used by	element <b>ParamRepresentationSample/Validity</b>
annotation	documentation Parameter validity

## Appendix D Common Data Types

This section of the document describes the common complex types used for all services as defined in the common.xsd file.

### D.1 complexType ApidList

diagram	
namespace	http://edds.egos.esa/model
children	<b>ApidListElement</b>
annotation	documentation A list of APID

### D.2 complexType Completion

diagram	
namespace	http://edds.egos.esa/model
children	<b>AmountOfData Percentage FilteredSamples RetrievedSamples ResponseFiles</b>

### D.3 complexType ContextPart

diagram	
namespace	http://edds.egos.esa/model
children	<b>MissionId DomainId PrivacyTag</b>
annotation	documentation Defines the context made of the id of the mission and the interested domains.

### D.4 complexType DeliveryRange

<p>diagram</p>	<p><b>DeliveryRange</b></p> <p>If the DeliveryRange is None, the parameter will always be added. If the DeliveryRange is SampleNumber or SampleTime, further checking needs to be performed.</p> <p><b>SampleNumber</b></p> <p>For SampleNumber, we only add every nth parameter, where n is the value within SampleNumber.</p> <p><b>SampleTime</b></p> <p>For SampleTime, we only add the parameter if it falls within the frequency specified within SampleTime.</p> <p><b>None</b></p> <p>No further checking</p>
<p>namespace</p>	<p>http://edds.egos.esa/model</p>
<p>children</p>	<p><b>SampleNumber SampleTime None</b></p>
<p>annotation</p>	<p>documentation If the DeliveryRange is None, the parameter will always be added. If the DeliveryRange is SampleNumber or SampleTime, further checking needs to be performed.</p>

### D.5 complexType DomainList

<p>diagram</p>	<p><b>DomainList</b></p> <p><b>DomainListElement</b></p> <p>0..∞</p>
<p>namespace</p>	<p>http://edds.egos.esa/model</p>
<p>children</p>	<p><b>DomainListElement</b></p>

### D.6 complexType EmailList

<p>diagram</p>	<p><b>EmailList</b></p> <p>Defines multiple e-mail address</p> <p><b>EmailListElement</b></p> <p>Single E-mail address</p> <p>0..∞</p>
<p>namespace</p>	<p>http://edds.egos.esa/model</p>
<p>children</p>	<p><b>EmailListElement</b></p>
<p>annotation</p>	<p>documentation Defines multiple e-mail address</p>

### D.7 complexType PacketName

diagram	
namespace	http://edds.egos.esa/model
children	<b>Spid Apid Type SubType Pi1 Pi2</b>
used by	element <b>PacketNameList/PacketNameListElement</b>

### D.8 complexType PacketNameList

diagram	
namespace	http://edds.egos.esa/model
children	<b>PacketNameListElement</b>
annotation	documentation List of generated files

### complexType ParamNameList

diagram	
namespace	http://edds.egos.esa/model
children	<b>ParamNameListElement</b>
annotation	documentation A list of parameter names

**D.9 complexType Pi1List**

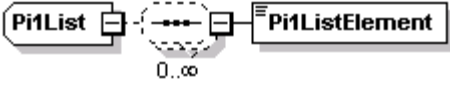
diagram	
namespace	http://edds.egos.esa/model
children	<b>Pi1ListElement</b>

**D.10 complexType Pi2List**

diagram	
namespace	http://edds.egos.esa/model
children	<b>Pi2ListElement</b>

**D.11 complexType RequestPostProcessing**

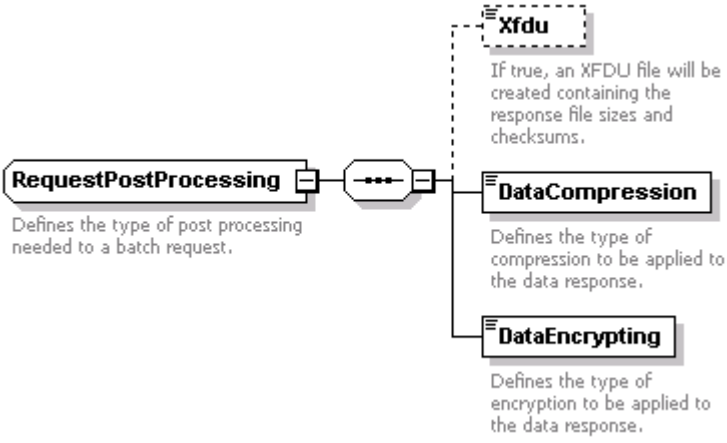
diagram	 <p><b>RequestPostProcessing</b> Defines the type of post processing needed to a batch request.</p> <p><b>Xfdu</b> If true, an XFDU file will be created containing the response file sizes and checksums.</p> <p><b>DataCompression</b> Defines the type of compression to be applied to the data response.</p> <p><b>DataEncrypting</b> Defines the type of encryption to be applied to the data response.</p>
namespace	http://edds.egos.esa/model
children	<b>DataCompression DataEncrypting</b>
annotation	documentation Defines the type of post processing needed to a batch request.

**D.12 complexType ResponseFiles**

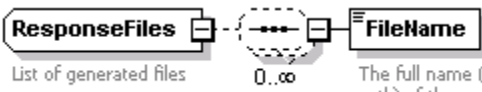
diagram	 <p><b>ResponseFiles</b> List of generated files</p> <p><b>FileName</b> The full name (including path) of the generated files</p>
namespace	http://edds.egos.esa/model
children	<b>FileName</b>
used by	element <b>Completion/ResponseFiles</b>

annotation	documentation List of generated files
------------	--

### D.13 complexType SpidList

diagram	<p>Not supported by the DARC</p>
namespace	http://edds.egos.esa/model
children	<b>SpidListElement</b>
annotation	documentation Not supported by the DARC

### D.14 complexType SubTypeList

diagram	<p>A list of SubType element</p>
namespace	http://edds.egos.esa/model
children	<b>SubTypeListElement</b>
annotation	documentation A list of SubType element

### D.15 complexType Time

diagram	<p><b>Time</b> The time in ASCII A (DMY) format</p> <p><b>DOYTime</b> The time in ASCII B (DOY) format</p>
namespace	http://edds.egos.esa/model
children	<b>Time DOYTime</b>

### D.16 complexType TimeChoice

diagram	
namespace	http://edds.egos.esa/model
children	TimeRange Last Next
annotation	documentation Define the time choice to be applied for the Archive filter

### D.17 complexType TimeRange

diagram	
namespace	http://edds.egos.esa/model
children	StartTime StartDOYTime RelativeStartTime EndTime EndDOYTime Duration
used by	element EddsUsageReportFilter/TimeRange EvPacketFilter/TimeRange ParamPreviewFilter/TimeRange ParamStatisticsFilter/TimeRange ParamTmFilter/TimeRange OolDataReportFilter/TimeRange TcPacketFilter/TimeRange TmPacketFilter/TimeRange RawPacketFilter/TimeRange TimeChoice/TimeRange

### D.18 complexType TimeWindow

diagram	<p>The diagram shows a complex type <b>TimeWindow</b> with two children: <b>StartTime</b> and <b>EndTime</b>. The <b>StartTime</b> child is described as: "The start time. The value has to be in the format: [-]CCYY-MM-DDThh:mm:ss[Z](+ -)hh:mm". The <b>EndTime</b> child is described as: "The end time. The value has to be in the format: [-]CCYY-MM-DDThh:mm:ss[Z](+ -)hh:mm".</p>
namespace	http://edds.egos.esa/model
children	<b>StartTime EndTime</b>
used by	element <b>TimeWindow</b>

### D.19 complexType User

diagram	<p>The diagram shows a complex type <b>User</b> with two children: <b>UserName</b> and <b>Role</b>. The <b>User</b> type is described as: "Defines the user information associate with the request". The <b>UserName</b> child is described as: "User name". The <b>Role</b> child is described as: "User role. Needed for batch requests, but not user management requests.".</p>
namespace	http://edds.egos.esa/model
children	<b>UserName Role</b>
annotation	documentation Defines the user information associate with the request

### D.20 simpleType DataAccessDataElement

namespace	http://edds.egos.esa/model																														
type	restriction of <b>xs:string</b>																														
properties	base <b>xs:string</b>																														
facets	<table border="0"> <tr> <td>Kind</td> <td>Value</td> <td>annotation</td> </tr> <tr> <td>enumeration</td> <td>Param</td> <td></td> </tr> <tr> <td>enumeration</td> <td>ParamStatistics</td> <td></td> </tr> <tr> <td>enumeration</td> <td>ParamDefinition</td> <td></td> </tr> <tr> <td>enumeration</td> <td>ParamPreview</td> <td></td> </tr> <tr> <td>enumeration</td> <td>SmonParam</td> <td></td> </tr> <tr> <td>enumeration</td> <td>PktEv</td> <td></td> </tr> <tr> <td>enumeration</td> <td>PktTm</td> <td></td> </tr> <tr> <td>enumeration</td> <td>PktTc</td> <td></td> </tr> <tr> <td>enumeration</td> <td>PktTmStatistics</td> <td></td> </tr> </table>	Kind	Value	annotation	enumeration	Param		enumeration	ParamStatistics		enumeration	ParamDefinition		enumeration	ParamPreview		enumeration	SmonParam		enumeration	PktEv		enumeration	PktTm		enumeration	PktTc		enumeration	PktTmStatistics	
Kind	Value	annotation																													
enumeration	Param																														
enumeration	ParamStatistics																														
enumeration	ParamDefinition																														
enumeration	ParamPreview																														
enumeration	SmonParam																														
enumeration	PktEv																														
enumeration	PktTm																														
enumeration	PktTc																														
enumeration	PktTmStatistics																														



enumeration	PktTcStatistics
enumeration	PktEvStatistics
enumeration	PktEvRaw
enumeration	PktTmRaw
enumeration	PktTcRaw
enumeration	PktTmReport
enumeration	PktTcReport
enumeration	PktTmGapReport
enumeration	EventRecordReport
enumeration	ArchiveCatalogue
enumeration	ArchiveFile
enumeration	ArchiveSubscription
enumeration	OolRecordReport
enumeration	EddsUsageReport
enumeration	ParamStream
enumeration	PktEvStream
enumeration	PktTmStream
enumeration	PktTcStream
enumeration	OolStream
enumeration	FileSystemFileCatalogue
enumeration	FileSystemFolderCatalogue
enumeration	FileSystemFile
enumeration	FileSystemSubscription

### ***D.21 simpleType DataCompression***

namespace	http://edds.egos.esa/model
type	restriction of <b>xs:string</b>
properties	base xs:string
used by	element <b>RequestPostProcessing/DataCompression</b>
facets	Kind Value annotation enumeration ZIP enumeration TAR enumeration TARGZ enumeration NONE
annotation	documentation Defines the possible compression algorithm which can be applied to the data responses.

### ***D.22 simpleType DataEncrypting***

namespace	http://edds.egos.esa/model
type	restriction of <b>xs:string</b>
properties	base xs:string
used by	element <b>RequestPostProcessing/DataEncrypting</b>
facets	Kind Value annotation enumeration NONE enumeration AES

annotation	documentation Defines the data encryption to be applied to the data responses. The implementation of the encryption algorithm is mission specific.
------------	---

### D.23 simpleType DataSource

namespace	http://edds.egos.esa/model		
type	restriction of <b>xs:string</b>		
properties	base xs:string		
facets	Kind	Value	annotation
	enumeration	FARC	
	enumeration	DARC	
	enumeration	PARC	
	enumeration	EDDS	
	enumeration	SMON	
annotation	documentation Defines data source associated with the request		

### D.24 simpleType DOYDateTime

namespace	http://edds.egos.esa/model		
type	restriction of <b>xs:string</b>		
properties	base xs:string		
used by	elements	<b>EddsUsageReportFilterKeyword/CompletionDOYTime Time/DOYTime  TimeRange/EndDOYTime EddsUsageReportFilterKeyword/ExecutionDOYTime  PktTcFilterKeyword/ExecutionDOYTime PktTmFilterKeyword/ExtractionDOYTime  PktTmStreamFilterKeyword/ExtractionDOYTime PktEvFilterKeyword/GenerationDOYTime  PktTmFilterKeyword/GenerationDOYTime ParamFilterKeyword/OnBoardDOYTime  PktTcFilterKeyword/ReleaseDOYTime TimeRange/StartDOYTime  EddsUsageReportFilterKeyword/SubmissionDOYTime</b>	
facets	Kind	Value	annotation
	pattern	\d{4}-(00[1-9] 0[1-9] d [12]d 3 [0-5]d 6[0-6])T([01]d 2[0-3]):[0-5]d:[0-5]d(\.\d{1,6})?(Z)?	
annotation	documentation Defines the YYYY-DDD'T'HH:MM:SS[.SSSSSSZ] format with rules for days: 001-366, hours:00-23, minutes: 00-59, seconds: 00-59, optional fraction of seconds .0-.999999 and optional Zulu time indicator		

### D.25 simpleType NamePrefixSuffixElement

namespace	http://edds.egos.esa/model		
type	restriction of <b>xs:string</b>		
properties	base xs:string		
facets	Kind	Value	annotation
	enumeration	default	
	enumeration	filename	
	enumeration	prefix	
	enumeration	suffix	
annotation	documentation Defines the possible ways to use the file text.		

**D.26 simpleType OolParameterState**

namespace	http://edds.egos.esa/model		
type	restriction of <b>xs:string</b>		
properties	base xs:string		
facets	Kind	Value	annotation
	enumeration	NOMINAL	
	enumeration	WARNING	
	enumeration	OUT_OF_LIMITS	
	enumeration	SCC	
	enumeration	SCC_DISABLE	
	enumeration	SCC_OFF	
	enumeration	SCC_UNINIT	
	enumeration	VIOLATION	
	enumeration	NO_VALUE	documentation NO_VALUE is used if a value is returned from the archive that doesn't match a value from this enumerated list

**D.27 simpleType OolRecordType**

namespace	http://edds.egos.esa/model		
type	restriction of <b>xs:string</b>		
properties	base xs:string		
facets	Kind	Value	annotation
	enumeration	LIMIT	
	enumeration	STATE	
	enumeration	STATUS_CONSISTENCY	
	enumeration	SOFT_HARD_LIMIT	
	enumeration	LIMIT_MO	
	enumeration	DELTA	
	enumeration	NO_VALUE	documentation NO_VALUE is used if a value is returned from the archive that doesn't match a value from this enumerated list

**D.28 simpleType OolState**

namespace	http://edds.egos.esa/model		
type	restriction of <b>xs:string</b>		
properties	base xs:string		
facets	Kind	Value	annotation
	enumeration	INCONSISTENT_STATUS	
	enumeration	NOMINAL	
	enumeration	OUT_OF_LIMIT	
	enumeration	UNCHECKED	
	enumeration	UNDEFINED	
	enumeration	VIOLATED	
	enumeration	WARNING	

**D.29 simpleType Operation**

namespace	http://edds.egos.esa/model		
type	restriction of <b>xs:string</b>		
properties	base xs:string		
facets	Kind	Value	annotation
	enumeration	OP_EQ	
	enumeration	OP_NEQ	
	enumeration	OP_GT	
	enumeration	OP_GTE	
	enumeration	OP_LT	
	enumeration	OP_LTE	
	enumeration	OP_NOT	
	enumeration	OP_MATCH	
	enumeration	OP_CONTAINS	documentation Used for container objects; matches lists containing the specified filter item, but the container is allowed to contain other items not specified.

**D.30 simpleType OrderBy**

namespace	http://edds.egos.esa/model		
type	restriction of <b>xs:string</b>		
properties	base xs:string		
facets	Kind	Value	annotation
	enumeration	creation_time ASC	
	enumeration	creation_time DESC	
	enumeration	scheduled_execution_time ASC	
	enumeration	scheduled_execution_time DESC	
	enumeration	username ASC	
	enumeration	username DESC	
annotation	documentation Defines the possible compression algorithm which can be applied to the data responses.		

**D.31 simpleType ParamValidityStatus**

namespace	http://edds.egos.esa/model		
type	restriction of <b>xs:string</b>		
properties	base xs:string		
facets	Kind	Value	annotation
	enumeration	VALID	
	enumeration	INVALID	
	enumeration	UNKNOWN	
	enumeration	EXPIRED	
annotation	documentation The possible validity states of a parameter		

**D.32 simpleType PrivacyTag**

namespace	http://edds.egos.esa/model		
type	restriction of <b>xs:string</b>		
properties	base <b>xs:string</b>		
used by	element	<b>ContextPart/PrivacyTag</b>	
facets	Kind	Value	annotation
	enumeration	PRIVATE	
	enumeration	ROLE	
	enumeration	MISSION	
	enumeration	PUBLIC	
annotation	documentation Defines privacy tag values which can be associated to a request		

**D.33 simpleType SpidsSpecifier**

namespace	http://edds.egos.esa/model		
type	restriction of <b>xs:string</b>		
properties	base <b>xs:string</b>		
used by	elements	<b>PacketName/Apid PacketName/Pi1 PacketName/Pi2 PacketName/Spid PacketName/SubType PacketName/Type</b>	
facets	Kind	Value	annotation
	pattern	(\s*((\d+\s*\d+) [\^,\s]+))\s*(\s*((\d+\s*\d+) [\^,\s]+))\s*)\s*	
annotation	documentation A string with regex restriction to allow for a comma separated list of both string values and numeric value ranges.		

**D.34 simpleType State**

namespace	http://edds.egos.esa/model		
type	restriction of <b>xs:string</b>		
properties	base <b>xs:string</b>		
facets	Kind	Value	annotation
	enumeration	SUBMITTED	documentation The request reached the web server and has been saved into the DB
	enumeration	CANCELED	documentation The request has been cancelled
	enumeration	SUSPENDED	documentation The request has been suspended
	enumeration	QUEUED	documentation A submitted request is taken from the DB and queued for execution in the edds-server
	enumeration	COMPLETED_NO_RESULTS	documentation The edds-server completed the elaboration of a request and no results were received from the archive
	enumeration	SERVER_COMPLETED	documentation The edds-server completed the elaboration of a request and dispatch the result to the delivery-manager
	enumeration	DELIVERED	documentation The request execution is completed
	enumeration	DELIVERED_RESP_DELETED	documentation The request execution is completed and the data on EDDS file server is deleted
	enumeration	DELIVERED_PARTIAL_RESULTS	documentation The request execution is completed, but not all of the requested data could be retrieved
	enumeration	ERROR_LOCALLY_DELIVERED	documentation The request execution is completed, but the delivery manager was not able to dispatch the result through

	<p>enumeration ERROR_ACCESS_DENIED</p> <p>enumeration ERROR_INVALID_REQUEST</p> <p>enumeration ERROR_LIMIT_EXCEEDED</p> <p>enumeration ERROR_SERVER_NOT_AVAILABLE</p> <p>enumeration ERROR_DELIVERY</p> <p>enumeration ERROR_UNKNOWN</p>	<p>FTP. The file is available in the EDDS Server FTP directory</p> <p>documentation The user does not have the right privileges to execute the request</p> <p>documentation The request is not valid</p> <p>documentation The quota associated with the user has been exceeded</p> <p>documentation The needed data provider is not available</p> <p>documentation The delivery manager was not able to deliver the file</p> <p>documentation Not predictable error in the request processing</p>
annotation	documentation Request execution statuses	

## Appendix E Delivery Data Type

This section of the document describes the complex types used for delivery as defined in the delivery.xsd file.

### E.1 complexType AckDelivery

diagram	 <p>The diagram shows the AckDelivery complex type structure. It consists of an AckDelivery element (represented by a rounded rectangle with a small square on the right) connected to a choice element (represented by a circle with a vertical line and a small square on the right). This choice element contains two child elements: EmailDelivery (represented by a rounded rectangle with a small square on the right) and another element (represented by a rounded rectangle with a small square on the right).</p> <p>Defines the mechanism used to deliver the acknowledgement message to the user.</p> <p>Defines the E-mail Delivery</p>
namespace	http://edds.egos.esa/model
children	<b>EmailDelivery</b>
annotation	documentation Defines the mechanism used to deliver the acknowledgement message to the user.

### E.2 complexType Delivery

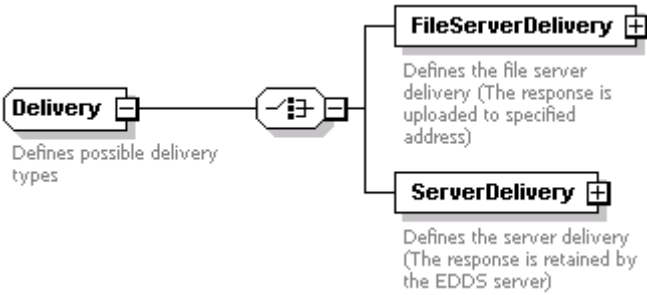
diagram	 <p>The diagram shows the Delivery complex type structure. It consists of a Delivery element (represented by a rounded rectangle with a small square on the right) connected to a choice element (represented by a circle with a vertical line and a small square on the right). This choice element contains two child elements: FileServerDelivery (represented by a rounded rectangle with a small square on the right) and ServerDelivery (represented by a rounded rectangle with a small square on the right).</p> <p>Defines possible delivery types</p> <p>Defines the file server delivery (The response is uploaded to specified address)</p> <p>Defines the server delivery (The response is retained by the EDDS server)</p>
namespace	http://edds.egos.esa/model
children	<b>FileServerDelivery ServerDelivery</b>
annotation	documentation Defines possible delivery types

### E.3 complexType EmailDelivery

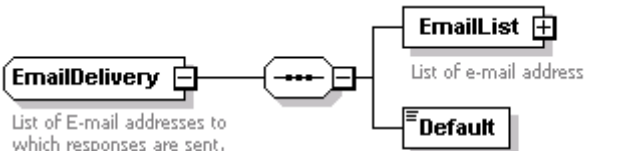
diagram	 <p>The diagram shows the EmailDelivery complex type structure. It consists of an EmailDelivery element (represented by a rounded rectangle with a small square on the right) connected to a choice element (represented by a circle with a vertical line and a small square on the right). This choice element contains two child elements: EmailList (represented by a rounded rectangle with a small square on the right) and Default (represented by a rounded rectangle with a small square on the right).</p> <p>List of E-mail addresses to which responses are sent.</p> <p>List of e-mail address</p> <p>If true the default e-mail address associated with the user is also used.</p>
namespace	http://edds.egos.esa/model
children	<b>EmailList Default</b>
used by	element <b>AckDelivery/EmailDelivery</b>
annotation	documentation List of E-mail addresses to which responses are sent.

### E.4 complexType FileServerDelivery

<p>diagram</p>	<p><b>TargetLocations</b> 1..∞</p> <p><b>FileName</b> The text that will be used as the file name, or added as a suffix/prefix</p> <p><b>NamePrefixSuffix</b> Selection to use the FileText as Filename, Prefix or Suffix</p> <p><b>KeepFileAfterDelivery</b> Defines if the data responses has to be deleted after a successful delivery. By default the file is deleted from the EDDS server.</p> <p><b>TimeFormat</b> The time format to use in the filename</p> <p><b>CustomTimeFormat</b> The custom time format to use in the filename</p>
<p>namespace</p>	<p>http://edds.egos.esa/model</p>
<p>children</p>	<p><b>TargetLocations</b> <b>FileName</b> <b>NamePrefixSuffix</b> <b>KeepFileAfterDelivery</b> <b>TimeFormat</b> <b>CustomTimeFormat</b></p>
<p>used by</p>	<p>element <b>Delivery/FileServerDelivery</b></p>



### E.5 complexType ServerDelivery

<p>diagram</p>	<p><b>FileName</b> The text that will be used as the file name, or added as a suffix/prefix</p> <p><b>NamePrefixSuffix</b> Selection to use the FileText as Filename, Prefix or Suffix</p> <p><b>TimeFormat</b> The time format to use in the filename</p> <p><b>CustomTimeFormat</b> The custom time format to use in the filename</p>
<p>namespace</p>	<p>http://edds.egos.esa/model</p>
<p>children</p>	<p><b>FileName NamePrefixSuffix TimeFormat CustomTimeFormat</b></p>
<p>used by</p>	<p>element <b>Delivery/ServerDelivery</b></p>

### E.6 complexType TargetLocation

<p>diagram</p>	<p><b>Target</b> Address to which the file have to be delivered</p> <p><b>FileServerUsername</b> The optional remote account to be used, in case the delivery has to be done in SFTP (and not FTP)</p> <p><b>FileServerPassword</b> The optional password for the remote user, in case the delivery has to be done in SFTP (and not FTP)</p> <p><b>TargetFolder</b> Folder to which the file has to be delivered</p> <p>Defines the information about the remote FTP server for connecting and sending the required files</p>
<p>namespace</p>	<p>http://edds.egos.esa/model</p>
<p>children</p>	<p><b>Target FileServerUsername FileServerPassword TargetFolder</b></p>

used by	element <b>FileServerDelivery/TargetLocations</b>
annotation	documentation Defines the information about the remote FTP server for connecting and sending the required files

## Appendix F File System Data Types

### F.1 complexType FileFilterEntry

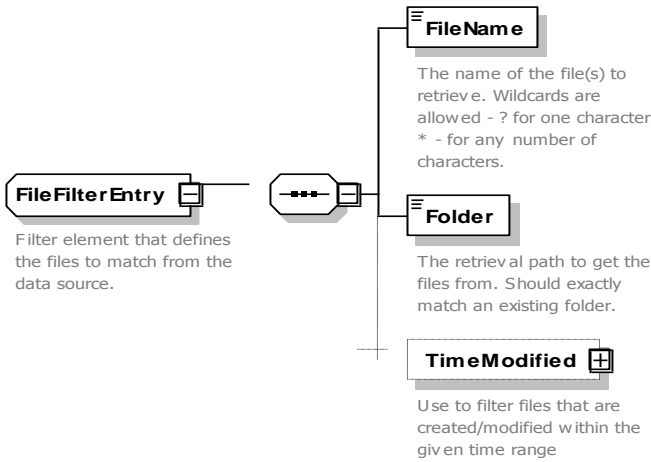
<p>diagram</p>	 <p><b>FileFilterEntry</b> Filter element that defines the files to match from the data source.</p> <p><b>FileName</b> The name of the file(s) to retrieve. Wildcards are allowed - ? for one character, * - for any number of characters.</p> <p><b>Folder</b> The retrieval path to get the files from. Should exactly match an existing folder.</p> <p><b>TimeModified</b> Use to filter files that are created/modified within the given time range.</p>
<p>namespace</p>	<p>http://edds.egos.esa/model</p>
<p>children</p>	<p><b>FileName Folder TimeModified</b></p>
<p>used by</p>	<p>element <b>FileSystemFile/FileFilterEntry</b></p>
<p>annotation</p>	<p>documentation Filter element that defines the files to match from the data source.</p>

### F.2 complexType FileSystemCatalogue

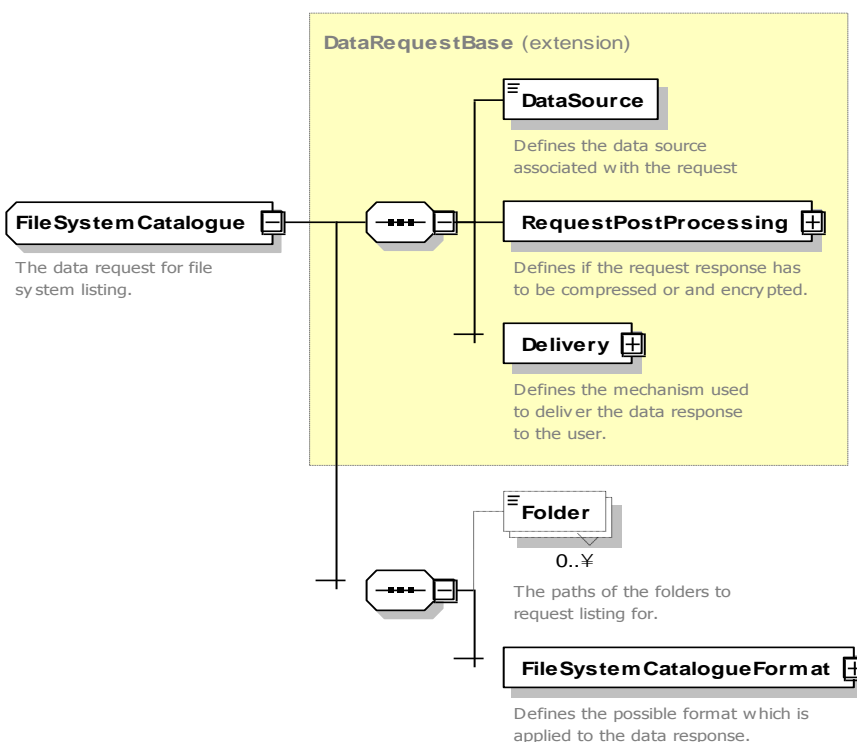
<p>diagram</p>	 <p><b>FileSystemCatalogue</b> The data request for file system listing.</p> <p><b>DataRequestBase (extension)</b></p> <p><b>DataSource</b> Defines the data source associated with the request.</p> <p><b>RequestPostProcessing</b> Defines if the request response has to be compressed or and encrypted.</p> <p><b>Delivery</b> Defines the mechanism used to deliver the data response to the user.</p> <p><b>Folder</b> 0..∞ The paths of the folders to request listing for.</p> <p><b>FileSystemCatalogueFormat</b> Defines the possible format which is applied to the data response.</p>
----------------	---

namespace	http://edds.egos.esa/model
type	extension of <b>DataRequestBase</b>
properties	base DataRequestBase abstract true
children	<b>DataSource RequestPostProcessing Delivery Folder FileSystemCatalogueFormat</b>
used by	complexType <a href="#">FileSystemFileCatalogue</a> <a href="#">FileSystemFolderCatalogue</a>
annotation	documentation The data request for file system listing.

### F.3 complexType *FileSystemCatalogueFormat*

diagram	<p>The possible formatting options for file system catalogue response</p>
namespace	http://edds.egos.esa/model
children	<b>XML ASCII</b>
used by	element <b>FileSystemCatalogue/FileSystemCatalogueFormat</b>
annotation	documentation The possible formatting options for file system catalogue response

### F.4 complexType *FileSystemFile*

diagram	<p>The data request of the files from the file system data source.</p> <p><b>DataRequestBase (extension)</b></p> <ul style="list-style-type: none"> <li><b>DataSource</b>: Defines the data source associated with the request</li> <li><b>RequestPostProcessing</b>: Defines if the request response has to be compressed or and encrypted.</li> <li><b>Delivery</b>: Defines the mechanism used to deliver the data response to the user.</li> </ul> <p><b>FileFilterEntry</b> 1..*</p> <p>The filter entries are combined as logical OR.</p>
namespace	http://edds.egos.esa/model
type	extension of <b>DataRequestBase</b>
properties	base DataRequestBase
children	<b>DataSource RequestPostProcessing Delivery FileFilterEntry</b>
annotation	documentation The data request of the files from the file system data source.

### F.5 complexType FileSystemFileCatalogue

<p>diagram</p>	
<p>namespace</p>	<p>http://edds.egos.esa/model</p>
<p>type</p>	<p>extension of <a href="#">FileSystemCatalogue</a></p>
<p>properties</p>	<p>base FileSystemCatalogue</p>
<p>children</p>	<p><b>DataSource RequestPostProcessing Delivery Folder FileSystemCatalogueFormat</b></p>
<p>annotation</p>	<p>documentation The data request for file system listing of files in requested catalogues.</p>

### F.6 complexType FileSystemFileCatalogueElement

<p>diagram</p>	
<p>namespace</p>	<p>http://edds.egos.esa/model</p>
<p>children</p>	<p><b>Folder FileName Modified</b></p>
<p>used by</p>	<p>elements <b>FileSystemFileCatalogueElement</b> <b>FileSystemFileCatalogueResponse/FileSystemFileCatalogueElement</b></p>

annotation	documentation Describes the single catalogue entry
------------	---

### F.7 complexType FileSystemFileCatalogueResponse

diagram	
namespace	http://edds.egos.esa/model
children	FileSystemFileCatalogueElement
annotation	documentation Defines the response list of catalogue entries

### F.8 complexType FileSystemFolderCatalogue

diagram	
namespace	http://edds.egos.esa/model
type	extension of <a href="#">FileSystemCatalogue</a>
properties	base FileSystemCatalogue
children	DataSource RequestPostProcessing Delivery Folder FileSystemCatalogueFormat
annotation	documentation The data request for file system structure recursively listing all subfolders

### F.9 complexType *FileSystemFolderCatalogueElement*

diagram	<p>Defines the single structure response entry</p> <p>Defines the name of the catalogue</p>
namespace	http://edds.egos.esa/model
children	<b>Folder</b>
used by	elements <b>FileSystemFolderCatalogueElement</b> <b>FileSystemFolderCatalogueResponse/FileSystemFolderCatalogueElement</b>
annotation	documentation Describes the single structure response entry

### F.10 complexType *FileSystemFolderCatalogueResponse*

diagram	<p>Defines the response list of structure entries</p> <p>0..∞</p>
namespace	http://edds.egos.esa/model
children	<b>FileSystemFolderCatalogueElement</b>
annotation	documentation Defines the response list of structure entries

### F.11 complexType FileSystemSubscription

<p>diagram</p>	<pre> classDiagram     class FileSystemSubscription {         Filter element that defines the files to match from the data source.     }     class DataRequestBase {         DataSource         RequestPostProcessing         Delivery     }     class FileName {         The name of the file(s) to retrieve. Wildcards are allowed - ? for one character, * - for any number of characters.     }     class Folder {         The retrieval path to monitor the files from. Should exactly match an existing folder.     }     class RetrieveFile {         If true, the file(s) will be automatically retrieved when the notification is received     }     class SendEmail {         If true, an e-mail will be sent when the notification is received     }      FileSystemSubscription -- &gt; DataRequestBase     FileSystemSubscription -- FileName     FileSystemSubscription -- Folder     FileSystemSubscription -- RetrieveFile     FileSystemSubscription -- SendEmail     </pre>
<p>namespace</p>	<p>http://edds.egos.esa/model</p>
<p>type</p>	<p>extension of <b>DataRequestBase</b></p>
<p>properties</p>	<p>base DataRequestBase</p>
<p>children</p>	<p><b>DataSource RequestPostProcessing Delivery FileName Folder RetrieveFile SendEmail</b></p>
<p>annotation</p>	<p>documentation Filter element that defines the files to match from the data source.</p>

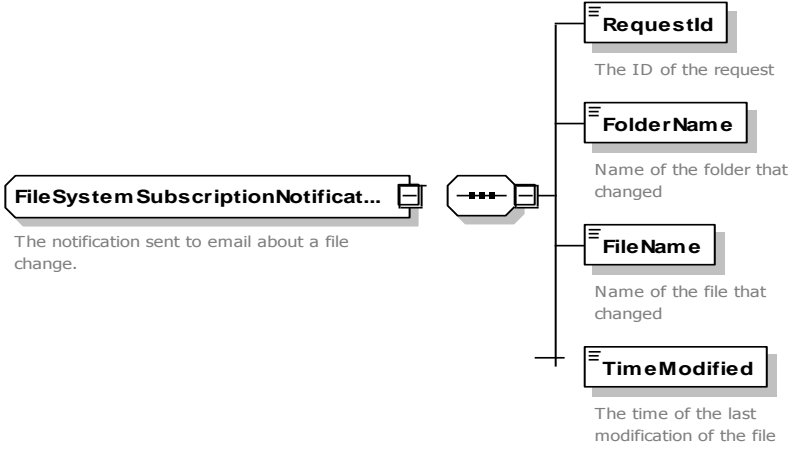

**F.12 complexType FileSystemSubscriptionNotification**

<p>diagram</p>	
<p>namespace</p>	<p><a href="http://edds.egos.esa/model">http://edds.egos.esa/model</a></p>
<p>children</p>	<p><b>RequestId FolderName FileName TimeModified</b></p>
<p>used by</p>	<p>element <b>FileSystemSubscriptionNotification</b></p>
<p>annotation</p>	<p>documentation The notification sent to email about a file change.</p>

## Appendix G Filter Data Type

This section of the document describes the filter complex types as defined in the filter.xsd file.

### G.1 complexType ArchiveFileFilter

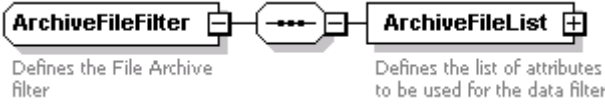
diagram	 <p>Defines the File Archive filter</p> <p>Defines the list of attributes to be used for the data filter</p>
namespace	http://edds.egos.esa/model
children	<b>ArchiveFileList</b>
annotation	documentation Defines the File Archive filter

### G.2 complexType ArchiveFileList

diagram	 <p>A list of archive files</p> <p>0..∞</p> <p>Defines the file filter element</p>
namespace	http://edds.egos.esa/model
children	<b>ArchiveFileListElement</b>
used by	element <b>ArchiveFileFilter/ArchiveFileList</b>
annotation	documentation A list of archive files

### G.3 complexType ArchiveFileListElement

<p>diagram</p>	<p><b>ArchiveFileListElement</b> Defines the sequence of attributes which define a file filter</p> <ul style="list-style-type: none"> <li><b>Name</b>: File Name</li> <li><b>Folder</b>: File Folder</li> <li><b>Type</b>: List of file type</li> <li><b>Version</b>: File Version</li> <li><b>Description</b>: File description</li> <li><b>Comment</b>: File comment</li> <li><b>CreationTime</b>: Creation Time choice</li> <li><b>ValidityTime</b>: Validity Time choice</li> </ul>
<p>namespace</p>	<p>http://edds.egos.esa/model</p>
<p>children</p>	<p><b>Name Folder Type Version Description Comment CreationTime ValidityTime</b></p>
<p>used by</p>	<p>element <b>ArchiveFileList/ArchiveFileListElement</b></p>
<p>annotation</p>	<p>documentation Defines the sequence of attributes which define a file filter</p>

### G.4 complexType CatalogueFilter

<p>diagram</p>	<p><b>CatalogueFilter</b> Defines the Archive Catalogue filter</p> <p><b>CatalogueFilterList</b> Defines the list of attributes to be used for the data filter</p>
<p>namespace</p>	<p>http://edds.egos.esa/model</p>
<p>children</p>	<p><b>CatalogueFilterList</b></p>
<p>annotation</p>	<p>documentation Defines the Archive Catalogue filter</p>

### G.5 complexType CatalogueFilterList

<p>diagram</p>	<p><b>CatalogueFilterList</b> Defines a list of Catalogue filter</p> <p><b>CatalogueFilterListElement</b> Defines the catalogue filter element</p>
<p>namespace</p>	<p>http://edds.egos.esa/model</p>
<p>children</p>	<p><b>CatalogueFilterListElement</b></p>
<p>used by</p>	<p>element <b>CatalogueFilter/CatalogueFilterList</b></p>
<p>annotation</p>	<p>documentation Defines a list of Catalogue filter</p>

### G.6 complexType CatalogueFilterListElement

<p>diagram</p>	
<p>namespace</p>	<p>http://edds.egos.esa/model</p>
<p>children</p>	<p><b>Name Folder Type Version Description Comment CreationTime ValidityTime</b></p>
<p>used by</p>	<p>element <b>CatalogueFilterList/CatalogueFilterListElement</b></p>
<p>annotation</p>	<p>documentation Defines the sequence of attributes which define a catalogue filter filter</p>

### G.7 complexType EddsUsageReportFilter

<p>diagram</p>	
----------------	--

namespace	http://edds.egos.esa/model
children	<b>TimeRange EddsUsageReportFilterElement State AllUsersData OrderBy</b>
annotation	documentation Defines the sequence of attributes which define an Edds usage Report filter

### G.8 complexType EddsUsageReportFilterElement

diagram	
namespace	http://edds.egos.esa/model
children	<b>EddsUsageReportFilterKeyword Operation</b>
used by	element <b>EddsUsageReportFilter/EddsUsageReportFilterElement</b>

### G.9 complexType EddsUsageReportFilterKeyword

diagram	
namespace	http://edds.egos.esa/model
children	<b>Role SubmissionTime SubmissionDOYTime ExecutionTime ExecutionDOYTime CompletionTime CompletionDOYTime ResponseDataSize ReasonOfFailure</b>
used by	element <b>EddsUsageReportFilterElement/EddsUsageReportFilterKeyword</b>

### G.10 complexType EvFilterElement

diagram	
---------	--

namespace	http://edds.egos.esa/model
children	<b>PktEvFilterKeyword</b> <b>Operation</b>
used by	element <b>EvFilterList</b> / <b>EvFilterListElement</b>

### G.11 complexType EvFilterList

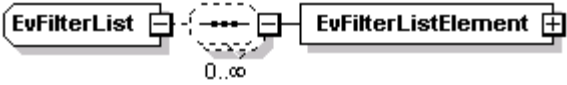
diagram	
namespace	http://edds.egos.esa/model
children	<b>EvFilterListElement</b>
used by	element <b>EvPacketFilter</b> / <b>EvFilterList</b>

### G.12 complexType EvPacketFilter

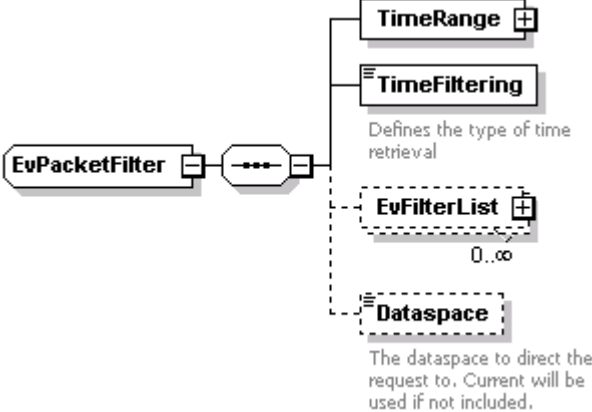
diagram	
namespace	http://edds.egos.esa/model
children	<b>TimeRange</b> <b>TimeFiltering</b> <b>EvFilterList</b> <b>Dataspace</b>

TimeFiltering: Defines the type of time retrieval

Dataspace: The dataspace to direct the request to. Current will be used if not included.

### G.13 complexType EvStreamFilterList

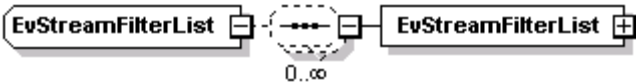
diagram	
namespace	http://edds.egos.esa/model
children	<b>EvStreamFilterList</b>

### G.14 complexType EvStreamFilterListElement

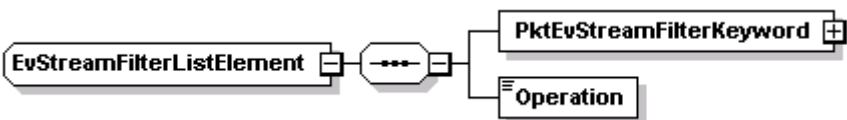
diagram	
---------	--

namespace	http://edds.egos.esa/model
children	<b>PktEvStreamFilterKeyword Operation</b>
used by	element <b>EvStreamFilterList/EvStreamFilterList</b>

**G.15 complexType OolDataReportFilter**

diagram	
namespace	http://edds.egos.esa/model
children	<b>TimeRange TimeFiltering OolFilterList Dataspace</b>
annotation	documentation Defines the OOL data report filter

**G.16 complexType OolFilterElement**

diagram	
namespace	http://edds.egos.esa/model
children	<b>OolFilterKeyword Operation</b>
used by	element <b>OolFilterList/OolFilterListElement</b>

### G.17 complexType OolFilterKeyword

<p>diagram</p>	<p><b>RecordType</b> One of LIMIT, STATE, STATUS_CONSISTENCY, SOFT_HARD_LIMIT, LIMIT_MO, DELTA</p> <p><b>ParameterName</b></p> <p><b>ParameterState</b> One of NOMINAL, WARNING, OUT_OF_LIMITS, SCC, SCC_DISABLE, SCC_OFF, SCC_LINIT, VIOLATION</p> <p><b>OolState</b></p> <p><b>Value</b></p> <p><b>LowerLimit</b> Only for LIMIT, SOFT_HARD_LIMIT, LIMIT_MO types</p> <p><b>UpperLimit</b> Only for LIMIT, SOFT_HARD_LIMIT, LIMIT_MO types</p> <p><b>AllowedValues</b> Each value should be comma separated</p> <p><b>SccLimit</b> Only for STATUS_CONSISTENCY types</p> <p><b>ReferenceValue</b> Only for DELTA types</p> <p><b>DeltaValue</b> Only for DELTA types</p> <p><b>MinValue</b> Only for DELTA types</p> <p><b>LastValue</b> Only for DELTA types</p> <p><b>ViolationNumber</b> Not for DELTA types</p> <p><b>ViolationNumberHard</b> Only for SOFT_HARD_LIMIT types</p> <p><b>ViolationNumberSoft</b> Only for SOFT_HARD_LIMIT types</p> <p><b>Description</b></p> <p><b>Unit</b></p> <p><b>MaximumDataVolume</b></p>
<p>namespace</p>	<p><a href="http://eds.egos.esa/model">http://eds.egos.esa/model</a></p>
<p>children</p>	<p><b>RecordType</b> <b>ParameterName</b> <b>ParameterState</b> <b>OolState</b> <b>Value</b> <b>LowerLimit</b> <b>UpperLimit</b> <b>AllowedValues</b> <b>SccLimit</b> <b>ReferenceValue</b> <b>DeltaValue</b> <b>MinValue</b> <b>LastValue</b> <b>ViolationNumber</b> <b>ViolationNumberHard</b> <b>ViolationNumberSoft</b> <b>Description</b> <b>Unit</b> <b>MaximumDataVolume</b></p>



	<b>Description Unit MaximumDataVolume</b>
used by	element <b>OolFilterElement/OolFilterKeyword</b>

### ***G.18 complexType OolFilterList***

diagram	<pre> classDiagram     class OolFilterList     class OolFilterListElement     OolFilterList "0..∞" -- OolFilterListElement   </pre>
namespace	http://edds.egos.esa/model
children	<b>OolFilterListElement</b>
used by	element <b>OolDataReportFilter/OolFilterList</b>

### G.19 complexType OolStreamFilterKeyword

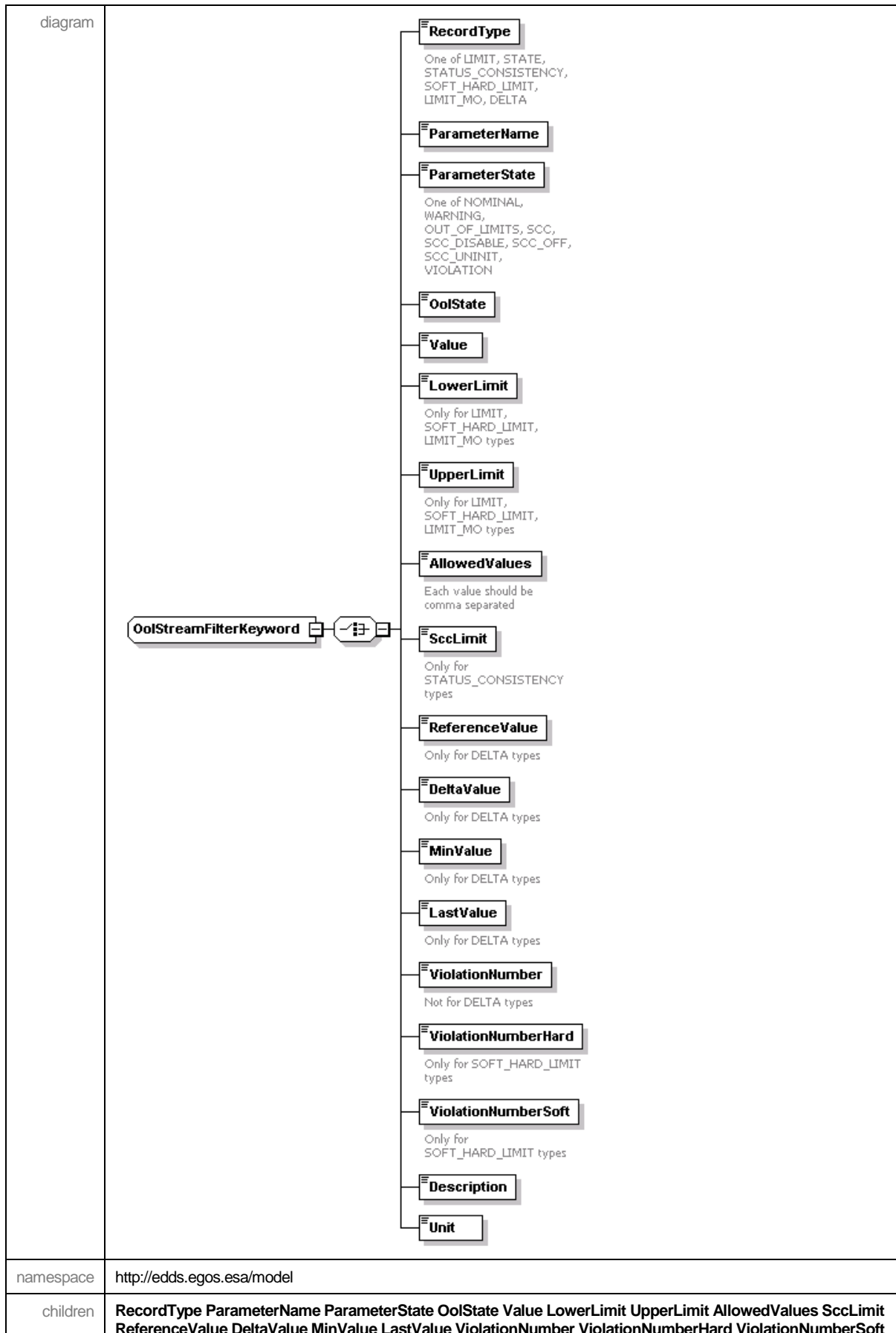

	<b>Description Unit</b>
used by	element <b>OolStreamFilterListElement/OolStreamFilterKeyword</b>

**G.20 complexType OolStreamFilterList**

diagram	
namespace	http://edds.egos.esa/model
children	<b>OolStreamFilterList</b>

**G.21 complexType OolStreamFilterListElement**

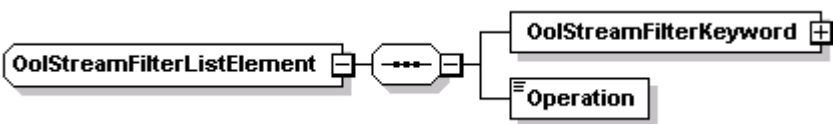
diagram	
namespace	http://edds.egos.esa/model
children	<b>OolStreamFilterKeyword Operation</b>
used by	element <b>OolStreamFilterList/OolStreamFilterList</b>

**G.22 complexType ParamFilterKeyword**

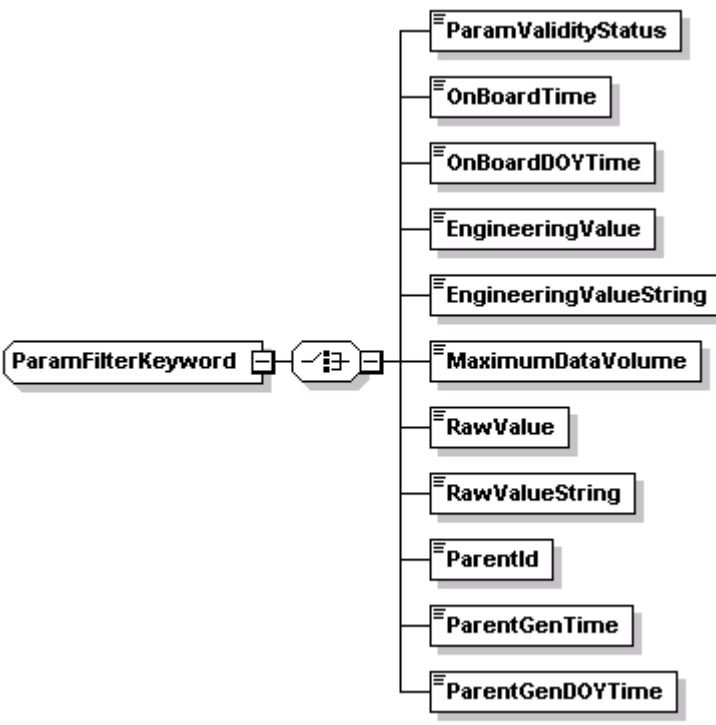
diagram	
namespace	http://edds.egos.esa/model
children	<b>ParamValidityStatus OnBoardTime OnBoardDOYTime EngineeringValue EngineeringValueString MaximumDataVolume RawValue RawValueString ParentId ParentGenTime ParentGenDOYTime</b>
used by	element <b>ParamFilterListElement/ParamFilterKeyword</b>

### G.23 complexType ParamFilterList

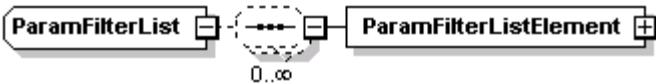
diagram	
namespace	http://edds.egos.esa/model
children	ParamFilterListElement
used by	element ParamTmFilter/ParamFilterList

### G.24 complexType ParamFilterListElement

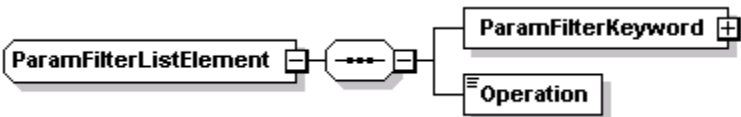
diagram	
namespace	http://edds.egos.esa/model
children	ParamFilterKeyword Operation
used by	element ParamFilterList/ParamFilterListElement

### G.25 complexType ParamPreviewFilter

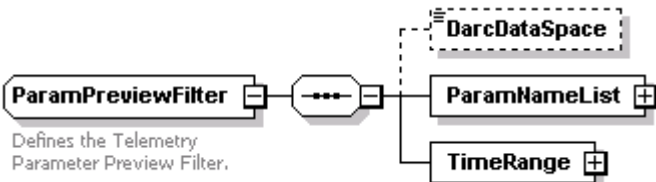
diagram	 Defines the Telemetry Parameter Preview Filter.
namespace	<a href="http://edds.egos.esa/model">http://edds.egos.esa/model</a>
children	DarcDataSpace ParamNameList TimeRange
annotation	documentation Defines the Telemetry Parameter Preview Filter.

### G.26 complexType ParamStatisticsFilter

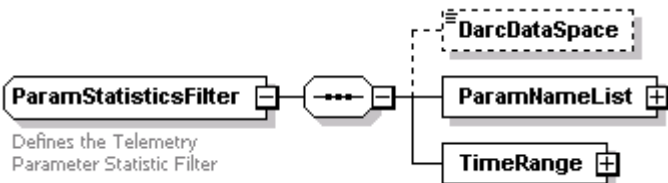
diagram	 Defines the Telemetry Parameter Statistic Filter.
namespace	http://edds.egos.esa/model

children	DarcDataSpace ParamNameList TimeRange
annotation	documentation Defines the Telemetry Parameter Statistic Filter

**G.27 complexType ParamStreamFilterKeyword**

diagram	
namespace	http://edds.egos.esa/model
children	ParamValidityStatus StringValue DoubleValue FloatValue IntegerValue LongValue BooleanValue
used by	element ParamStreamFilterListElement/ParamStreamFilterKeyword

**G.28 complexType ParamStreamFilterList**

diagram	
namespace	http://edds.egos.esa/model
children	ParamStreamFilterListElement

**G.29 complexType ParamStreamFilterListElement**

diagram	
namespace	http://edds.egos.esa/model
children	ParamStreamFilterKeyword Operation
used by	element ParamStreamFilterList/ParamStreamFilterListElement

### G.30 complexType ParamTmFilter

<p>diagram</p>	<p><b>ParamTmFilter</b> Defines the Telemetry Parameter Filter</p> <ul style="list-style-type: none"> <li><b>DarcDataSpace</b></li> <li><b>ParamNameList</b></li> <li><b>TimeRange</b></li> <li><b>TimeFiltering</b> Defines the type of time retrieval. If omitted, the default of GENERATION_TIME is used. Note that if STORAGE_TIME is specified, this is the storage time of the parameter sample in the DARC.</li> <li><b>DeliveryRange</b></li> <li><b>OnChange</b></li> <li><b>ParamFilterList</b> 0..∞</li> <li><b>SuperCommutationFlag</b> Not supported by DARC</li> <li><b>MaxDecimalPlaces</b> The maximum number of decimal places for float-type data for the TDRS format. Default is 3.</li> <li><b>TdrsUseDOY</b> If true, the TDRS format will use the DOY format for dates, otherwise it will use DMY.</li> <li><b>TdrsStatsOnly</b> If true, only the statistics will be included the TDRS report output</li> <li><b>TdrsDataOnly</b> If true, only the data will be included the TDRS report output</li> <li><b>RepresentationSelection</b></li> </ul>
<p>namespace</p>	<p><a href="http://edds.egos.esa/model">http://edds.egos.esa/model</a></p>
<p>children</p>	<p><b>DarcDataSpace ParamNameList TimeRange TimeFiltering DeliveryRange OnChange ParamFilterList SuperCommutationFlag MaxDecimalPlaces TdrsUseDOY TdrsStatsOnly TdrsDataOnly RepresentationSelection</b></p>
<p>annotation</p>	<p>documentation Defines the Telemetry Parameter Filter</p>

### G.31 complexType PktEvFilterKeyword

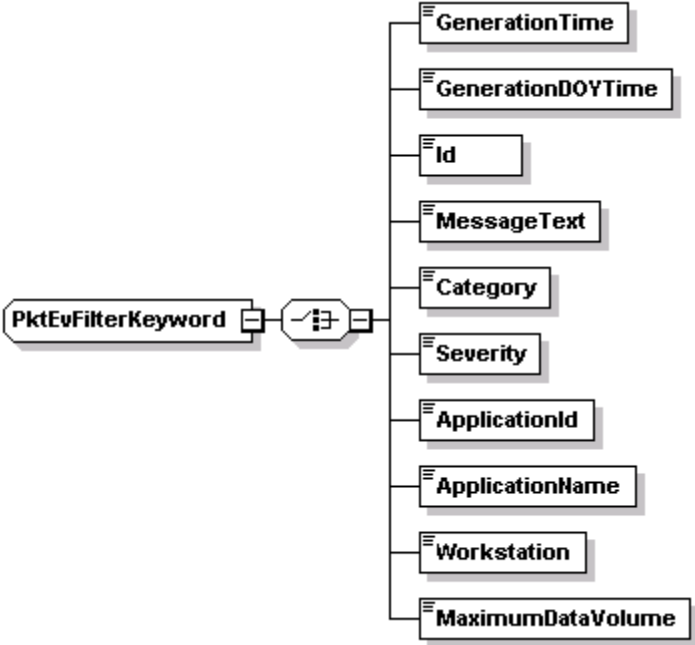
<p>diagram</p>	
<p>namespace</p>	<p><a href="http://edds.egos.esa/model">http://edds.egos.esa/model</a></p>
<p>children</p>	<p><a href="#">GenerationTime</a> <a href="#">GenerationDOYTime</a> <a href="#">Id</a> <a href="#">MessageText</a> <a href="#">Category</a> <a href="#">Severity</a> <a href="#">ApplicationId</a> <a href="#">ApplicationName</a> <a href="#">Workstation</a> <a href="#">MaximumDataVolume</a></p>
<p>used by</p>	<p>element <b>EvFilterElement/PktEvFilterKeyword</b></p>

### G.32 complexType PktEvStreamFilterKeyword

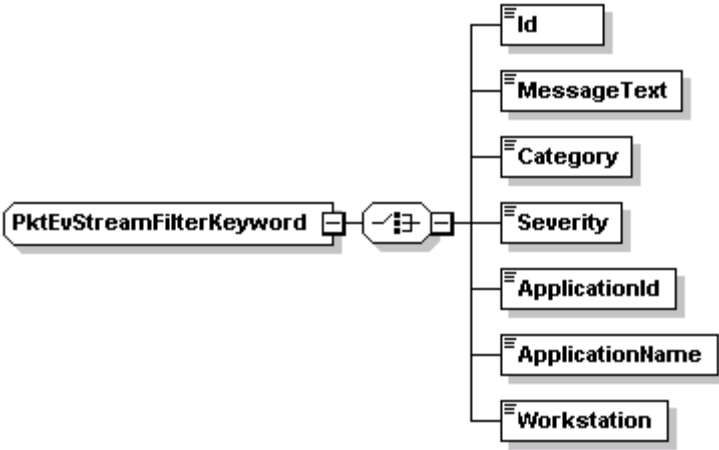
<p>diagram</p>	
<p>namespace</p>	<p><a href="http://edds.egos.esa/model">http://edds.egos.esa/model</a></p>
<p>children</p>	<p><a href="#">Id</a> <a href="#">MessageText</a> <a href="#">Category</a> <a href="#">Severity</a> <a href="#">ApplicationId</a> <a href="#">ApplicationName</a> <a href="#">Workstation</a></p>
<p>used by</p>	<p>element <b>EvStreamFilterListElement/PktEvStreamFilterKeyword</b></p>

### G.33 complexType PktTcFilterKeyword

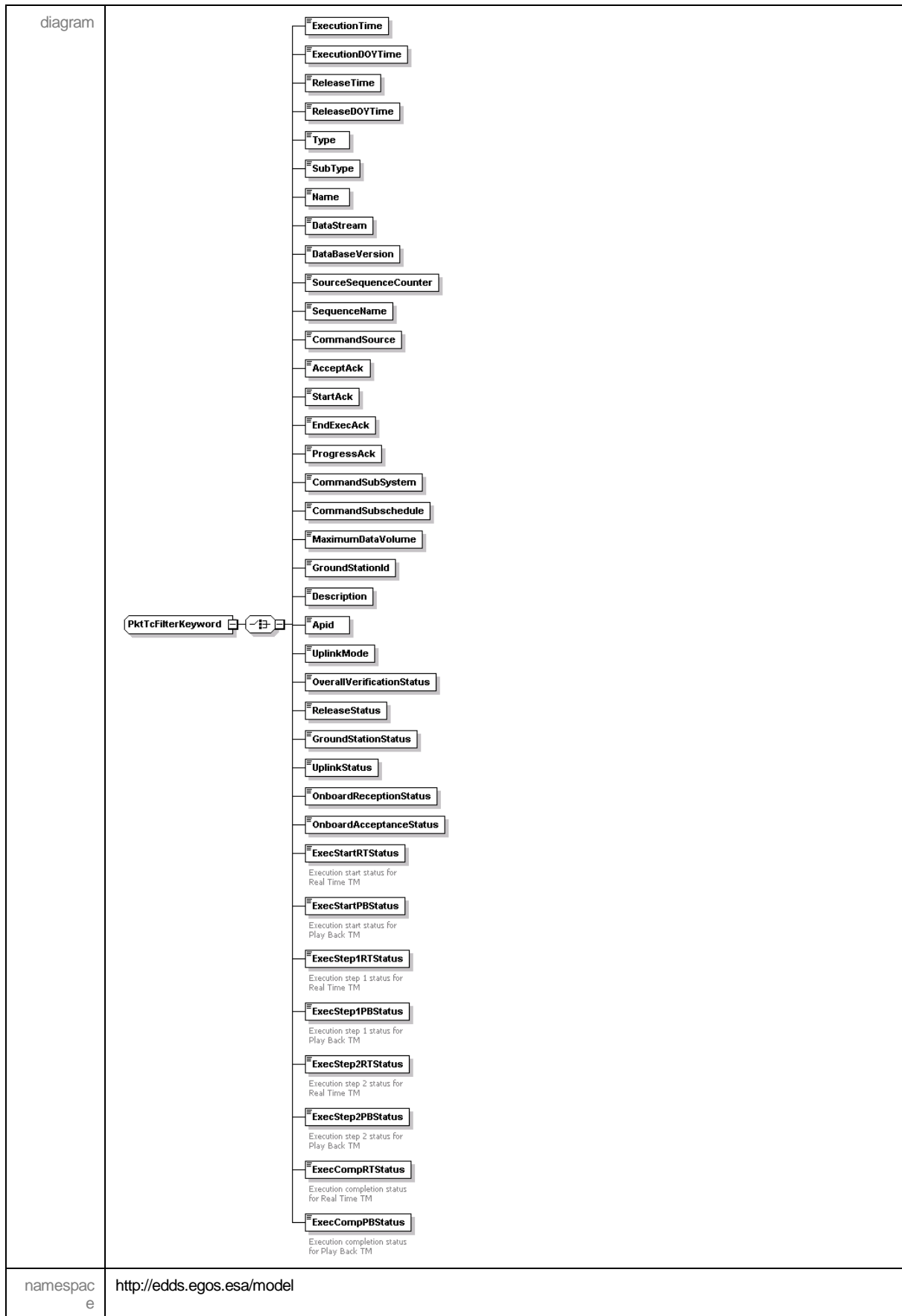



children	<a href="#">ExecutionTime</a> <a href="#">ExecutionDOYTime</a> <a href="#">ReleaseTime</a> <a href="#">ReleaseDOYTime</a> <a href="#">Type</a> <a href="#">SubType</a> <a href="#">Name</a> <a href="#">DataStream</a> <a href="#">DataBaseVersion</a> <a href="#">SourceSequenceCounter</a> <a href="#">SequenceName</a> <a href="#">CommandSource</a> <a href="#">AcceptAck</a> <a href="#">StartAck</a> <a href="#">EndExecAck</a> <a href="#">ProgressAck</a> <a href="#">CommandSubSystem</a> <a href="#">CommandSubschedule</a> <a href="#">MaximumDataVolume</a> <a href="#">GroundStationId</a> <a href="#">Description</a> <a href="#">Apid</a> <a href="#">UplinkMode</a> <a href="#">OverallVerificationStatus</a> <a href="#">ReleaseStatus</a> <a href="#">GroundStationStatus</a> <a href="#">UplinkStatus</a> <a href="#">OnboardReceptionStatus</a> <a href="#">OnboardAcceptanceStatus</a> <a href="#">ExecStartRTStatus</a> <a href="#">ExecStartPBStatus</a> <a href="#">ExecStep1RTStatus</a> <a href="#">ExecStep1PBStatus</a> <a href="#">ExecStep2RTStatus</a> <a href="#">ExecStep2PBStatus</a> <a href="#">ExecCompRTStatus</a> <a href="#">ExecCompPBStatus</a>
used by	element <b>TcFilterElement/PktTcFilterKeyword</b>

### G.34 complexType PktTcStreamFilterKeyword

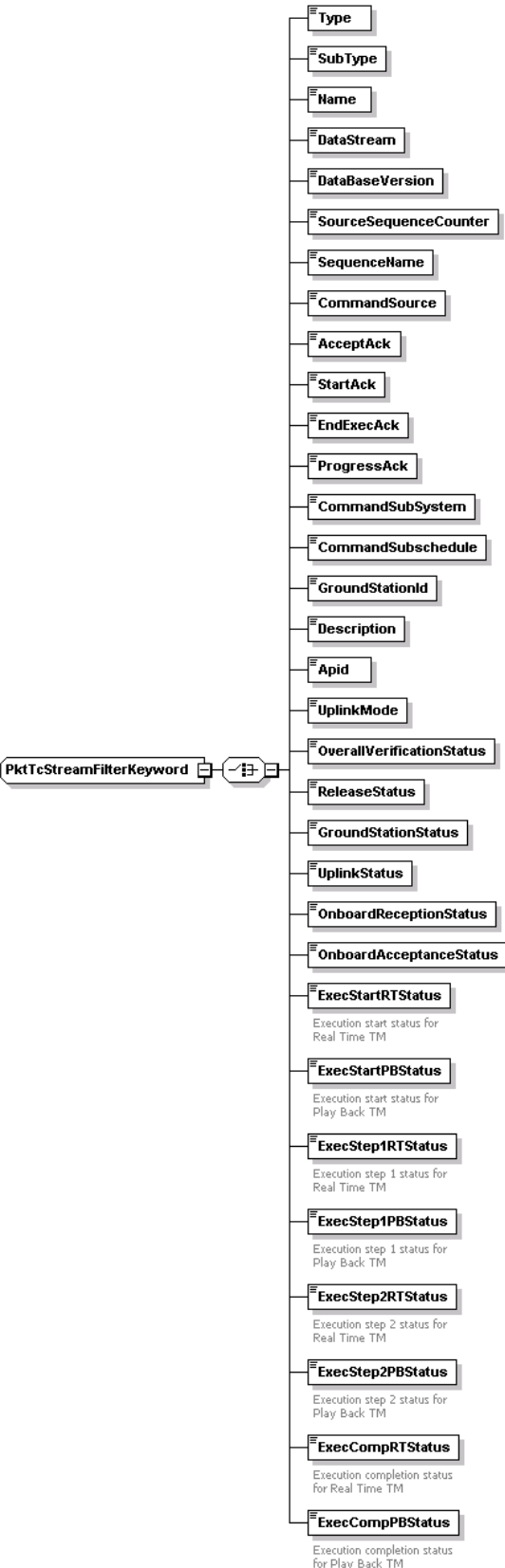
<p>diagram</p>	
<p>namespace</p>	<p><a href="http://edds.egos.esa/model">http://edds.egos.esa/model</a></p>
<p>children</p>	<p><a href="#">Type</a> <a href="#">SubType</a> <a href="#">Name</a> <a href="#">DataStream</a> <a href="#">DataBaseVersion</a> <a href="#">SourceSequenceCounter</a> <a href="#">SequenceName</a> <a href="#">CommandSource</a> <a href="#">AcceptAck</a> <a href="#">StartAck</a> <a href="#">EndExecAck</a> <a href="#">ProgressAck</a> <a href="#">CommandSubSystem</a></p>

	<a href="#">CommandSubschedule</a> <a href="#">GroundStationId</a> <a href="#">Description</a> <a href="#">Apid</a> <a href="#">UplinkMode</a> <a href="#">OverallVerificationStatus</a> <a href="#">ReleaseStatus</a> <a href="#">GroundStationStatus</a> <a href="#">UplinkStatus</a> <a href="#">OnboardReceptionStatus</a> <a href="#">OnboardAcceptanceStatus</a> <a href="#">ExecStartRTStatus</a> <a href="#">ExecStartPBStatus</a> <a href="#">ExecStep1RTStatus</a> <a href="#">ExecStep1PBStatus</a> <a href="#">ExecStep2RTStatus</a> <a href="#">ExecStep2PBStatus</a> <a href="#">ExecCompRTStatus</a> <a href="#">ExecCompPBStatus</a>
used by	element <b>TcStreamFilterListElement/PktTcStreamFilterKeyword</b>

### G.35 complexType PktTmFilterKeyword

diagram	<pre> classDiagram     class PktTmFilterKeyword     class GenerationTime     class GenerationDOYTime     class ExtractionTime     class ExtractionDOYTime     class TimeQuality     class VirtualChannel     class DataStream     class DataBaseVersion     class GroundStation     class SourceSequenceCounter     class MaximumDataVolume      PktTmFilterKeyword --&gt; GenerationTime     PktTmFilterKeyword --&gt; GenerationDOYTime     PktTmFilterKeyword --&gt; ExtractionTime     PktTmFilterKeyword --&gt; ExtractionDOYTime     PktTmFilterKeyword --&gt; TimeQuality     PktTmFilterKeyword --&gt; VirtualChannel     PktTmFilterKeyword --&gt; DataStream     PktTmFilterKeyword --&gt; DataBaseVersion     PktTmFilterKeyword --&gt; GroundStation     PktTmFilterKeyword --&gt; SourceSequenceCounter     PktTmFilterKeyword --&gt; MaximumDataVolume     </pre>
namespace	http://edds.egos.esa/model
children	<b>GenerationTime</b> <b>GenerationDOYTime</b> <b>ExtractionTime</b> <b>ExtractionDOYTime</b> <b>TimeQuality</b> <b>VirtualChannel</b> <b>DataStream</b> <b>DataBaseVersion</b> <b>GroundStation</b> <b>SourceSequenceCounter</b> <b>MaximumDataVolume</b>
used by	element <b>TmFilterElement/PktTmFilterKeyword</b>

### G.36 complexType PktTmGapReportFilter

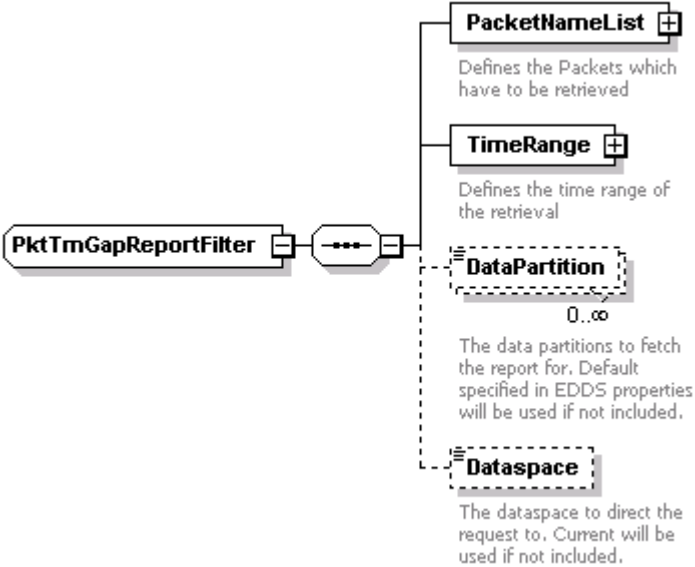
<p>diagram</p>	 <p><b>PacketNameList</b> +</p> <p>Defines the Packets which have to be retrieved</p> <p><b>TimeRange</b> +</p> <p>Defines the time range of the retrieval</p> <p><b>DataPartition</b> +</p> <p>0..∞</p> <p>The data partitions to fetch the report for. Default specified in EDDS properties will be used if not included.</p> <p><b>Dataspace</b> +</p> <p>The dataspace to direct the request to. Current will be used if not included.</p>
<p>namespace</p>	<p><a href="http://edds.egos.esa/model">http://edds.egos.esa/model</a></p>
<p>children</p>	<p><a href="#">PacketNameList</a> <a href="#">TimeRange</a> <a href="#">DataPartition</a> <a href="#">Dataspace</a></p>

### G.37 complexType PktTmStreamFilterKeyword

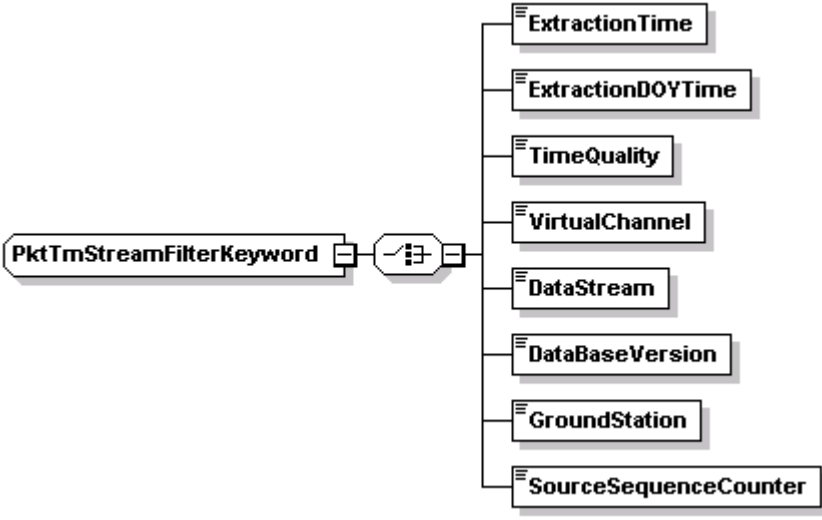
<p>diagram</p>	 <p><b>ExtractionTime</b> +</p> <p><b>ExtractionDOYTime</b> +</p> <p><b>TimeQuality</b> +</p> <p><b>VirtualChannel</b> +</p> <p><b>DataStream</b> +</p> <p><b>DataBaseVersion</b> +</p> <p><b>GroundStation</b> +</p> <p><b>SourceSequenceCounter</b> +</p>
<p>namespace</p>	<p><a href="http://edds.egos.esa/model">http://edds.egos.esa/model</a></p>
<p>children</p>	<p><b>ExtractionTime</b> <b>ExtractionDOYTime</b> <b>TimeQuality</b> <b>VirtualChannel</b> <b>DataStream</b> <b>DataBaseVersion</b> <b>GroundStation</b> <b>SourceSequenceCounter</b></p>
<p>used by</p>	<p>element <b>TmStreamFilterListElement/PktTmStreamFilterKeyword</b></p>

**G.38 complexType RawEvPacketFilter**

<p>diagram</p>	
<p>namespace</p>	<p>http://edds.egos.esa/model</p>
<p>type</p>	<p>extension of <b>RawPacketFilter</b></p>
<p>properties</p>	<p>base <b>RawPacketFilter</b></p>
<p>children</p>	<p><b>TimeRange Dataspace TimeFiltering</b></p>
<p>used by</p>	<p>complexType <b>RawTmPacketFilter</b></p>

**G.39 complexType RawPacketFilter**

<p>diagram</p>	
<p>namespace</p>	<p>http://edds.egos.esa/model</p>
<p>properties</p>	<p>abstract <b>true</b></p>
<p>children</p>	<p><b>TimeRange Dataspace</b></p>
<p>used by</p>	<p>complexTypes <b>RawEvPacketFilter RawTcPacketFilter</b></p>

### G.40 complexType RawTcPacketFilter

<p>diagram</p>	
<p>namespace</p>	<p>http://edds.egos.esa/model</p>
<p>type</p>	<p>extension of <b>RawPacketFilter</b></p>
<p>properties</p>	<p>base RawPacketFilter</p>
<p>children</p>	<p><b>TimeRange Dataspace TimeFiltering</b></p>

### G.41 complexType RawTmPacketFilter

<p>diagram</p>	
<p>namespace</p>	<p>http://edds.egos.esa/model</p>
<p>type</p>	<p>extension of <b>RawEvPacketFilter</b></p>
<p>properties</p>	<p>base RawEvPacketFilter</p>
<p>children</p>	<p><b>TimeRange Dataspace TimeFiltering PacketNameList</b></p>
<p>annotation</p>	<p>documentation Defines the extra filter elements needed for TM packets</p>

### G.42 complexType SMONParamFilter

diagram	<p>Defines the SMON Parameter Filter</p>
namespace	http://edds.egos.esa/model
children	ParamNameList TimeRange SMONParamFilterList
used by	element SMONParam/SMONParamFilter
annotation	documentation Defines the SMON Parameter Filter

### G.43 complexType SMONParamFilterKeyword

diagram	
namespace	http://edds.egos.esa/model
children	Validity DataStream PacketMnemonic ParameterValue NumericParameterValue OolState
used by	element SMONParamFilterListElement/SMONParamFilterKeyword

### G.44 complexType SMONParamFilterList

diagram	
namespace	http://edds.egos.esa/model
children	SMONParamFilterListElement
used by	element SMONParamFilter/SMONParamFilterList

### G.45 complexType SMONParamFilterListElement

diagram	
namespace	http://edds.egos.esa/model
children	SMONParamFilterKeyword Operation

used by	element <b>SMONParamFilterList/SMONParamFilterListElement</b>
---------	---

### G.46 complexType TcFilterElement

diagram	
namespace	http://edds.egos.esa/model
children	<b>PktTcFilterKeyword</b> <b>Operation</b>
used by	element <b>TcFilterList/TcFilterListElement</b>

### G.47 complexType TcFilterList

diagram	
namespace	http://edds.egos.esa/model
children	<b>TcFilterListElement</b>
used by	element <b>TcPacketFilter/TcFilterList</b>

### G.48 complexType TcPacketFilter

diagram	
namespace	http://edds.egos.esa/model
children	<b>TimeRange</b> <b>TimeFiltering</b> <b>TcFilterList</b> <b>Dataspace</b>

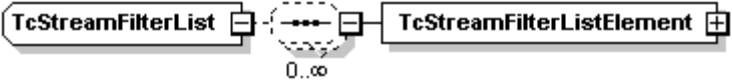

### G.49 complexType *TcStreamFilterList*

diagram	
namespace	http://edds.egos.esa/model
children	TcStreamFilterListElement

### G.50 complexType *TcStreamFilterListElement*

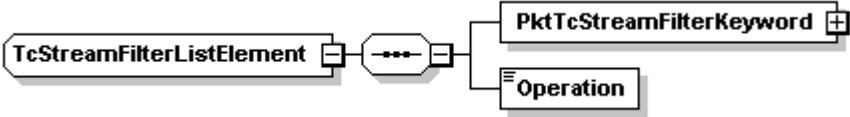
diagram	
namespace	http://edds.egos.esa/model
children	PktTcStreamFilterKeyword Operation
used by	element TcStreamFilterList/TcStreamFilterListElement

### G.51 complexType *TmFilterElement*

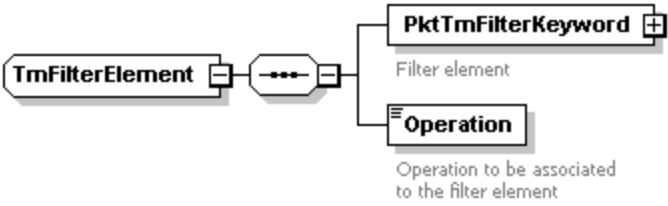
diagram	
namespace	http://edds.egos.esa/model
children	PktTmFilterKeyword Operation
used by	element TmFilterList/TmFilterListElement

### G.52 complexType *TmFilterList*

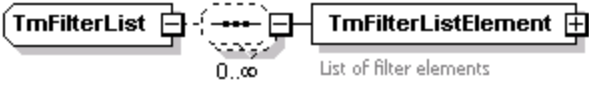
diagram	
namespace	http://edds.egos.esa/model
children	TmFilterListElement
used by	element TmPacketFilter/TmFilterList

### G.53 complexType TmPacketFilter

<p>diagram</p>	<p><b>PacketNameList</b> + Defines the Packets which have to be retrieved</p> <p><b>TimeRange</b> + Defines the time range of the retrieval</p> <p><b>TimeFiltering</b> = Defines the type of time retrieval</p> <p><b>TmFilterList</b> + 0..∞ Defines the list of filter option to be applied to the retrieved packets</p> <p><b>Dataspace</b> : The dataspace to direct the request to. Current will be used if not included.</p>
<p>namespace</p>	<p>http://edds.egos.esa/model</p>
<p>children</p>	<p><b>PacketNameList</b> <b>TimeRange</b> <b>TimeFiltering</b> <b>TmFilterList</b> <b>Dataspace</b></p>

### G.54 complexType TmStreamFilterList

<p>diagram</p>	
<p>namespace</p>	<p>http://edds.egos.esa/model</p>
<p>children</p>	<p><b>TmStreamFilterList</b></p>

### G.55 complexType TmStreamFilterListElement

<p>diagram</p>	
<p>namespace</p>	<p>http://edds.egos.esa/model</p>
<p>children</p>	<p><b>PktTmStreamFilterKeyword</b> <b>Operation</b></p>
<p>used by</p>	<p>element <b>TmStreamFilterList/TmStreamFilterList</b></p>

### G.56 simpleType CommandSource

<p>namespace</p>	<p>http://edds.egos.esa/model</p>
<p>type</p>	<p>restriction of <b>xs:string</b></p>

properties	base	xs:string
used by	element	<b>PktTcFilterKeyword/CommandSource</b>
facets	Kind	Value annotation
	enumeration	MANUAL_STACK
	enumeration	AUTO_STACK
	enumeration	EXT_SOURCE
	enumeration	TC_SPACON
	enumeration	OBQM_DISP
	enumeration	SMF_SOURCE
	enumeration	NAVPRS_STACK
	enumeration	MKMF_STACK
	enumeration	PKMF_STACK
	enumeration	SKMF_STACK

### G.57 simpleType StageStatus

namespace	http://edds.egos.esa/model		
type	restriction of <b>xs:string</b>		
properties	base	xs:string	
used by	elements	<b>PktTcFilterKeyword/ExecCompPBStatus PktTcStreamFilterKeyword/ExecCompPBStatus</b> <b>PktTcFilterKeyword/ExecCompRTStatus PktTcStreamFilterKeyword/ExecCompRTStatus</b> <b>PktTcFilterKeyword/ExecStartPBStatus PktTcStreamFilterKeyword/ExecStartPBStatus</b> <b>PktTcFilterKeyword/ExecStartRTStatus PktTcStreamFilterKeyword/ExecStartRTStatus</b> <b>PktTcFilterKeyword/ExecStep1PBStatus PktTcStreamFilterKeyword/ExecStep1PBStatus</b> <b>PktTcFilterKeyword/ExecStep1RTStatus PktTcStreamFilterKeyword/ExecStep1RTStatus</b> <b>PktTcFilterKeyword/ExecStep2PBStatus PktTcStreamFilterKeyword/ExecStep2PBStatus</b> <b>PktTcFilterKeyword/ExecStep2RTStatus PktTcStreamFilterKeyword/ExecStep2RTStatus</b> <b>PktTcFilterKeyword/GroundStationStatus PktTcStreamFilterKeyword/GroundStationStatus</b> <b>PktTcFilterKeyword/OnboardAcceptanceStatus</b> <b>PktTcStreamFilterKeyword/OnboardAcceptanceStatus</b> <b>PktTcFilterKeyword/OnboardReceptionStatus</b> <b>PktTcStreamFilterKeyword/OnboardReceptionStatus</b> <b>PktTcFilterKeyword/OverallVerificationStatus</b> <b>PktTcStreamFilterKeyword/OverallVerificationStatus PktTcFilterKeyword/ReleaseStatus</b> <b>PktTcStreamFilterKeyword/ReleaseStatus PktTcFilterKeyword/UplinkStatus</b> <b>PktTcStreamFilterKeyword/UplinkStatus</b>	
facets	Kind	Value	annotation
	enumeration		documentation
	enumeration	I	Not applicable documentation I for idle
	enumeration	P	documentation P for pending
	enumeration	S	documentation S for success
	enumeration	F	documentation F for failed
	enumeration	U	documentation U for unverified
	enumeration	X	documentation X for unknown
	enumeration	T	documentation T for timeout
	enumeration	E	documentation E for superseded
	enumeration	N	documentation N for uncertain failed
	enumeration	V	documentation V for uncertain successful
	enumeration	C	documentation C for affected
	enumeration	D	documentation D for disabled
	enumeration	A	documentation

	A for assumed passed
--	----------------------

### G.58 simpleType TcTimeFiltering

namespace	http://edds.egos.esa/model		
type	restriction of <b>xs:string</b>		
properties	base <b>xs:string</b>		
used by	elements	<b>TcPacketFilter/TimeFiltering RawTcPacketFilter/TimeFiltering</b>	
facets	Kind	Value	annotation
	enumeration	RELEASE_TIME	documentation Command release time of the packet (Primary Key)
	enumeration	EXECUTION_TIME	documentation Predicted or actual execution time of the packet (Secondary Key)

### G.59 simpleType TimeFiltering

namespace	http://edds.egos.esa/model		
type	restriction of <b>xs:string</b>		
properties	base <b>xs:string</b>		
used by	elements	<b>EvPacketFilter/TimeFiltering OolDataReportFilter/TimeFiltering TmPacketFilter/TimeFiltering RawEvPacketFilter/TimeFiltering</b>	
facets	Kind	Value	annotation
	enumeration	GENERATION_TIME	documentation On board Time of the packet (Primary Key)
	enumeration	STORAGE_TIME	documentation Reception time of the packet into the archive (Secondary Key)

### G.60 simpleType UplinkMode

namespace	http://edds.egos.esa/model		
type	restriction of <b>xs:string</b>		
properties	base <b>xs:string</b>		
used by	elements	<b>PktTcFilterKeyword/UplinkMode PktTcStreamFilterKeyword/UplinkMode</b>	
facets	Kind	Value	annotation
	enumeration	A	documentation AD transmission mode
	enumeration	B	documentation BD transmission mode

## Appendix H Format Data Type

### H.1 group *SplittableFormat*

diagram	 <p>Defines the base properties for splittable formats.</p>
namespace	http://edds.egos.esa/model
children	<b>SplitFileSize</b>
annotation	documentation Defines the base properties for splittable formats.

This section of the document describes the format types as defined in the format.xsd file.

### H.2 complexType *CatalogueFormatting*

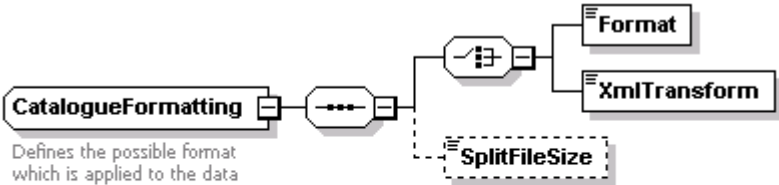
diagram	 <p>Defines the possible format which is applied to the data response. The split file size only applies to formats that can be split and is in megabytes. If omitted, the default from EDDS Server is taken.</p>
namespace	http://edds.egos.esa/model
children	<b>Format XmlTransform SplitFileSize</b>
annotation	documentation Defines the possible format which is applied to the data response.

### H.3 complexType *EddsUsageReportFormatting*

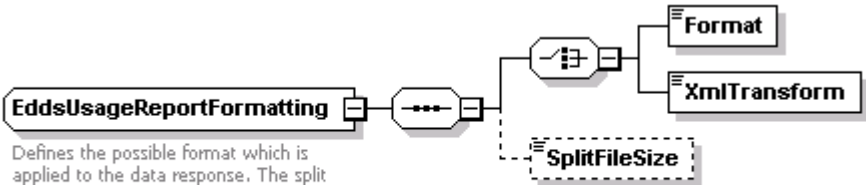
diagram	 <p>Defines the possible format which is applied to the data response. The split file size only applies to formats that can be split and is in megabytes. If omitted, the default from EDDS Server is taken.</p>
namespace	http://edds.egos.esa/model
children	<b>Format XmlTransform SplitFileSize</b>
annotation	documentation Defines the possible format which is applied to the data response.

#### H.4 complexType EvPacketFormatting

diagram	<p>Defines the possible format which is applied to the data response. The split file size only applies to formats that can be split and is in megabytes. If omitted, the default from EDDS Server is taken.</p>
namespace	http://edds.egos.esa/model
children	<a href="#">Format</a> <a href="#">SplitFileSize</a>
annotation	documentation Defines the possible format which is applied to the data response. The split file size only applies to formats that can be split and is in megabytes. If omitted, the default from EDDS Server is taken.

#### H.5 complexType PacketFormatting

diagram	<p>Defines the possible format which is applied to the data response. The split file size only applies to formats that can be split and is in megabytes. If omitted, the default from EDDS Server is taken.</p>
namespace	http://edds.egos.esa/model
children	<a href="#">Format</a> <a href="#">XmlTransform</a> <a href="#">SplitFileSize</a>
annotation	documentation Defines the possible format which is applied to the data response. The split file size only applies to formats that can be split and is in megabytes. If omitted, the default from EDDS Server is taken.

#### H.6 complexType PacketStatisticsFormatting

diagram	<p>Defines the possible format which is applied to the data response. The split file size only applies to formats that can be split and is in megabytes. If omitted, the default from EDDS Server is taken.</p>
namespace	http://edds.egos.esa/model
children	<a href="#">Format</a> <a href="#">XmlTransform</a> <a href="#">SplitFileSize</a>
annotation	documentation Defines the possible format which is applied to the data response.

## H.7 complexType ParamDefinitionFormatting

diagram	<p>Defines the possible format which is applied to the data response. The split file size only applies to formats that can be split and is in megabytes. If omitted, the default from EDDS Server is taken.</p>
namespace	http://edds.egos.esa/model
children	<b>Format XmlTransform SplitFileSize</b>
annotation	documentation Defines the possible format which is applied to the data response.

## H.8 complexType ParamPreviewFormatting

diagram	<p>Defines the possible format which is applied to the data response. The split file size only applies to formats that can be split and is in megabytes. If omitted, the default from EDDS Server is taken.</p>
namespace	http://edds.egos.esa/model
children	<b>Format XmlTransform SplitFileSize</b>
annotation	documentation Defines the possible format which is applied to the data response.

## H.9 complexType ParamStatisticsFormatting

diagram	<p>Defines the possible format which is applied to the data response. The split file size only applies to formats that can be split and is in megabytes. If omitted, the default from EDDS Server is taken.</p>
namespace	http://edds.egos.esa/model
children	<b>Format XmlTransform SplitFileSize</b>
annotation	documentation Defines the possible format which is applied to the data response.

**H.10 complexType ParamTmFormatting**

diagram	<p>Defines the possible format which is applied to the data response. The split file size only applies to formats that can be split and is in megabytes. If omitted, the default from EDDS Server is taken.</p>
namespace	http://edds.egos.esa/model
children	<b>Format XmlTransform SplitFileSize</b>
annotation	documentation Defines the possible format which is applied to the data response.

**H.11 complexType ParcRawPacketFormatting**

diagram	<p>Defines the possible format which is applied to the data response. The split file size only applies to formats that can be split and is in megabytes. If omitted, the default from EDDS Server is taken.</p>
namespace	http://edds.egos.esa/model
children	<b>Format XmlTransform SplitFileSize</b>
annotation	documentation Defines the possible format which is applied to the data response.

**H.12 complexType ReportFormatting**

diagram	<p>Defines the possible format which is applied to the data response. The split file size only applies to formats that can be split and is in megabytes. If omitted, the default from EDDS Server is taken.</p>
namespace	http://edds.egos.esa/model
children	<b>Format XmlTransform SplitFileSize</b>
annotation	documentation Defines the possible format which is applied to the data response.



### H.13 complexType SMONParamFormatting

diagram	<p>Defines the possible format which is applied to the data response. The split file size only applies to formats that can be split and is in megabytes. If omitted, the default from EDDS Server is taken.</p>
namespace	http://edds.egos.esa/model
children	<b>Format XmlTransform SplitFileSize</b>
annotation	documentation Defines the possible format which is applied to the data response.

### H.14 simpleType ArchiveFileFormat

namespace	http://edds.egos.esa/model
type	restriction of <b>xs:string</b>
properties	base <b>xs:string</b>
facets	Kind enumeration Value <b>BINARY</b> annotation
annotation	documentation Defines the list of supported format of the data response.

### H.15 simpleType CatalogueFormat

namespace	http://edds.egos.esa/model
type	restriction of <b>xs:string</b>
properties	base <b>xs:string</b>
used by	element <b>CatalogueFormatting/Format</b>
facets	Kind enumeration Value <b>XML</b> enumeration <b>ASCII</b> annotation
annotation	documentation Defines the list of supported format of the data response.

### H.16 simpleType EddsUsageReportFormat

namespace	http://edds.egos.esa/model
type	restriction of <b>xs:string</b>
properties	base <b>xs:string</b>
used by	element <b>EddsUsageReportFormatting/Format</b>
facets	Kind enumeration Value <b>XML</b> annotation
annotation	documentation Defines the list of supported format of the data response.

**H.17 simpleType EvPacketFormat**

namespace	http://edds.egos.esa/model
type	restriction of <b>xs:string</b>
properties	base xs:string
facets	Kind Value annotation enumeration EDDS_RAW
annotation	documentation Defines the list of supported format of the data response.

**H.18 simpleType PacketFormat**

namespace	http://edds.egos.esa/model
type	restriction of <b>xs:string</b>
properties	base xs:string
facets	Kind Value annotation enumeration EDDS_RAW enumeration SFDU enumeration GDDS_BINARY
annotation	documentation Defines the list of supported format of the data response.

**H.19 simpleType PacketStatisticsFormat**

namespace	http://edds.egos.esa/model
type	restriction of <b>xs:string</b>
properties	base xs:string
used by	element <b>PacketStatisticsFormatting/Format</b>
facets	Kind Value annotation enumeration XML
annotation	documentation Defines the list of supported format of the data response.

**H.20 simpleType ParamDefinitionFormat**

namespace	http://edds.egos.esa/model
type	restriction of <b>xs:string</b>
properties	base xs:string
used by	element <b>ParamDefinitionFormatting/Format</b>
facets	Kind Value annotation enumeration XML enumeration BINARY
annotation	documentation Defines the list of supported format of the data response.

**H.21 simpleType ParamPreviewFormat**

namespace	http://edds.egos.esa/model
type	restriction of <b>xs:string</b>
properties	base xs:string
used by	element <b>ParamPreviewFormatting/Format</b>
facets	Kind Value annotation enumeration XML enumeration ASCII
annotation	documentation Defines the list of supported format of the data response.

**H.22 simpleType ParamStatisticsFormat**

namespace	http://edds.egos.esa/model
type	restriction of <b>xs:string</b>
properties	base xs:string
used by	element <b>ParamStatisticsFormatting/Format</b>
facets	Kind Value annotation enumeration XML enumeration ASCII
annotation	documentation Defines the list of supported format of the data response.

**H.23 simpleType ParamTmFormat**

namespace	http://edds.egos.esa/model
type	restriction of <b>xs:string</b>
properties	base xs:string
used by	element <b>ParamTmFormatting/Format</b>
facets	Kind Value annotation enumeration XML documentation XML format enumeration TDRS documentation TDRS spreadsheet format
annotation	documentation Defines the list of supported format of the data response.

**H.24 simpleType ParcRawPacketFormat**

namespace	http://edds.egos.esa/model
type	restriction of <b>xs:string</b>
properties	base xs:string
used by	element <b>ParcRawPacketFormatting/Format</b>
facets	Kind Value annotation enumeration XML

	enumeration BINARY
annotation	documentation Defines the list of supported format of the data response.

### ***H.25 simpleType ReportFormat***

namespace	http://edds.egos.esa/model		
type	restriction of <b>xs:string</b>		
properties	base xs:string		
used by	element <b>ReportFormatting/Format</b>		
facets	Kind	Value	annotation
	enumeration	XML	
	enumeration	ASCII	
	enumeration	BINARY	
annotation	documentation Defines the list of supported format of the data response.		

### ***H.26 simpleType SMONParamFormat***

namespace	http://edds.egos.esa/model		
type	restriction of <b>xs:string</b>		
properties	base xs:string		
used by	element <b>SMONParamFormatting/Format</b>		
facets	Kind	Value	annotation
	enumeration	XML	documentation XML format
	enumeration	DARC_XML	documentation DARC XML format
	enumeration	DARC_BINARY	documentation DARC binary format
	enumeration	TDRS	documentation TDRS spreadsheet format
	enumeration	BINARY	documentation Binary format
annotation	documentation Defines the list of supported format of the data response.		

## Appendix I Report Data Type

This section of the document describes the report complex types as defined in the report.xsd file.

### I.1 complexType DataRequestBase

diagram	<p><b>DataRequestBase</b> Base class for all batch requests (including report requests)</p> <p><b>DataSource</b> Defines the data source associated with the request</p> <p><b>RequestPostProcessing</b> Defines if the request response has to be compressed or and encrypted.</p> <p><b>Delivery</b> Defines the mechanism used to deliver the data response to the user.</p>
namespace	http://edds.egos.esa/model
children	<b>DataSource RequestPostProcessing Delivery</b>
used by	complexTypees <a href="#">EddsUsageReport</a> <a href="#">EventRecordReport</a> <a href="#">OolRecordReport</a> <a href="#">PktTcReport</a> <a href="#">PktTmReport</a>
annotation	documentation Base class for all batch requests (including report requests)

### I.2 complexType EddsUsageReport

diagram	<p><b>EddsUsageReport</b> Defines the Edds Usage report</p> <p><b>DataRequestBase (extension)</b></p> <p><b>DataSource</b> Defines the data source associated with the request</p> <p><b>RequestPostProcessing</b> Defines if the request response has to be compressed or and encrypted.</p> <p><b>Delivery</b> Defines the mechanism used to deliver the data response to the user.</p> <p><b>EddsUsageReportFilter</b> Defines the Edds Usage Report Filter</p> <p><b>EddsUsageReportFormat</b> Defines the possible format which is applied to the data response.</p>
namespace	http://edds.egos.esa/model
type	extension of <a href="#">DataRequestBase</a>
properties	base <a href="#">DataRequestBase</a>

children	<b>DataSource RequestPostProcessing Delivery EddsUsageReportFilter EddsUsageReportFormat</b>
annotation	documentation Defines the Edds Usage report

### I.3 complexType EddsUsageReportList

diagram	<p>A list of Edds usage elements</p>
namespace	http://edds.egos.esa/model
children	<b>EddsUsageReportListElement</b>
used by	element <b>EddsUsageReportResponse/EddsUsageReportList</b>
annotation	documentation A list of Edds usage elements

### I.4 complexType EddsUsageReportListElement

diagram	
namespace	http://edds.egos.esa/model

children	<b>RequestId User Role Status ReasonForFailure SizeOfResponseFile SubmissionDate ExecutionDate CompletionDate</b>
used by	element <b>EddsUsageReportList/EddsUsageReportListElement</b>

**1.5 complexType EddsUsageReportResponse**

diagram	
namespace	http://edds.egos.esa/model
children	<b>TotalDeletedRequests TotalProcessedRequests TotalFailedRequests EddsUsageReportList</b>

### 1.6 complexType EventRecordReport

<p>diagram</p>	<p>The diagram illustrates the structure of the <b>EventRecordReport</b> complex type. It is defined as an extension of <b>DataRequestBase</b>. The <b>DataRequestBase</b> complex type contains three elements: <b>DataSource</b> (Defines the data source associated with the request), <b>RequestPostProcessing</b> (Defines if the request response has to be compressed or and encrypted), and <b>Delivery</b> (Defines the mechanism used to deliver the data response to the user). The <b>EventRecordReport</b> complex type includes a filter property and is associated with <b>EvPacketFilter</b> (Defines the basic information necessary to retrieve the data from the Report and defines the filter to be applied to the retrieved data.) and <b>ReportFormat</b> (Defines the possible format which is applied to the data response.).</p>
<p>namespace</p>	<p>http://edds.egos.esa/model</p>
<p>type</p>	<p>extension of <a href="#">DataRequestBase</a></p>
<p>properties</p>	<p>base DataRequestBase</p>
<p>children</p>	<p><b>DataSource RequestPostProcessing Delivery EvPacketFilter ReportFormat</b></p>
<p>annotation</p>	<p>documentation Defines filter to be applied for the Ev report</p>

### 1.7 complexType EventRecordReportList

<p>diagram</p>	<p>The diagram shows the <b>EventRecordReportList</b> complex type as a list of <b>EventRecordReportListElement</b> elements. The list is represented by a dashed box containing a solid box and the cardinality <b>0..∞</b>.</p>
<p>namespace</p>	<p>http://edds.egos.esa/model</p>
<p>children</p>	<p><b>EventRecordReportListElement</b></p>
<p>used by</p>	<p>element <b>EventRecordReportResponse/EventRecordReportList</b></p>
<p>annotation</p>	<p>documentation A list of EV packets</p>



### 1.8 complexType EventRecordReportListElement

<p>diagram</p>	<p>The diagram shows the structure of the <b>EventRecordReportListElement</b> complex type. It consists of a sequence of the following child elements:</p> <ul style="list-style-type: none"> <li><b>Id</b>: The name of the event</li> <li><b>Category</b>: The category of the event</li> <li><b>Domain</b>: The domain of the event</li> <li><b>EventId</b>: The event ID of the event</li> <li><b>EventType</b>: The event type of the event</li> <li><b>GenerationTime</b>: The generation time of the event</li> <li><b>Source</b>: The source of the event</li> <li><b>Application</b>: The application of the event</li> <li><b>Severity</b>: The severity of the event</li> <li><b>Type</b>: The type of the event</li> <li><b>Workstation</b>: The workstation of the event</li> <li><b>Message</b>: The message of the event</li> </ul>
<p>namespace</p>	<p><a href="http://edds.egos.esa/model">http://edds.egos.esa/model</a></p>
<p>children</p>	<p><a href="#">Id</a> <a href="#">Category</a> <a href="#">Domain</a> <a href="#">EventId</a> <a href="#">EventType</a> <a href="#">GenerationTime</a> <a href="#">Source</a> <a href="#">Application</a> <a href="#">Severity</a> <a href="#">Type</a> <a href="#">Workstation</a> <a href="#">Message</a></p>
<p>used by</p>	<p>element <b>EventRecordReportList/EventRecordReportListElement</b></p>

### 1.9 complexType EventRecordReportResponse

<p>diagram</p>	<p>The diagram shows the structure of the <b>EventRecordReportResponse</b> complex type. It consists of a single child element:</p> <ul style="list-style-type: none"> <li><b>EventRecordReportList</b>: Defines the context of the request.</li> </ul>
<p>namespace</p>	<p><a href="http://edds.egos.esa/model">http://edds.egos.esa/model</a></p>
<p>children</p>	<p><b>EventRecordReportList</b></p>

### I.10 complexType *OolDataReportList*

diagram	<p>Defines the list of OOL Data Report responses</p> <p>0..∞</p> <p>Defines the OOL Data Report response element</p>
namespace	http://edds.egos.esa/model
children	<b>OolDataReportResponseElement</b>
used by	element <b>OolDataReportResponse/OolDataReportList</b>
annotation	documentation Defines the list of OOL Data Report responses

### I.11 complexType *OolDataReportResponse*

diagram	<p>Defines the context of the request.</p>
namespace	http://edds.egos.esa/model
children	<b>OolDataReportList</b>

**I.12 complexType OolDataReportResponseElement**

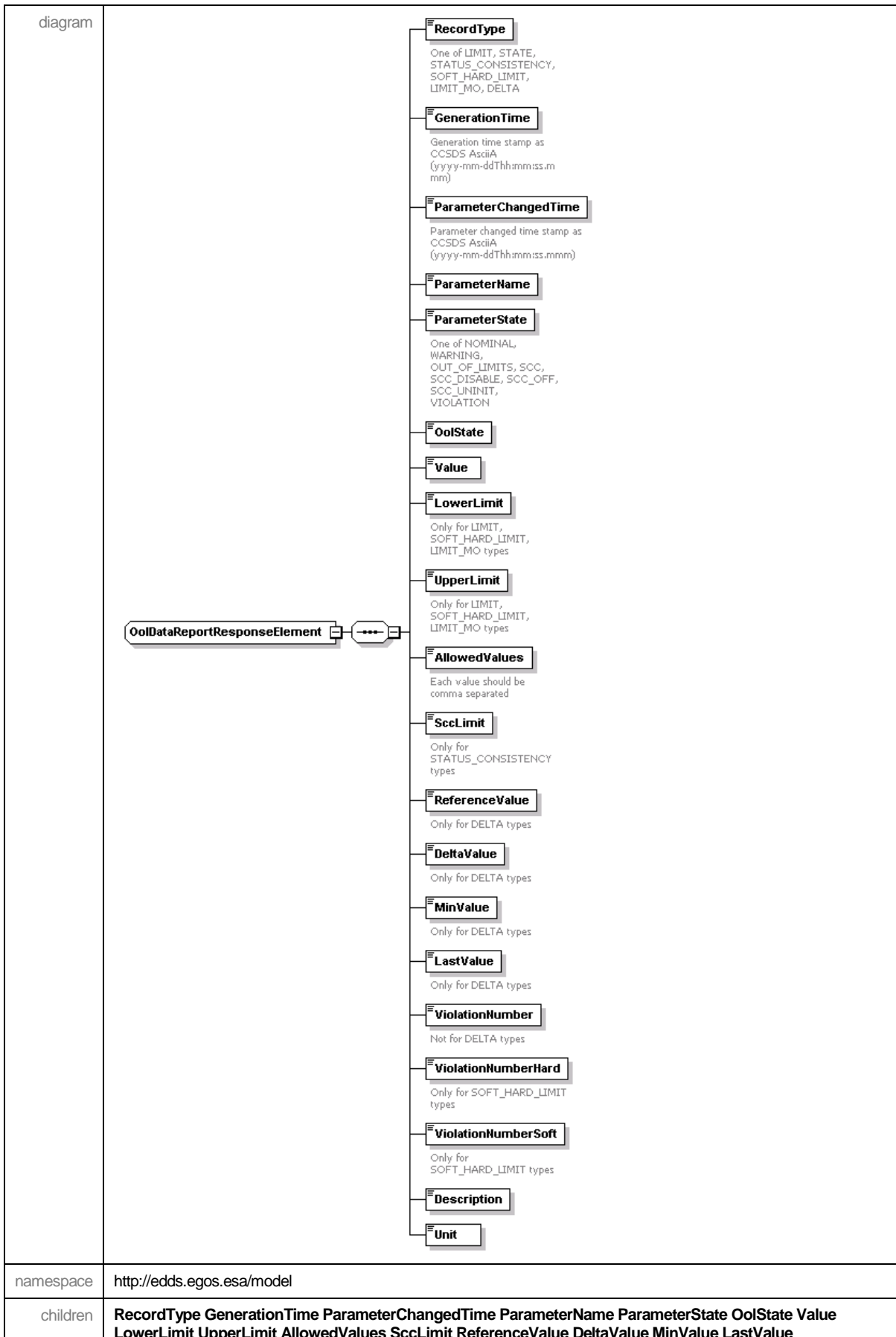

	<b>ViolationNumber ViolationNumberHard ViolationNumberSoft Description Unit</b>
used by	element <b>OolDataReportList/OolDataReportResponseElement</b>

### I.13 complexType OolRecordReport

diagram	<pre> classDiagram     class OolRecordReport {         +DataSource         +RequestPostProcessing         +Delivery         +OolDataReportFilter         +ReportFormat     }     class DataRequestBase {         +DataSource         +RequestPostProcessing         +Delivery     }     class DataSource {         +DataSource     }     class RequestPostProcessing {         +RequestPostProcessing     }     class Delivery {         +Delivery     }     class OolDataReportFilter {         +OolDataReportFilter     }     class ReportFormat {         +ReportFormat     }     OolRecordReport -- &gt; DataRequestBase     DataRequestBase -- &gt; BaseClass     OolRecordReport -- DataSource     OolRecordReport -- RequestPostProcessing     OolRecordReport -- Delivery     OolRecordReport -- OolDataReportFilter     OolRecordReport -- ReportFormat     </pre> <p>The diagram shows the structure of the <b>OolRecordReport</b> complex type. It is an extension of <b>DataRequestBase</b>. <b>DataRequestBase</b> is an extension of an unspecified base class and contains three child elements: <b>DataSource</b>, <b>RequestPostProcessing</b>, and <b>Delivery</b>. <b>OolRecordReport</b> contains five child elements: <b>DataSource</b>, <b>RequestPostProcessing</b>, <b>Delivery</b>, <b>OolDataReportFilter</b>, and <b>ReportFormat</b>.</p>
namespace	http://edds.egos.esa/model
type	extension of <a href="#">DataRequestBase</a>
properties	base DataRequestBase
children	<b>DataSource RequestPostProcessing Delivery OolDataReportFilter ReportFormat</b>
annotation	documentation Defines the Ool data report

### I.14 complexType PktTcReport

<p>diagram</p>	<pre> classDiagram     class PktTcReport {         &lt;u&gt;DataRequestBase&lt;/u&gt;         &lt;u&gt;PktTcReportFilter&lt;/u&gt;     }     class DataRequestBase {         &lt;u&gt;DataSource&lt;/u&gt;         &lt;u&gt;RequestPostProcessing&lt;/u&gt;         &lt;u&gt;Delivery&lt;/u&gt;     }     class PktTcReportFilter {         &lt;u&gt;TcPacketFilter&lt;/u&gt;         &lt;u&gt;ReportFormat&lt;/u&gt;         &lt;u&gt;BriefReportFlag&lt;/u&gt;     }     PktTcReport ..&gt; DataRequestBase     PktTcReport ..&gt; PktTcReportFilter     </pre> <p><b>DataRequestBase (extension)</b></p> <ul style="list-style-type: none"> <li><b>DataSource</b>: Defines the data source associated with the request</li> <li><b>RequestPostProcessing</b>: Defines if the request response has to be compressed or and encrypted.</li> <li><b>Delivery</b>: Defines the mechanism used to deliver the data response to the user.</li> </ul> <p><b>PktTcReport</b>: Defines filter to be applied for the TC report</p> <ul style="list-style-type: none"> <li><b>TcPacketFilter</b>: Defines the basic information necessary to retrieve the data from the Report and defines the filter to be applied to the retrieved data.</li> <li><b>ReportFormat</b>: Defines the possible format which is applied to the data response.</li> <li><b>BriefReportFlag</b>: Describes whether to get a brief report only (with no parameter lists) or not. If false, a full report is fetched.</li> </ul>
<p>namespace</p>	<p>http://edds.egos.esa/model</p>
<p>type</p>	<p>extension of <a href="#">DataRequestBase</a></p>
<p>properties</p>	<p>base DataRequestBase</p>
<p>children</p>	<p><b>DataRequestBase RequestPostProcessing Delivery TcPacketFilter ReportFormat BriefReportFlag</b></p>
<p>annotation</p>	<p>documentation Defines filter to be applied for the TC report</p>

### I.15 complexType PktTcReportList

<p>diagram</p>	<pre> classDiagram     class PktTcReportList {         &lt;u&gt;PktTcReportListElement&lt;/u&gt;     }     PktTcReportList ..&gt; PktTcReportListElement     </pre> <p><b>PktTcReportList</b>: A list of TC packets</p> <p><b>PktTcReportListElement</b></p>
<p>namespace</p>	<p>http://edds.egos.esa/model</p>
<p>children</p>	<p><b>PktTcReportListElement</b></p>
<p>used by</p>	<p>element <b>PktTcReportResponse/PktTcReportList</b></p>
<p>annotation</p>	<p>Documentation A list of TC packets</p>

### I.16 complexType PktTcReportListElement

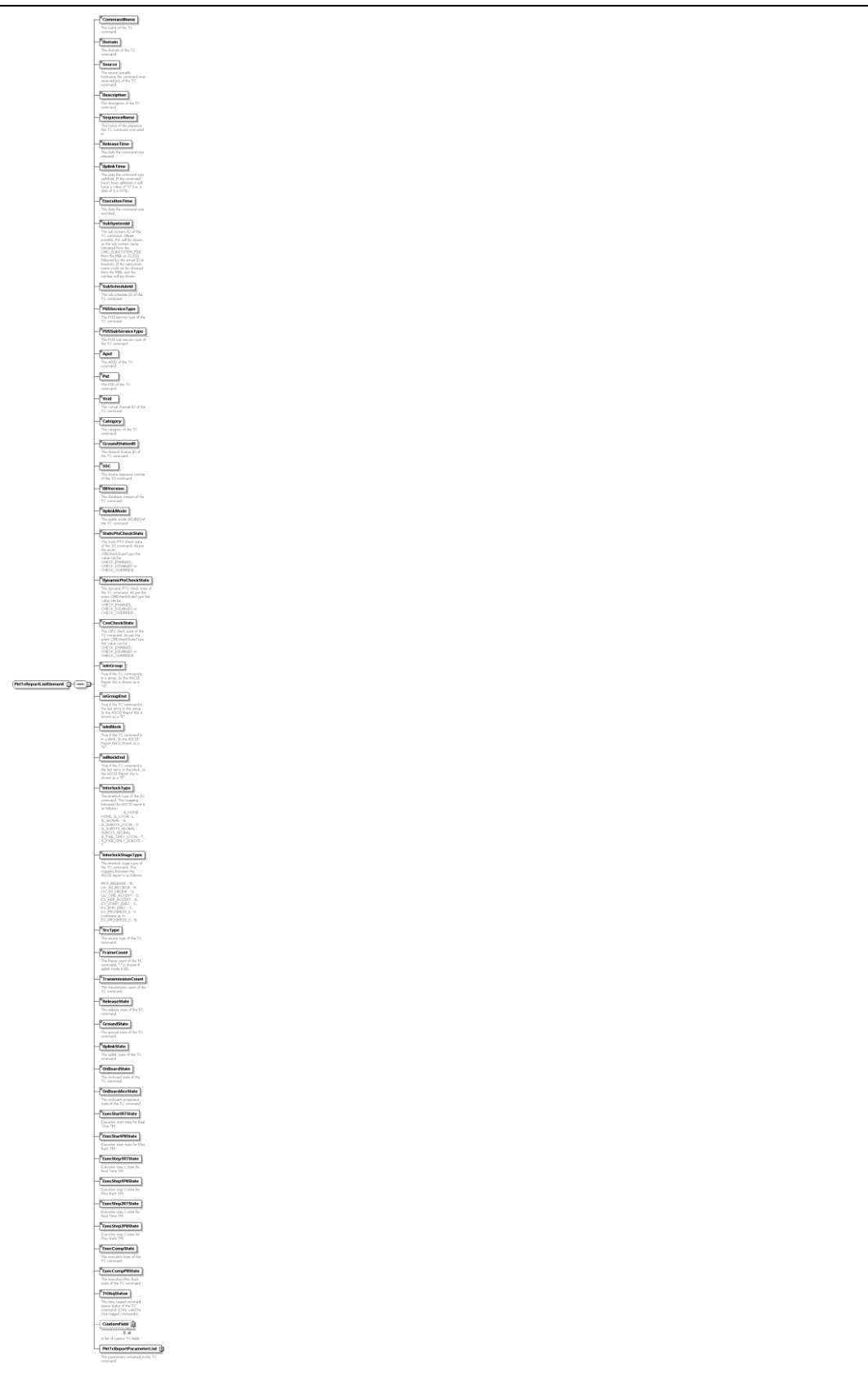
<p>diagram</p> 	<p><b>CommandName</b> The command name of the TC element.</p> <p><b>ReleaseTime</b> The release time of the TC element.</p> <p><b>UplinkTime</b> The uplink time of the TC element.</p> <p><b>ExecutionTime</b> The execution time of the TC element.</p> <p><b>SubSystemId</b> The subsystem ID of the TC element.</p> <p><b>SubScheduleId</b> The sub-schedule ID of the TC element.</p> <p><b>PUSServiceType</b> The PUS service type of the TC element.</p> <p><b>PUSSubServiceType</b> The PUS sub-service type of the TC element.</p> <p><b>ApId</b> The AP ID of the TC element.</p> <p><b>Pid</b> The PID of the TC element.</p> <p><b>Vcid</b> The VC ID of the TC element.</p> <p><b>Category</b> The category of the TC element.</p> <p><b>GroundStationId</b> The ground station ID of the TC element.</p> <p><b>SSC</b> The SSC of the TC element.</p> <p><b>DBVersion</b> The DB version of the TC element.</p> <p><b>UplinkMode</b> The uplink mode of the TC element.</p> <p><b>StaticPtvCheckState</b> The static PTV check state of the TC element.</p> <p><b>DynamicPtvCheckState</b> The dynamic PTV check state of the TC element.</p> <p><b>CevCheckState</b> The CEV check state of the TC element.</p> <p><b>PktTcReportListElement</b> →</p> <p><b>ReleaseTime</b> The release time of the TC element.</p> <p><b>UplinkTime</b> The uplink time of the TC element.</p> <p><b>ExecutionTime</b> The execution time of the TC element.</p> <p><b>SubSystemId</b> The subsystem ID of the TC element.</p> <p><b>SubScheduleId</b> The sub-schedule ID of the TC element.</p> <p><b>PUSServiceType</b> The PUS service type of the TC element.</p> <p><b>PUSSubServiceType</b> The PUS sub-service type of the TC element.</p> <p><b>ApId</b> The AP ID of the TC element.</p> <p><b>Pid</b> The PID of the TC element.</p> <p><b>Vcid</b> The VC ID of the TC element.</p> <p><b>Category</b> The category of the TC element.</p> <p><b>GroundStationId</b> The ground station ID of the TC element.</p> <p><b>SSC</b> The SSC of the TC element.</p> <p><b>DBVersion</b> The DB version of the TC element.</p> <p><b>UplinkMode</b> The uplink mode of the TC element.</p> <p><b>StaticPtvCheckState</b> The static PTV check state of the TC element.</p> <p><b>DynamicPtvCheckState</b> The dynamic PTV check state of the TC element.</p> <p><b>CevCheckState</b> The CEV check state of the TC element.</p> <p><b>CommandName</b> The command name of the TC element.</p> <p><b>ReleaseTime</b> The release time of the TC element.</p> <p><b>UplinkTime</b> The uplink time of the TC element.</p> <p><b>ExecutionTime</b> The execution time of the TC element.</p> <p><b>SubSystemId</b> The subsystem ID of the TC element.</p> <p><b>SubScheduleId</b> The sub-schedule ID of the TC element.</p> <p><b>PUSServiceType</b> The PUS service type of the TC element.</p> <p><b>PUSSubServiceType</b> The PUS sub-service type of the TC element.</p> <p><b>ApId</b> The AP ID of the TC element.</p> <p><b>Pid</b> The PID of the TC element.</p> <p><b>Vcid</b> The VC ID of the TC element.</p> <p><b>Category</b> The category of the TC element.</p> <p><b>GroundStationId</b> The ground station ID of the TC element.</p> <p><b>SSC</b> The SSC of the TC element.</p> <p><b>DBVersion</b> The DB version of the TC element.</p> <p><b>UplinkMode</b> The uplink mode of the TC element.</p> <p><b>StaticPtvCheckState</b> The static PTV check state of the TC element.</p> <p><b>DynamicPtvCheckState</b> The dynamic PTV check state of the TC element.</p> <p><b>CevCheckState</b> The CEV check state of the TC element.</p> <p><b>CommandName</b> The command name of the TC element.</p> <p><b>ReleaseTime</b> The release time of the TC element.</p> <p><b>UplinkTime</b> The uplink time of the TC element.</p> <p><b>ExecutionTime</b> The execution time of the TC element.</p> <p><b>SubSystemId</b> The subsystem ID of the TC element.</p> <p><b>SubScheduleId</b> The sub-schedule ID of the TC element.</p> <p><b>PUSServiceType</b> The PUS service type of the TC element.</p> <p><b>PUSSubServiceType</b> The PUS sub-service type of the TC element.</p> <p><b>ApId</b> The AP ID of the TC element.</p> <p><b>Pid</b> The PID of the TC element.</p> <p><b>Vcid</b> The VC ID of the TC element.</p> <p><b>Category</b> The category of the TC element.</p> <p><b>GroundStationId</b> The ground station ID of the TC element.</p> <p><b>SSC</b> The SSC of the TC element.</p> <p><b>DBVersion</b> The DB version of the TC element.</p> <p><b>UplinkMode</b> The uplink mode of the TC element.</p> <p><b>StaticPtvCheckState</b> The static PTV check state of the TC element.</p> <p><b>DynamicPtvCheckState</b> The dynamic PTV check state of the TC element.</p> <p><b>CevCheckState</b> The CEV check state of the TC element.</p>
<p>namespace</p>	<p><a href="http://edds.egos.esa/model">http://edds.egos.esa/model</a></p>
<p>children</p>	<p><a href="#">CommandName</a> <a href="#">Domain</a> <a href="#">Source</a> <a href="#">Description</a> <a href="#">SequenceName</a> <a href="#">ReleaseTime</a> <a href="#">UplinkTime</a> <a href="#">ExecutionTime</a> <a href="#">SubSystemId</a> <a href="#">SubScheduleId</a> <a href="#">PUSServiceType</a> <a href="#">PUSSubServiceType</a> <a href="#">ApId</a> <a href="#">Pid</a> <a href="#">Vcid</a> <a href="#">Category</a> <a href="#">GroundStationId</a> <a href="#">SSC</a> <a href="#">DBVersion</a> <a href="#">UplinkMode</a> <a href="#">StaticPtvCheckState</a> <a href="#">DynamicPtvCheckState</a> <a href="#">CevCheckState</a></p>

	<a href="#">isInGroup</a> <a href="#">isGroupEnd</a> <a href="#">isInBlock</a> <a href="#">isBlockEnd</a> <a href="#">InterlockType</a> <a href="#">InterlockStageType</a> <a href="#">SrcType</a> <a href="#">FrameCount</a> <a href="#">TransmissionCount</a> <a href="#">ReleaseState</a> <a href="#">GroundState</a> <a href="#">UplinkState</a> <a href="#">OnBoardState</a> <a href="#">OnBoardAccState</a> <a href="#">ExecStartRTState</a> <a href="#">ExecStartPBState</a> <a href="#">ExecStep1RTState</a> <a href="#">ExecStep1PBState</a> <a href="#">ExecStep2RTState</a> <a href="#">ExecStep2PBState</a> <a href="#">ExecCompState</a> <a href="#">ExecCompPBState</a> <a href="#">TtObgStatus</a> <a href="#">CustomField</a> <a href="#">PktTcReportParameterList</a>
used by	element <b>PktTcReportList/PktTcReportListElement</b>

### I.17 complexType CustomField

diagram	
type	<a href="#">CustomField</a>
properties	isRef 0 minOcc 0 maxOcc unbounded content complex
children	<a href="#">FieldName</a> <a href="#">FieldType</a> <a href="#">Value</a>
annotation	documentation A list of custom TC fields

### I.18 complexType PktTcReportParameterList

diagram	
namespace	http://edds.egos.esa/model
children	<b>PktTcReportParameterListElement</b>
used by	element <b>PktTcReportListElement/PktTcReportParameterList</b>
annotation	documentation A list of the parameters contained in this TC command

### I.19 complexType PktTcReportParameterListElement

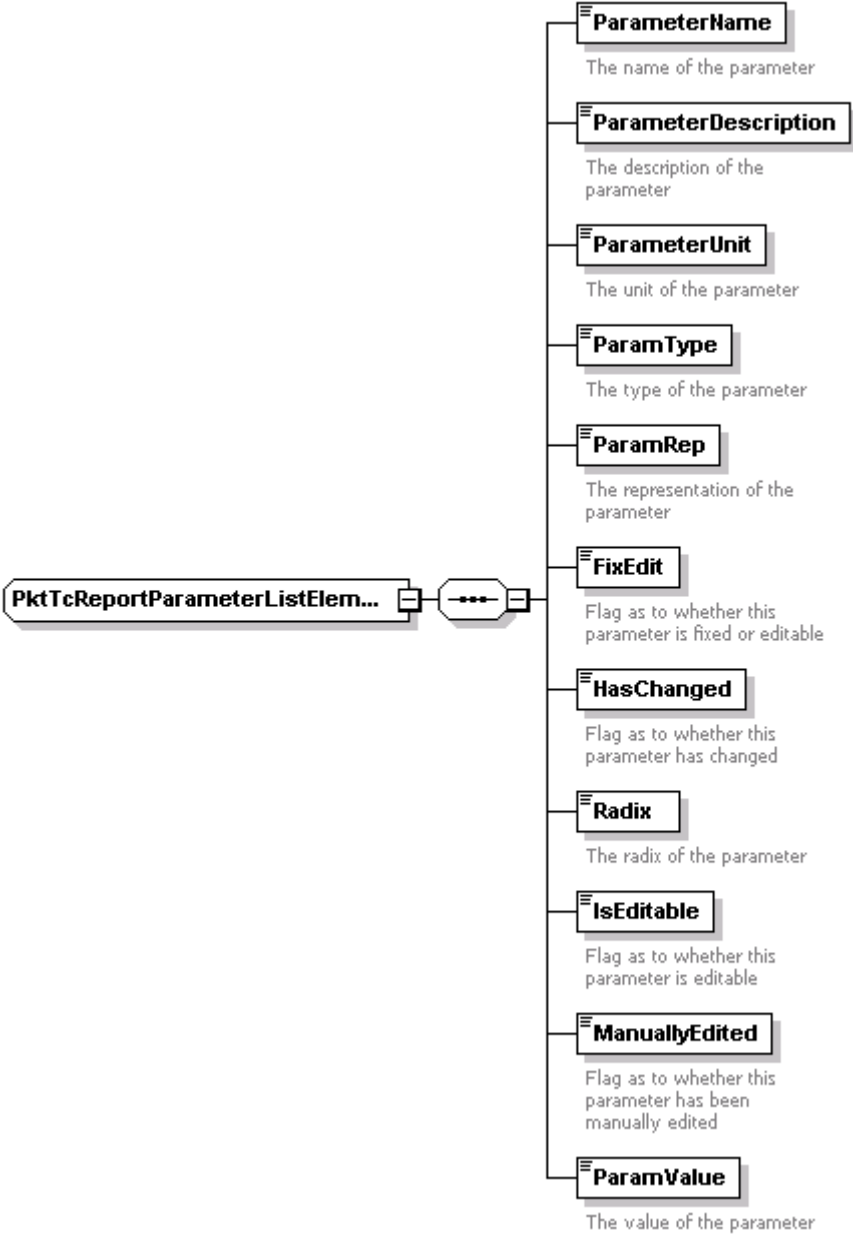
<p>diagram</p>	 <p><b>ParameterName</b> The name of the parameter</p> <p><b>ParameterDescription</b> The description of the parameter</p> <p><b>ParameterUnit</b> The unit of the parameter</p> <p><b>ParamType</b> The type of the parameter</p> <p><b>ParamRep</b> The representation of the parameter</p> <p><b>FixEdit</b> Flag as to whether this parameter is fixed or editable</p> <p><b>HasChanged</b> Flag as to whether this parameter has changed</p> <p><b>Radix</b> The radix of the parameter</p> <p><b>IsEditable</b> Flag as to whether this parameter is editable</p> <p><b>ManuallyEdited</b> Flag as to whether this parameter has been manually edited</p> <p><b>ParamValue</b> The value of the parameter</p>
<p>namespace</p>	<p>http://edds.egos.esa/model</p>
<p>children</p>	<p>ParameterName ParameterDescription ParameterUnit ParamType ParamRep FixEdit HasChanged Radix IsEditable ManuallyEdited ParamValue</p>
<p>used by</p>	<p>element PktTcReportParameterList/PktTcReportParameterListElement</p>

### I.20 complexType PktTcReportResponse

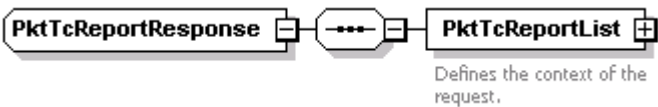
<p>diagram</p>	 <p>Defines the context of the request.</p>
<p>namespace</p>	<p>http://edds.egos.esa/model</p>



children	<b>PktTcReportList</b>
----------	------------------------

### I.21 complexType PktTmReport

diagram	<pre> classDiagram     class PktTmReport {         -     }     class DataRequestBase {         +DataSource         +RequestPostProcessing         +Delivery     }     class TmPacketFilter {         +ReportFormat     }     PktTmReport .. &gt; DataRequestBase     PktTmReport .. &gt; TmPacketFilter     DataRequestBase .. &gt; DataSource     DataRequestBase .. &gt; RequestPostProcessing     DataRequestBase .. &gt; Delivery     TmPacketFilter .. &gt; ReportFormat             </pre>
namespace	http://edds.egos.esa/model
type	extension of <a href="#">DataRequestBase</a>
properties	base DataRequestBase
children	<b>DataSource RequestPostProcessing Delivery TmPacketFilter ReportFormat</b>
annotation	documentation Defines filter to be applied for the TM report

### I.22 complexType PktTmReportList

diagram	<pre> classDiagram     class PktTmReportList {         -     }     class PktTmReportListElement {         +     }     PktTmReportList .. &gt; PktTmReportListElement             </pre>
namespace	http://edds.egos.esa/model
children	<b>PktTmReportListElement</b>
used by	element <b>PktTmReportResponse/PktTmReportList</b>
annotation	documentation A list of TM packets

### I.23 complexType PktTmReportListElement

<p>diagram</p>	<p><b>Apid</b> The APID of the TM command</p> <p><b>Pid</b> The PID of the TM command</p> <p><b>Category</b> The category of the TM command</p> <p><b>DatabaseVersion</b> The database version of the TM command</p> <p><b>GenerationTime</b> The generation time of the TM command</p> <p><b>DataStream</b> The datastream of the TM command</p> <p><b>Domain</b> The domain of the TM command</p> <p><b>GroundStation</b> The ground station of the TM command</p> <p><b>QualityFlag</b> The quality flag of the TM command</p> <p><b>ReceptionTime</b> The reception time of the TM command</p> <p><b>SleServiceId</b> The SLE Service ID of the TM command</p> <p><b>SourceSequenceCounter</b> The source sequence counter (SSC) of the TM command</p> <p><b>Spid</b> The SPID of the TM command</p> <p><b>Type</b> The service type of the TM command</p> <p><b>SubType</b> The sub type of the TM command</p> <p><b>TimeQuality</b> The time quality flag of the TM command, GOOD, INACCURATE or BAD.</p> <p><b>VirtualChannel</b> The virtual channel of the TM command</p> <p><b>DataUnitType</b> The data unit type</p> <p><b>P1</b> The P11 of the TM command</p> <p><b>P12</b> The P12 of the TM command</p> <p><b>PacketLength</b> The length of the TM command</p> <p><b>Mnemonic</b> The mnemonic of the TM command</p> <p><b>Description</b> The description of the TM command</p> <p><b>Id</b> The ID of the TM command. Only present for Spacecraft Events packets.</p>
<p>namespace</p>	<p><a href="http://edds.egos.esa/model">http://edds.egos.esa/model</a></p>
<p>children</p>	<p><b>Apid Pid Category DatabaseVersion GenerationTime DataStream Domain GroundStation QualityFlag ReceptionTime SleServiceId SourceSequenceCounter Spid Type SubType TimeQuality VirtualChannel</b></p>

	<b>DataUnitType Pi1 Pi2 PacketLength Mnemonic Description Id</b>
used by	element <b>PktTmReportList/PktTmReportListElement</b>

### I.24 complexType PktTmReportResponse

diagram	
namespace	http://edds.egos.esa/model
children	<b>PktTmReportList</b>

### I.25 complexType PktTmGapReportList

diagram	
namespace	http://edds.egos.esa/model
children	<a href="#">PktTmGapReportListElement</a>
used by	element <a href="#">PktTmGapReportResponse/PktTmGapReportList</a>

### I.26 complexType PktTmGapReportListElement

diagram	
namespace	http://edds.egos.esa/model
children	<a href="#">StartGapTime</a> <a href="#">EndGapTime</a> <a href="#">Apid</a> <a href="#">DataPartition</a> <a href="#">StartSscPkt</a> <a href="#">EndSscPkt</a> <a href="#">NumPktsMissing</a>

used by	element <a href="#">PktTmGapReportList/PktTmGapReportListElement</a>
---------	--

## ***1.27 complexType PktTmGapReportResponse***

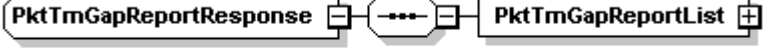
diagram	 <p>Defines the context of the request.</p>
namespace	<a href="http://edds.egos.esa/model">http://edds.egos.esa/model</a>
children	<a href="#">PktTmGapReportList</a>

## Appendix J Schedule Data Type

This section of the document describes the complex types used for scheduling as defined in the schedule.xsd file.

### J.1 complexType EndTime

<p>diagram</p>	<p><b>EndTime</b> Defines the criteria choice to terminate a repeating schedule</p> <ul style="list-style-type: none"> <li><b>FinalDate</b> Defines the absolute end time of the scheduled request</li> <li><b>FinalDOYDate</b> Defines the absolute end time of the scheduled request in DOY format</li> <li><b>Delta</b> Defines a relative end time that will be considered starting from the first time.</li> <li><b>NumberOfRepetition</b> Defines the maximum number of repetition</li> </ul>
<p>namespace</p>	<p>http://edds.egos.esa/model</p>
<p>children</p>	<p><b>FinalDate FinalDOYDate Delta NumberOfRepetition</b></p>
<p>used by</p>	<p>element <b>RepeatingSchedule/EndTime</b></p>
<p>annotation</p>	<p>documentation Defines the criteria choice to terminate a repeating schedule</p>

### J.2 complexType OnceSchedule

<p>diagram</p>	<p><b>OnceSchedule</b> Defines the starting condition of a scheduled request.</p> <ul style="list-style-type: none"> <li><b>AbsoluteTime</b> the absolute time of the request execution</li> <li><b>AbsoluteDOYTime</b> the absolute time of the request execution in DOY format</li> <li><b>RelativeTime</b> A relative time that will be considered starting from the execution time.</li> </ul>
<p>namespace</p>	<p>http://edds.egos.esa/model</p>
<p>children</p>	<p><b>AbsoluteTime AbsoluteDOYTime RelativeTime</b></p>
<p>used by</p>	<p>elements <b>ScheduleOnce/Once ScheduleWithExpiry/RequestExpiryDate RepeatingSchedule/StartTime</b></p>

annotation	documentation Defines the starting condition of a scheduled request.
------------	---

### J.3 complexType RepeatingSchedule

diagram	<p>Defines the time that the request should be started and, any recurring properties of the request.</p> <p><b>StartTime</b> First occurrence of the request</p> <p><b>Repetition</b> How the request should be repeated</p> <p><b>EndTime</b> Last occurrence of the request</p>
namespace	http://edds.egos.esa/model
children	<b>StartTime Repetition EndTime</b>
used by	element <b>ScheduleRepeating/RepeatingSchedule</b>
annotation	documentation Defines the time that the request should be started and, any recurring properties of the request.

### J.4 complexType Repetition

diagram	<p><b>Repetition</b></p> <p><b>CronExpression</b> The cron expression to be used in order for the scheduling period. For a detailed description of the format refer to the Quartz Scheduler documentation</p> <p><b>Step</b> The step how often to repeat the current request</p>
namespace	http://edds.egos.esa/model
children	<b>CronExpression Step</b>
used by	element <b>RepeatingSchedule/Repetition</b>

### J.5 complexType Schedule

diagram	<p><b>Schedule</b> Abstract base class for EDDS schedule types.</p>
namespace	http://edds.egos.esa/model
properties	abstract true
used by	complexType <b>ScheduleOnce ScheduleRepeating</b>

annotation	documentation Abstract base class for EDDS schedule types.
------------	---

## J.6 complexType ScheduleOnce

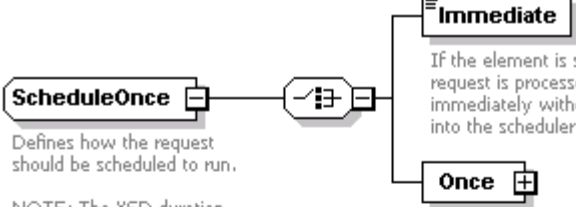
diagram	 <p>Defines how the request should be scheduled to run.</p> <p>NOTE: The XSD duration data type is used to specify a time interval. The time interval is specified in the following form "PnYnMnDnHnMnS" where:</p> <ul style="list-style-type: none"> <li>- P indicates the period (required)</li> <li>- nY indicates the number of years</li> <li>- nM indicates the number of months</li> <li>- nD indicates the number of days</li> <li>- T indicates the start of a time section (required if you are going to specify hours, minutes, or seconds)</li> <li>- nH indicates the number of hours</li> <li>- nM indicates the number of minutes</li> <li>- nS indicates the number of seconds</li> </ul> <p>The following is an example of a duration declaration in a schema:</p> <ul style="list-style-type: none"> <li>- P5Y</li> <li>- P5Y2M10D</li> <li>- P5Y2M10DT15H</li> <li>- PT15H</li> </ul> <p><b>Immediate</b> If the element is selected the request is processed immediately without going into the scheduler.</p> <p><b>Once</b> The request is scheduled to be executed only one time when the associated condition occurs.</p>
namespace	http://edds.egos.esa/model
type	extension of <b>Schedule</b>
properties	base Schedule
children	<b>Immediate Once</b>
used by	complexType <b>ScheduleWithExpiry</b>
annotation	<p>documentation</p> <p>Defines how the request should be scheduled to run.</p> <p>NOTE: The XSD duration data type is used to specify a time interval. The time interval is specified in the following form "PnYnMnDnHnMnS" where:</p> <ul style="list-style-type: none"> <li>- P indicates the period (required)</li> <li>- nY indicates the number of years</li> <li>- nM indicates the number of months</li> <li>- nD indicates the number of days</li> <li>- T indicates the start of a time section (required if you are going to specify hours, minutes, or seconds)</li> <li>- nH indicates the number of hours</li> <li>- nM indicates the number of minutes</li> <li>- nS indicates the number of seconds</li> </ul> <p>The following is an example of a duration declaration in a schema:</p> <ul style="list-style-type: none"> <li>- P5Y</li> <li>- P5Y2M10D</li> <li>- P5Y2M10DT15H</li> <li>- PT15H</li> </ul>

### J.7 complexType ScheduleRepeating

diagram	<p>With this schedule the request is repeated at defined intervals</p> <p>The request is scheduled to be executed more times according to the recurrence conditions.</p>
namespace	http://edds.egos.esa/model
type	extension of <b>Schedule</b>
properties	base <b>Schedule</b>
children	<b>RepeatingSchedule</b>
annotation	documentation With this schedule the request is repeated at defined intervals

### J.8 complexType ScheduleWithExpiry

diagram	<p>Extends the ScheduleOnce schedule type to include the ability to have the request expire</p> <p><b>ScheduleOnce (extension)</b></p> <p><b>Immediate</b> If the element is selected the request is processed immediately without going into the scheduler.</p> <p><b>Once</b> The request is scheduled to be executed only one time when the associated condition occurs.</p> <p><b>RequestExpiryDate</b> The date and time when this subscription request expires (i.e. no more updates are processed for this request)</p>
namespace	http://edds.egos.esa/model
type	extension of <b>ScheduleOnce</b>
properties	base <b>ScheduleOnce</b>
children	<b>Immediate Once RequestExpiryDate</b>
annotation	documentation Extends the ScheduleOnce schedule type to include the ability to have the request expire



## Appendix K User Management Data Type

This section of the document describes the complex types used for user management as defined in the userrequest.xsd file.

### K.1 complexType AccountEnabledDetails

diagram	<pre> classDiagram     class AccountEnabledDetails     class Username     class Role     class Group     class Mission     AccountEnabledDetails "1" -- "*" Username     AccountEnabledDetails "1" -- "*" Role     AccountEnabledDetails "1" -- "*" Group     AccountEnabledDetails "1" -- "*" Mission   </pre>
namespace	http://edds.egos.esa/model
children	Username Role Group Mission
used by	element <b>AccountEnabledDetails</b>

## K.2 *complexType AccountRequest*

<p>diagram</p>	<pre> classDiagram     class AccountRequest {         &lt;&lt;abstract&gt;&gt;     }     class UserAccount {     }     class Group {     }     class Role {     }     class OperationSet {     }     class QuotaSet {     }     class DataAccessSet {     }     class Mission {     }     AccountRequest &lt; -- UserAccount     AccountRequest &lt; -- Group     AccountRequest &lt; -- Role     AccountRequest &lt; -- OperationSet     AccountRequest &lt; -- QuotaSet     AccountRequest &lt; -- DataAccessSet     AccountRequest &lt; -- Mission     </pre> <p>The diagram illustrates the class hierarchy for <b>AccountRequest</b>. It is an abstract class (indicated by a hollow rectangle) that defines the possible account requests and the performed operations. It has seven subclasses, each represented by a solid rectangle with a plus sign in the top right corner:</p> <ul style="list-style-type: none"> <li><b>UserAccount</b>: Defines the requests which allow to monitor and control a user account.</li> <li><b>Group</b>: Defines the requests which allow to monitor and control a user group.</li> <li><b>Role</b>: Defines the requests which allow to monitor and control a user role.</li> <li><b>OperationSet</b>: Defines the requests which allow to monitor and control an operation set.</li> <li><b>QuotaSet</b>: Defines the requests which allow to monitor and control a quota set.</li> <li><b>DataAccessSet</b>: Defines the requests which allow to monitor and control a data access set.</li> <li><b>Mission</b>: Defines the requests which allow to monitor and control a mission.</li> </ul>
<p>namespace</p>	<p><a href="http://edds.egos.esa/model">http://edds.egos.esa/model</a></p>
<p>children</p>	<p><b>UserAccount Group Role OperationSet QuotaSet DataAccessSet Mission</b></p>
<p>used by</p>	<p>element <b>AccountRequestMessagePart/AccountRequest</b></p>
<p>annotation</p>	<p>documentation Defines the possible account requests and the performed operations</p>

### K.3 complexType AccountRequestMessagePart

diagram	
namespace	http://edds.egos.esa/model
children	AccountRequest User MissionId PrivacyTag
used by	element AccountRequestMessagePart
annotation	documentation Define the client message which describes the account management request

### K.4 complexType ContactDetailsElement

diagram	
namespace	http://edds.egos.esa/model
children	Id Email FileServer TargetFolder UserName PostalAddress TelephoneNumber
used by	elements UserAccountBase/ContactDetailsList UserAttributes/ContactDetailsList

### K.5 complexType ContactDetailsList

diagram	
---------	--

namespace	http://edds.egos.esa/model
children	<b>ContactDetailsListElement</b>
used by	elements <b>UserAccountData/ContactDetailsList UserAttributes/ContactDetailsList</b>

### K.6 complexType *DataAccessData*

diagram	
namespace	http://edds.egos.esa/model
children	<b>Name Description DataAccessList</b>
used by	elements <b>DataAccessSet/Create MissionDetailsList/DataAccessDataList DataAccessSet/Update</b>

### K.7 complexType *DataAccessSet*

diagram	
namespace	http://edds.egos.esa/model
children	<b>Create Delete Update</b>
used by	element <b>AccountRequest/DataAccessSet</b>

### K.8 complexType *DataAccessList*

diagram	
namespace	http://edds.egos.esa/model
children	<b>DataAccessElement</b>
used by	element <b>DataAccessData/DataAccessList</b>

### K.9 complexType Group

<p>diagram</p>	<p><b>Group</b> Defines the operations which can be performed to manipulate a user group</p> <ul style="list-style-type: none"> <li><b>Create</b> Allows creating a new user group</li> <li><b>Delete</b> Allows deleting a new user group</li> <li><b>Update</b> Allows modifying a user group</li> <li><b>Suspend</b> Allows suspending a user group (All the users belonging to the group can not perform the login)</li> <li><b>Resume</b> Allows resuming a user group</li> <li><b>Assign</b> Assigns a user group to a role</li> <li><b>Unassign</b> Unassigns a user group from a role</li> </ul>
<p>namespace</p>	<p>http://edds.egos.esa/model</p>
<p>children</p>	<p><b>Create Delete Update Suspend Resume Assign Unassign</b></p>
<p>used by</p>	<p>element <b>AccountRequest/Group</b></p>
<p>annotation</p>	<p>documentation Defines the operations which can be performed to manipulate a user group</p>

### K.10 complexType GroupData

<p>diagram</p>	<p><b>GroupData</b></p> <ul style="list-style-type: none"> <li><b>Name</b></li> <li><b>Description</b></li> <li><b>EnablingStatus</b></li> <li><b>UserList</b> 1..∞</li> <li><b>RoleList</b> 1..∞</li> <li><b>PwdChangeForced</b></li> </ul>
<p>namespace</p>	<p>http://edds.egos.esa/model</p>
<p>children</p>	<p><b>Name Description EnablingStatus UserList RoleList PwdChangeForced</b></p>

used by	elements <b>Group/Create MissionDetailsList/GroupDataList Group/Update</b>
---------	--

### K.11 complexType GroupRoleAssignment

diagram	
namespace	http://edds.egos.esa/model
children	<b>GroupName RoleList</b>
used by	elements <b>Group/Assign Group/Unassign</b>

### K.12 complexType Mission

diagram	
namespace	http://edds.egos.esa/model
children	<b>Create Delete Update</b>
used by	element <b>AccountRequest/Mission</b>

### K.13 complexType MissionData

diagram	
namespace	http://edds.egos.esa/model
children	<b>Name DomainList</b>
used by	elements <b>Mission/Create Mission/Update</b>

### K.14 complexType MissionDetailsList

<p>diagram</p>	
<p>namespace</p>	<p>http://edds.egos.esa/model</p>
<p>children</p>	<p><b>DomainList</b> <b>DataAccessDataList</b> <b>OperationSetDataList</b> <b>QuotaSetDataList</b> <b>GroupDataList</b> <b>UserRoleList</b></p>
<p>used by</p>	<p>element <b>MissionDetails</b></p>
<p>annotation</p>	<p>documentation Combines all details for one mission into one list</p>

### K.15 complexType MissionsList

<p>diagram</p>	
<p>namespace</p>	<p>http://edds.egos.esa/model</p>
<p>children</p>	<p><b>MissionsListElement</b></p>
<p>used by</p>	<p>element <b>MissionsList</b></p>
<p>annotation</p>	<p>documentation The list of missions as defined in the LDAP</p>

### K.16 complexType OperationSet

<p>diagram</p>	
<p>namespace</p>	<p>http://edds.egos.esa/model</p>
<p>children</p>	<p><b>Create</b> <b>Delete</b> <b>Update</b></p>
<p>used by</p>	<p>element <b>AccountRequest/OperationSet</b></p>

**K.17 complexType OperationSetData**

<p>diagram</p>	
<p>namespace</p>	<p>http://edds.egos.esa/model</p>
<p>children</p>	<p><b>Name Description OperationList</b></p>
<p>used by</p>	<p>elements <b>OperationSet/Create MissionDetailsList/OperationSetDataList OperationSet/Update</b></p>

**K.18 complexType QuotaSet**

<p>diagram</p>	
<p>namespace</p>	<p>http://edds.egos.esa/model</p>
<p>children</p>	<p><b>Create Delete Update</b></p>
<p>used by</p>	<p>element <b>AccountRequest/QuotaSet</b></p>



### K.19 complexType QuotaSetData

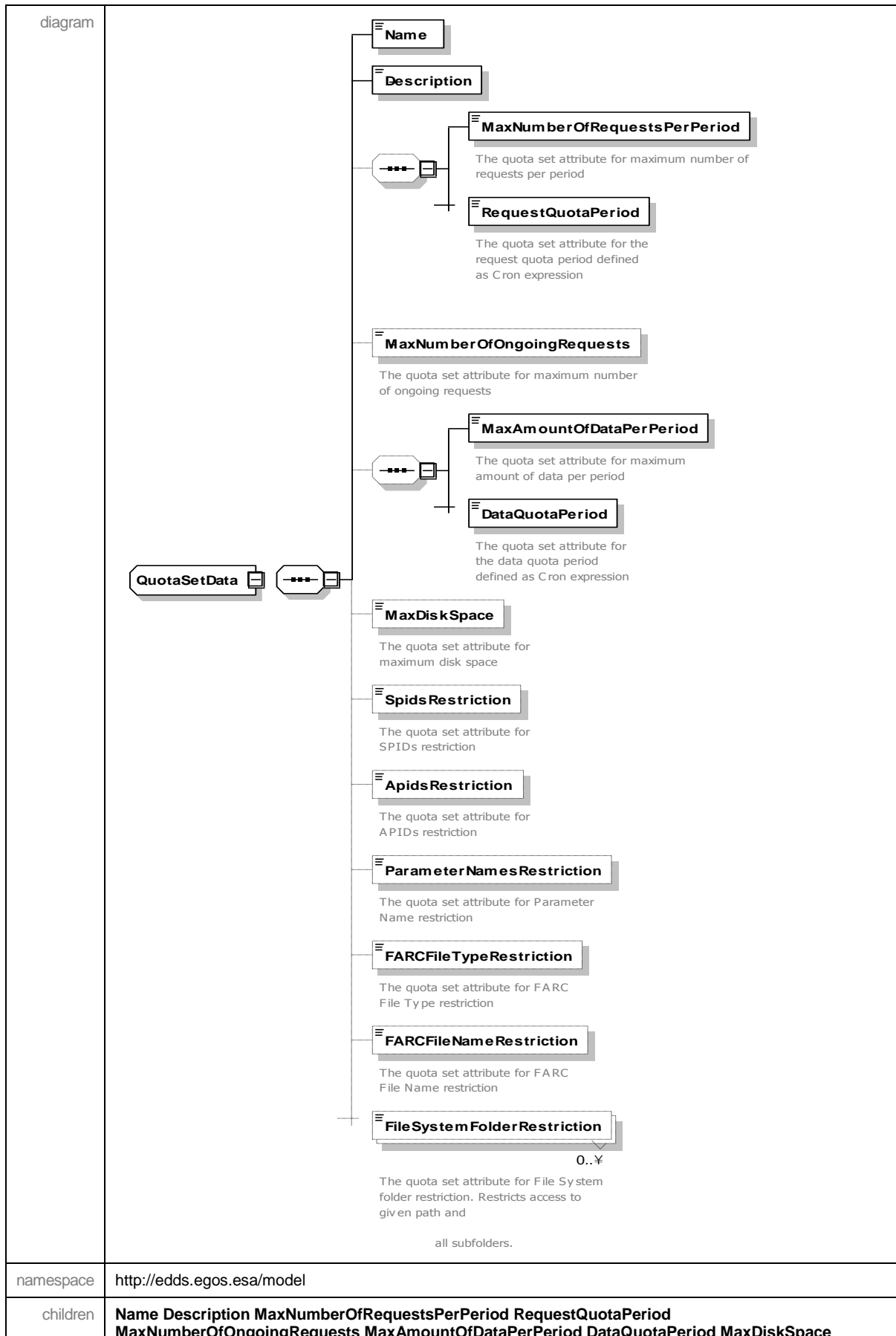

	<b>SpidsRestriction ApidsRestriction ParameterNamesRestriction FARCFileTypeRestriction FARCFileNameRestriction FileSystemFolderRestriction</b>
used by	elements <b>QuotaSet/Create UserQuotaDetails/QuotaLimits MissionDetailsList/QuotaSetDataList QuotaSet/Update</b>

### K.20 complexType QuotaSetRoleAssignment

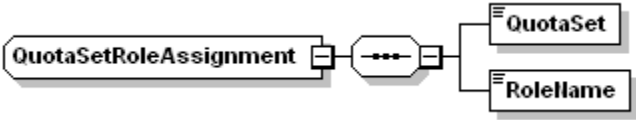
diagram	
namespace	http://edds.egos.esa/model
children	<b>QuotaSet RoleName</b>
used by	elements <b>QuotaSet/Assign QuotaSet/Unassign</b>

### K.21 complexType Role

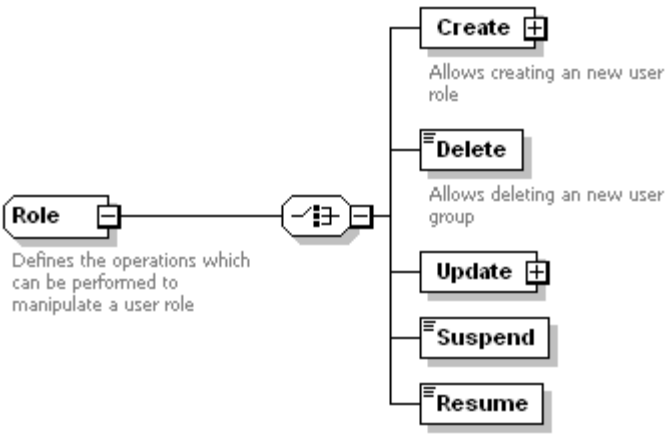
diagram	
namespace	http://edds.egos.esa/model
children	<b>Create Delete Update Suspend Resume</b>
used by	element <b>AccountRequest/Role</b>
annotation	documentation Defines the operations which can be performed to manipulate a user role

### K.22 complexType RolesList

diagram	
namespace	http://edds.egos.esa/model
children	<b>RoleElement</b>
used by	element <b>RolesList</b>
annotation	documentation The list of roles a user has permission to use for the specified mission

### K.23 complexType UserAccount

<p>diagram</p>	<p>The diagram illustrates the <b>UserAccount</b> complex type, which defines operations for manipulating a user account. It is connected to a central node that branches into six operations:</p> <ul style="list-style-type: none"> <li><b>Create</b>: Allows creating a new user.</li> <li><b>Delete</b>: Allows deleting a user.</li> <li><b>Update</b>: Allows modifying the details of a user.</li> <li><b>UpdateUserAttributes</b>: Allows modifying the attributes of a user.</li> <li><b>Suspend</b>: Allow suspending a user (No login will be allowed until the user remains suspended).</li> <li><b>Resume</b>: Allow resuming a user.</li> </ul>
<p>namespace</p>	<p><a href="http://edds.egos.esa/model">http://edds.egos.esa/model</a></p>
<p>children</p>	<p><b>Create Delete Update UpdateUserAttributes Suspend Resume</b></p>
<p>used by</p>	<p>element <b>AccountRequest/UserAccount</b></p>
<p>annotation</p>	<p>documentation Defines the operations which can be performed to manipulate a user account</p>

### K.24 complexType UserAccountBase

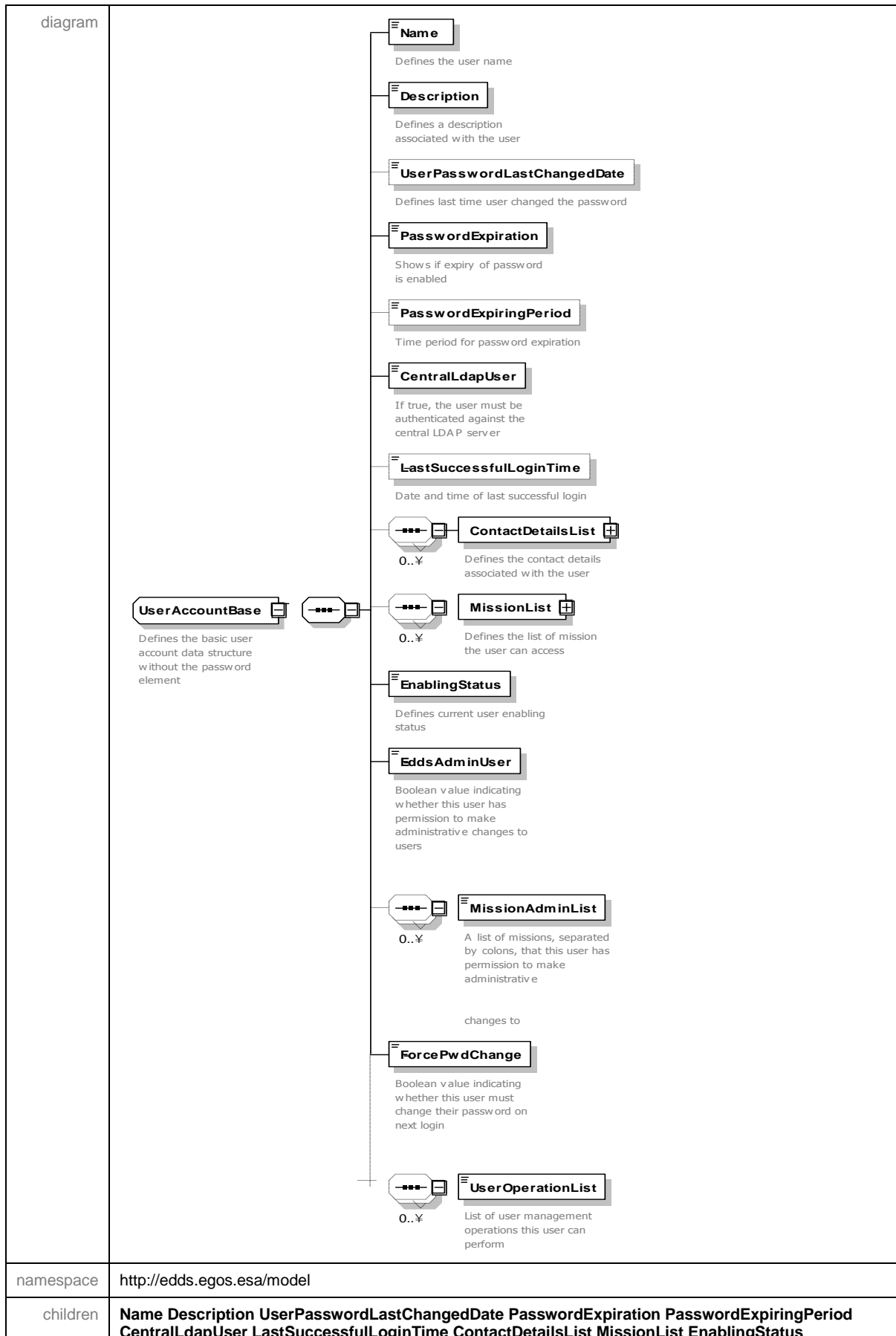

	<b>EddsAdminUser MissionAdminList ForcePwdChange UserOperationList</b>
used by	complexTypes <a href="#">UserAccountCreate</a> <a href="#">UserAccountDetails</a>
annotation	documentation Defines the basic user account data structure without the password element

### K.25 complexType UserAccountCreate

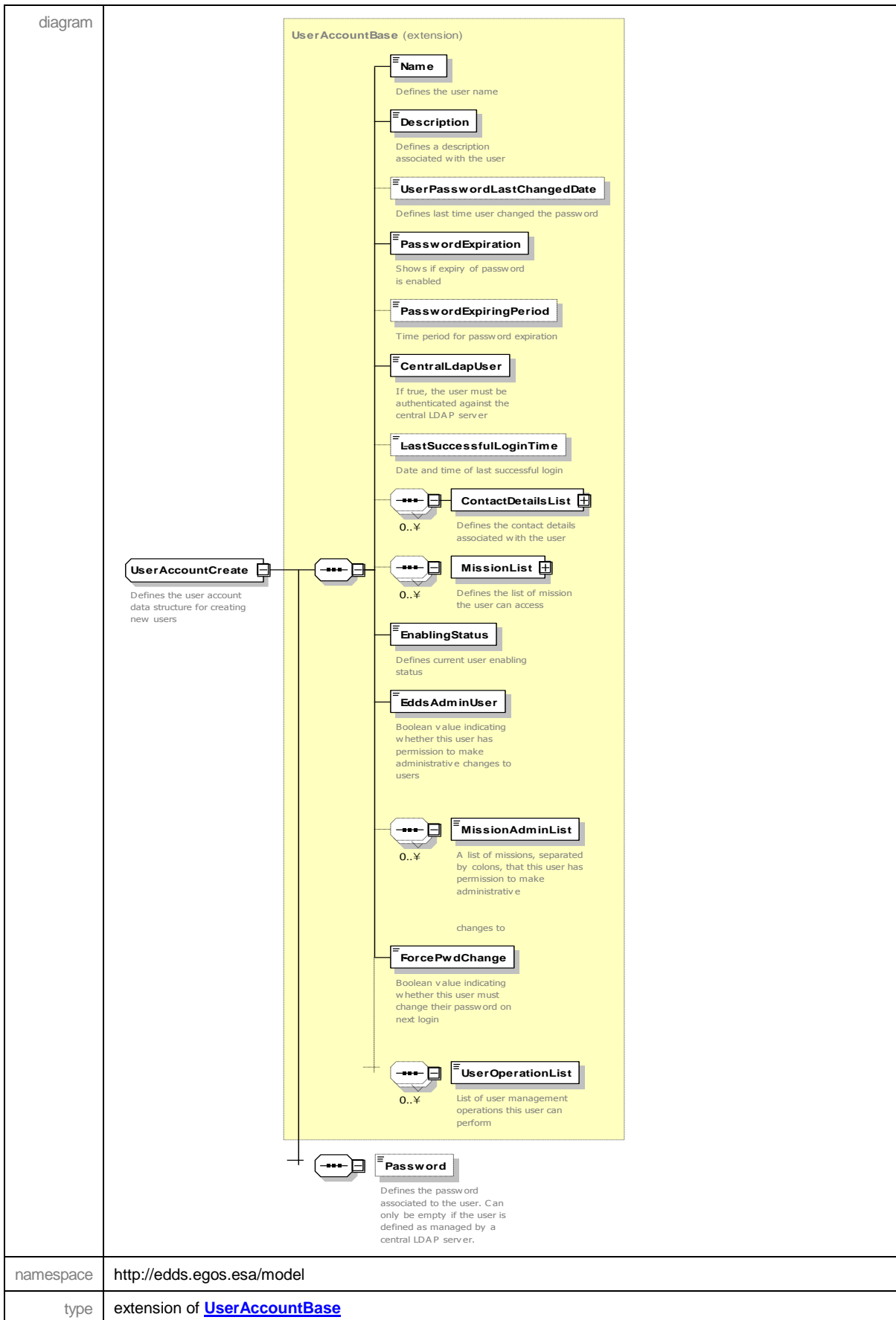

properties	base <b>UserAccountBase</b>
children	<b>Name Description UserPasswordLastChangedDate PasswordExpiration PasswordExpiringPeriod CentralLdapUser LastSuccessfulLoginTime ContactDetailsList MissionList EnablingStatus EddsAdminUser MissionAdminList ForcePwdChange UserOperationList Password</b>
used by	element <b>UserAccount/Create</b>
annotation	documentation Defines the user account data structure for creating new users

### K.26 complexType UserAccountDetails

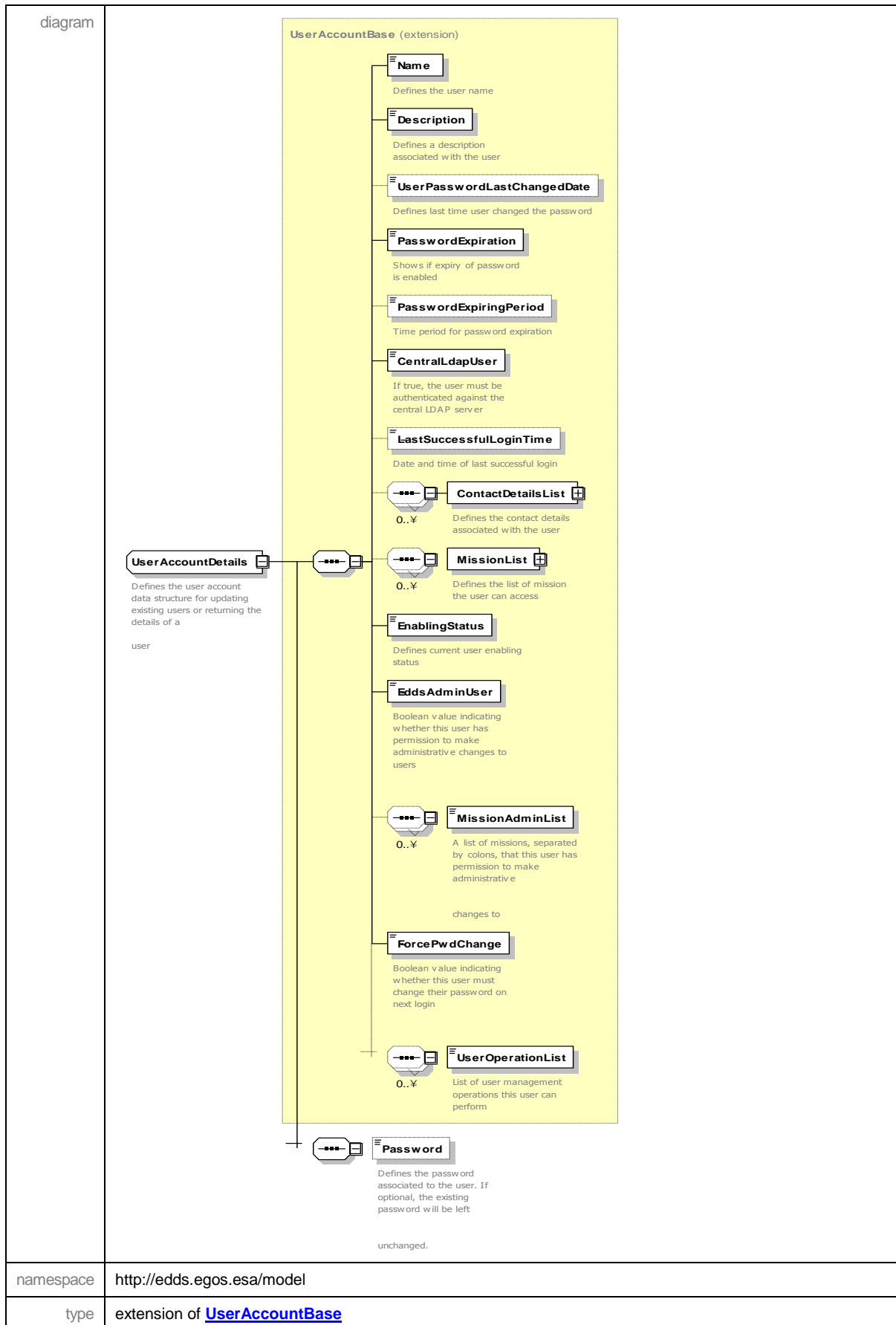



properties	base UserAccountBase
children	<b>Name Description UserPasswordLastChangedDate PasswordExpiration PasswordExpiringPeriod CentralLdapUser LastSuccessfulLoginTime ContactDetailsList MissionList EnablingStatus EddsAdminUser MissionAdminList ForcePwdChange UserOperationList Password</b>
used by	elements <b>UserAccount/Update UserAccountDetails</b>
annotation	documentation Defines the user account data structure for updating existing users or returning the details of a user

**K.27 complexType UserAttributes**

diagram	<p><b>UserAttributes</b> Allows the currently logged in (non-EDDS Admin user) to update a subset of their account data</p> <p><b>Name</b> Defines the user name. This cannot be changed and is for looking up the account to change.</p> <p><b>Description</b> Defines a description associated with the user</p> <p><b>Password</b> Defines the password associated to the user</p> <p><b>ForcePwdChange</b> Boolean value indicating whether this user must change their password on next login</p> <p><b>ContactDetailsList</b> Defines the contact details associated with the user 0..∞</p>
namespace	http://edds.egos.esa/model
children	<b>Name Description Password ForcePwdChange ContactDetailsList</b>
used by	element <b>UserAccount/UpdateUserAttributes</b>
annotation	documentation Allows the currently logged in (non-EDDS Admin user) to update a subset of their account data

**K.28 complexType UserMissionElement**

diagram	<p><b>UserMissionElement</b></p> <p><b>MissionId</b></p> <p><b>RoleList</b> 1..∞</p>
namespace	http://edds.egos.esa/model
children	<b>MissionId RoleList</b>
used by	element <b>UserAccountBase/MissionList</b>

### K.29 complexType UserQuotaDetails

<p>diagram</p>	
<p>namespace</p>	<p>http://edds.egos.esa/model</p>
<p>children</p>	<p><b>Role RequestsInPeriod RequestsLastUpdated OngoingRequests DataInPeriod DataLastUpdated DiskSpaceUsed QuotaLimits</b></p>
<p>used by</p>	<p>element <b>UserQuotaDetailsList/QuotaUsageListElement</b></p>

### K.30 complexType UserQuotaDetailsList

<p>diagram</p>	
<p>namespace</p>	<p>http://edds.egos.esa/model</p>
<p>children</p>	<p><b>QuotaUsageListElement</b></p>
<p>used by</p>	<p>element <b>UserQuotaDetails</b></p>
<p>annotation</p>	<p>documentation List of user quota detail elements</p>

### K.31 complexType UserRole

diagram	
namespace	http://edds.egos.esa/model
children	<b>Name Description OperationSet DataAccessSet QuotaSet Priority EnablingStatus</b>
used by	elements <b>Role/Create Role/Update MissionDetailsList/UserRoleList</b>

### K.32 complexType UsersList

diagram	
namespace	http://edds.egos.esa/model
children	<b>UsersListElement</b>
used by	element <b>UsersList</b>
annotation	documentation The list of users as defined in the LDAP

### K.33 simpleType OperationElement

namespace	http://edds.egos.esa/model																					
type	restriction of <b>xs:string</b>																					
properties	base <b>xs:string</b>																					
used by	element <b>OperationSetData/OperationList</b>																					
facets	<table border="0"> <tr> <td>Kind</td> <td>Value</td> <td>annotation</td> </tr> <tr> <td>enumeration</td> <td>CREATE_GROUP</td> <td></td> </tr> <tr> <td>enumeration</td> <td>DELETE_GROUP</td> <td></td> </tr> <tr> <td>enumeration</td> <td>UPDATE_GROUP</td> <td></td> </tr> <tr> <td>enumeration</td> <td>ASSIGN_ROLE_TO_GROUP</td> <td></td> </tr> <tr> <td>enumeration</td> <td>UNASSIGN_ROLE_FROM_GROUP</td> <td></td> </tr> <tr> <td>enumeration</td> <td>SUSPEND_GROUP</td> <td></td> </tr> </table>	Kind	Value	annotation	enumeration	CREATE_GROUP		enumeration	DELETE_GROUP		enumeration	UPDATE_GROUP		enumeration	ASSIGN_ROLE_TO_GROUP		enumeration	UNASSIGN_ROLE_FROM_GROUP		enumeration	SUSPEND_GROUP	
Kind	Value	annotation																				
enumeration	CREATE_GROUP																					
enumeration	DELETE_GROUP																					
enumeration	UPDATE_GROUP																					
enumeration	ASSIGN_ROLE_TO_GROUP																					
enumeration	UNASSIGN_ROLE_FROM_GROUP																					
enumeration	SUSPEND_GROUP																					

enumeration	RESUME_GROUP
enumeration	CREATE_ROLE
enumeration	DELETE_ROLE
enumeration	UPDATE_ROLE
enumeration	SUSPEND_ROLE
enumeration	RESUME_ROLE
enumeration	UPDATE_ROLE_DEFAULT_CONTACT_DETAILS
enumeration	CREATE_OPERATIONS_SET
enumeration	DELETE_OPERATIONS_SET
enumeration	UPDATE_OPERATIONS_SET
enumeration	ASSIGN_OPERATIONS_SET_TO_ROLE
enumeration	UNASSIGN_OPERATIONS_SET_FROM_ROLE
enumeration	CREATE_DATA_ACCESS_SET
enumeration	DELETE_DATA_ACCESS_SET
enumeration	UPDATE_DATA_ACCESS_SET
enumeration	ASSIGN_DATA_ACCESS_SET_TO_ROLE
enumeration	UNASSIGN_DATA_ACCESS_SET_FROM_ROLE
enumeration	CREATE_QUOTA_SET
enumeration	DELETE_QUOTA_SET
enumeration	UPDATE_QUOTA_SET
enumeration	ASSIGN_QUOTA_SET_TO_ROLE
enumeration	UNASSIGN_QUOTA_SET_FROM_ROLE
enumeration	SCHEDULE_REQUEST
enumeration	VIEW_LOG_FILE

### ***K.34 simpleType UserOperationElement***

namespace	http://edds.egos.esa/model		
type	restriction of <b>xs:string</b>		
properties	base	xs:string	
used by	element	<b>UserAccountBase/UserOperationList</b>	
facets	Kind	Value	annotation
	enumeration	CREATE_USER_ACCOUNT	
	enumeration	DELETE_USER_ACCOUNT	
	enumeration	UPDATE_USER_ACCOUNT	
	enumeration	UPDATE_USER_PERSONAL_ATTRIBUTES	
	enumeration	SUSPEND_USER_ACCOUNT	
	enumeration	RESUME_USER_ACCOUNT	

## Appendix L Stream Request Data Type

This section of the document describes the complex types used for stream requests as defined in the streamrequest.xsd file.

### L.1 complexType OolStream

<p>diagram</p>	<p><b>OolStream</b> Defines the Out Of Limits stream data request</p> <p><b>PktStream (extension)</b></p> <p><b>DataSource</b> Defines the data source associated with the request</p> <p><b>OolStreamFilter</b> (0..∞) Defines the basic information necessary to retrieve the out of limit data from the PARC archive and defines the filter to be applied to the retrieved data.</p>
<p>namespace</p>	<p>http://edds.egos.esa/model</p>
<p>type</p>	<p>extension of <a href="#">PktStream</a></p>
<p>properties</p>	<p>base PktStream</p>
<p>children</p>	<p><b>OolStreamFilter</b></p>
<p>annotation</p>	<p>documentation Defines the Out Of Limits stream data request</p>

### L.2 complexType ParamStream

<p>diagram</p>	<p><b>ParamStream</b> Defines the Parameter stream data request</p> <p><b>StreamDataRequest (extension)</b></p> <p><b>DataSource</b> Defines the data source associated with the request</p> <p><b>ParamNameList</b></p> <p><b>ParamTmStreamFilter</b> (0..∞) Defines the basic information necessary to retrieve the Parameter data from the DARC archive and defines the filter to be applied to the retrieved data.</p>
<p>namespace</p>	<p>http://edds.egos.esa/model</p>
<p>type</p>	<p>extension of <a href="#">StreamDataRequest</a></p>
<p>properties</p>	<p>base StreamDataRequest</p>

children	<b>ParamNameList ParamTmStreamFilter</b>
annotation	documentation Defines the Parameter stream data request

### L.3 complexType PktEvStream

diagram	<p><b>PktEvStream</b> Defines the Packet EV stream data request (for SCOS Event log messages)</p> <p><b>PktStream (extension)</b> Defines the data source associated with the request</p> <p><b>EvStreamFilter</b> 0..∞ Defines the basic information necessary to retrieve the SCOS Event Log data from the PARC archive and defines the filter to be applied to the retrieved data.</p>
namespace	http://edds.egos.esa/model
type	extension of <a href="#">PktStream</a>
properties	base PktStream
children	<b>EvStreamFilter</b>
annotation	documentation Defines the Packet EV stream data request (for SCOS Event log messages)

### L.4 complexType PktStream

diagram	<p><b>PktStream</b> Abstract base class for EDDS packet stream request types</p> <p><b>StreamDataRequest (extension)</b> Defines the data source associated with the request</p>
namespace	http://edds.egos.esa/model
type	extension of <a href="#">StreamDataRequest</a>
properties	base StreamDataRequest abstract true
used by	complexTypes <a href="#">OolStream</a> <a href="#">PktEvStream</a> <a href="#">PktTcStream</a> <a href="#">PktTmStream</a>
annotation	documentation Abstract base class for EDDS packet stream request types

## L.5 complexType PktTcStream

diagram	<p><b>PktTcStream</b> Defines the Packet TC stream data request (for telecommands)</p> <p><b>PktStream (extension)</b></p> <p><b>DataSource</b> Defines the data source associated with the request</p> <p><b>TcStreamFilter</b> Defines the basic information necessary to retrieve the telecommand data from the PARC archive and defines the filter to be applied to the retrieved data. 0..∞</p>
namespace	http://edds.egos.esa/model
type	extension of <a href="#">PktStream</a>
properties	base PktStream
children	<b>TcStreamFilter</b>
annotation	documentation Defines the Packet TC stream data request (for telecommands)

## L.6 complexType PktTmStream

diagram	<p><b>PktTmStream</b> Defines the Packet TM stream data request (for telemetry)</p> <p><b>PktStream (extension)</b></p> <p><b>DataSource</b> Defines the data source associated with the request</p> <p><b>PacketNameList</b> Defines the Packets which have to be retrieved</p> <p><b>TmStreamFilter</b> Defines the basic information necessary to retrieve the telemetry data from the PARC archive and defines the filter to be applied to the retrieved data. 0..∞</p>
namespace	http://edds.egos.esa/model
type	extension of <a href="#">PktStream</a>
properties	base PktStream
children	<b>PacketNameList TmStreamFilter</b>
annotation	documentation Defines the Packet TM stream data request (for telemetry)

### L.7 complexType StreamDataRequest

diagram	<p><b>StreamDataRequest</b> Abstract base class for EDDS stream request types, defines the specific stream data requested in the StreamRequest</p> <p><b>DataSource</b> Defines the data source associated with the request</p>
namespace	http://edds.egos.esa/model
properties	abstract true
children	<b>DataSource</b>
used by	element <b>StreamRequest/StreamDataRequest</b> complexType <a href="#">ParamStream PktStream</a>
annotation	documentation Abstract base class for EDDS stream request types, defines the specific stream data requested in the StreamRequest

### L.8 complexType StreamRequest

diagram	<p><b>StreamRequest</b> Defines the structure and content of a stream request.</p> <p><b>Comment</b> Comments associated with the Batch Request.</p> <p><b>Schedule</b> Defines how the request should be scheduled to run.</p> <p><b>User</b> Defines the user details.</p> <p><b>StreamDataRequest</b> Defines the stream data request.</p>
namespace	http://edds.egos.esa/model
children	<b>Comment Schedule User StreamDataRequest</b>
used by	element <b>StreamRequestMessagePart/StreamRequest</b>
annotation	documentation Defines the structure and content of a stream request.

### L.9 complexType StreamRequestMessagePart

diagram	<p><b>StreamRequestMessagePart</b> Defines the stream request message the client submits to server</p> <p><b>ContextPart</b> Defines the context of the request.</p> <p><b>StreamRequest</b> Defines the stream request.</p>
namespace	http://edds.egos.esa/model
children	<b>ContextPart StreamRequest</b>
used by	element <b>StreamRequestMessagePart</b>
annotation	documentation Defines the stream request message the client submits to server





## Appendix M EDDS Parameter Spreadsheet

### *M.1 TDRS like SpreadSheet*

EDDS provides a sample XSLT file for the Telemetry Parameter batch request so that the TDRS spreadsheet format can be created from the retrieved XML. The file is called "Param.xsl" and can be modified to each mission's needs. The file is deployed by default into the EDDS Server runtime directory within "config/XSLT". The filename must match the report type. More details on the format of the generated TDRS spreadsheet file can be found in the file "TDRS External Interfaces Control Document" [RD-14]

The following fields are included in the output of the TDRS spreadsheet file, but are only filled with dummy values as the information cannot be obtained yet these fields are mandatory in the TDRS ICD:

- Retrieval ID (always set to 0);
- Execution ID (always set to 0);
- Expiration day (always set to 0).

The values can be changed by editing the XSLT file.

As the XSLT file must load the XML data into memory to be able to create the TDRS output file, EDDS also provides a native TDRS format that can work with much larger amounts of data. This format can be selected on the Parameter TM Format request and optionally the number of decimal places can be limited under the TDRS Options section. By default, EDDS will not limit the number of decimal places and so the data will be as received from the DARC/SMON. The restrictions above regarding the mandatory fields that cannot be populated remain in place, except the Retrieval ID is set to the EDDS Request ID.

### *M.2 Presto Plot Stylesheet*

The style sheet for transforming XML results are mission specific and provided by the mission, and so considered out of the scope of this document.

## Appendix N Google Protocol Buffers

### N.1 Introduction

EDDS uses a software library called Google Protocol Buffers internally for use in passing messages between applications as well as for stream data. Google Protocol Buffers offers several advantages over the use of XML; in particular it is considerably faster and smaller than an XML message – an essential requirement for real-time streaming. More information on Google Protocol Buffers can be found here: <http://code.google.com/apis/protocolbuffers/>

EDDS uses the Google Protocol Buffers implementation found within the ActiveMQ library. The proto files (which describe the data structure) are compiled into Java classes when compiling the software from source. The proto files can be found in the project edds-ws-common within src/main/wsd. The class `org/apache/activemq/protobuf/compiler/JavaGenerator` inside the Jar file `activemq-all-5.7.0.jar` is used to compile the proto files. The main method takes the following parameters: --out=<full location to place to put generated classes> <list of proto files to compile>

EDDS uses the `toFramedByteArray()` and `fromFramedByteArray()` methods (of ActiveMQ protobuf implementation) in the compiled proto code for converting the data to a byte array for sending on the payload of a JMS message and reading the data back again on the receiver's end. Several helper classes exist for reading the encoded byte arrays sent from the server to the client. The Java client API also uses these classes for making it easier for users of the API to access the information returned by the web server. The helper classes can be found in `esa.egos.edds.types` within `edds-ws-common`.

There is helper class `DarcParameterBinarySupport` available to simplify reading data from DARC parameter binary response. This class can be found from project `edds-ws-client`.

Here is a list of the proto files within EDDS and their purpose:

Proto file	Description
<code>darcparameter.proto</code>	A record containing information about a DARC parameter as placed on the DARC stream topic
<code>farccatalogue.proto</code>	Contains records containing information about files stored in the FARC
<code>paramdef.proto</code>	A record containing information about a DARC parameter definition
<code>requestinfo.proto</code>	A record containing information about a batch, stream or account request
<code>systemlog.proto</code>	A record containing information about a log message from EDDS
<code>DarcParameterBinary.proto</code>	A record containing information about DARC parameters in Parameter TM request response files in BINARY format
<code>SMONParameter.proto</code>	A record containing information about TM parameters in SMON Parameter request response files in BINARY format
<code>EventRecordReport.proto</code>	A record containing information about EV data in Event Record Report request response files in BINARY format
<code>PacketRaw.proto</code>	A record containing information about raw data in Packet TC Raw, Packet TM Raw and Packet EV Raw requests response files in BINARY format
<code>PacketTCReport.proto</code>	A record containing information about TC data in Packet TC Report request response files in BINARY format
<code>PacketTMReport.proto</code>	A record containing information about TM data in Packet TM Report request response files in BINARY format